



by Ralph Grabowski

BricsCAD[®]

for AutoCAD[®] Users V20

Payment Information

This book is covered by copyright. As the owner of the copyright, upFront.eZine Publishing, Ltd. gives you permission to make one print copy. You may not make any electronic copies, and you may not claim authorship or ownership of the text or figures herein.

Copyright Information

Copyright © 2019 by upFront.eZine Publishing, Ltd.
All rights reserved worldwide

12th edition Based on BricsCAD V20
First printing 28 October 2019

Technical writer **Ralph Grabowski**
Technical editing **Bricsys Staff**

All brand names and product names mentioned in this book are trademarks or service marks of their respective companies. Any omission or misuse (of any kind) of service marks or trademarks should not be regarded as intent to infringe on the property of others. The publisher recognizes and respects all marks used by companies, manufacturers, and developers as a means to distinguish their products.

This book is sold as is, without warranty of any kind, either express or implied, respecting the contents of this book and any disks or programs that may accompany it, including but not limited to implied warranties for the book's quality, performance, merchantability, or fitness for any particular purpose. Neither the publisher, authors, staff, or distributors shall be liable to the purchaser or any other person or entity with respect to any liability, loss, or damage caused or alleged to have been caused directly or indirectly by this book.

Quick Contents

1. BRICSCAD FOR AUTOCAD USERS	1
2. COMPARING USER INTERFACES BETWEEN AUTOCAD & BRICSCAD	35
3. COMPATIBILITY OF DRAWING ELEMENTS.....	75
4. CUSTOMIZING AND PROGRAMMING BRICSCAD	113
5. OPERATING DUAL-CAD DESIGN OFFICES.....	159
6. WORKING WITH ADVANCED 3D	187
7. BRICSCAD FOR BIM	221
8. BRICSCAD MECHANICAL & COMMUNICATOR.....	241
APPENDICES	
A. AUTOCAD-BRICSCAD COMMAND CROSS-REFERENCE	267
B. SYSTEM VARIABLE CROSS-REFERENCE	297
C. KEYSTROKE & BUTTON CROSS-REFERENCE	335
D. SETTING UP NETWORK LICENSES	347

Table of Contents

AutoCAD-BricsCAD Dictionary..... xiv

1. BricsCAD for AutoCAD Users 1

THE BRICSYS BENEFIT	2
THE AGONY OF AUTOCAD	2
THE BUSINESS OF BRICSYS	3
A Substitute for AutoCAD and AutoCAD LT	4
24/7 Project Management.....	5
Bricsys Shape: Early-Phase Design Software (Free)	6
BricsCAD is Not IntelliCAD.....	6
THE BRICSCAD ADVANTAGE	7
MANY FILE FORMATS VS. UNIVERSAL DWG FORMAT	7
SPEED.....	8
NEAR-IDENTICAL USER INTERFACE.....	8
Extra Commands and System Variables	8
3D Direct Modeling and Constraints.....	10
Artificial Intelligence.....	11
APIS AND CUSTOMIZATION	12
Examples of Add-ons.....	13
No-charge Developer Network.....	14

LOWER PURCHASE AND MAINTENANCE PRICES	15
Keep Your BricsCAD	16
It Makes More than Cents.....	16
WHAT'S MISSING FROM BRICSCAD?	17
What's Missing from AutoCAD	17
SYSTEM REQUIREMENTS.....	19
RECOMMENDED HARDWARE	19
About BricsCAD Network Licenses.....	20
SUPPORT FOR MULTIPLE OPERATING SYSTEMS	21
Supported Operating Systems	21
What's New in BricsCAD V20.....	23

2. Comparing User Interfaces Between AutoCAD & BricsCAD. 35

Comparison of User Interfaces.....	36
Comparison of User Interface Elements.....	38
AUTOCAD AND BRICSCAD START SCREENS	39
LAUNCHER DIALOG (BRICSCAD ONLY).....	39
Start Page	40
COMPARING USER INTERFACES	41
DIALOG BOXES	42
COMPARING ‘:’ AND ‘TYPE A COMMAND’	44
Customizing the Command Prompt (BricsCAD only).....	44
PROMPT MENU (BRICSCAD ONLY).....	45
Controlling the Prompt Menu (BricsCAD only).....	45
Additional Command Options (BricsCAD only).....	46
THE QUAD (BRICSCAD ONLY)	47
Turning On the Quad	47
Displaying Information With the Quad.....	48
Editing Properties With the Quad (BricsCAD only).....	48
Editing Entities with the Quad	49
Drawing With the Quad.....	50
COMPARING OPTIONS AND SETTINGS.....	51
TOURING THE SETTINGS DIALOG BOX.....	52
Using Real-time Search	53
Opening and Closing Nodes.....	53
Change Alerts	54
Read-only Variables	55
Help for Variables	55
Exporting Settings.....	55
Accessing and Moving BricsCAD Panels	56

COMPARING AUTOCAD PALETTES AND BRICSCAD PANELS	57
COMPARING PROPERTIES PANELS.....	58
COMPARING MECHANICAL BROWSER AND PARAMETRICS MANAGER.....	59
Structure Panel (BricsCAD Only)	60
STATUS BAR & OTHER UI DIFFERENCES.....	61
COMPARING STATUS BARS.....	61
WORKING SETS (BRICSCAD ONLY)	64
HOTKEY ASSISTANT (BRICSCAD ONLY)	65
COMPARING VIEW CUBES	66
COMPARING SELECTION SETS.....	67
COMPARING DESIGNCENTER & DRAWING EXPLORER.....	69
Unified Interface.....	70
COMPARING GIZMO AND MANIPULATOR	71
3D MODELING.....	72
COMPARING BRICSYS 24/7 AND AUTODESK 360	72
Using 24/7.....	73

3. Compatibility of Drawing Elements 75

Checklist of DWG2018 Entities	77
-------------------------------------	----

DWG 2018 COMPATIBILITY 78

HOW WE TEST ENTITY COMPATIBILITY	78
Decoding the Legend	78
Constraints	79
Dimensions	79
Dynamic Blocks.....	79
Geographic Location	80
Model Documentation	80
Multilines	81
Proxy Objects.....	81
Sub-d Meshes	81
Tables	81
History of BricsCAD's DWG Support.....	82
Underlays.....	83
Visual Styles	83
MISCELLANEOUS COMPATIBILITY.....	83

DWG2018 ENTITY SUPPORT IN BRICSCAD V20..... 84

2D ENTITIES.....	84
TEXT ENTITIES	87

DIMENSION ENTITIES	88
GEOMETRIC AND DIMENSIONAL CONSTRAINTS	91
COMPLEX 2D ENTITIES	92
3D ENTITIES.....	94
COMPATIBILITY BETWEEN PROPERTIES.....	99
LAYER PROPERTY COMPATIBILITY.....	99
COMPATIBILITY BETWEEN STYLES	101
View Detail and Section Styles.....	101
Dimension Styles	103
Leader and QLeader Styles	103
MText and Text Styles	104
Multiline Styles	106
Multileader Styles.....	106
Plot Styles	107
Section Styles	107
Table Styles	108
Visual Styles	109

4. Customizing and Programming BricsCAD 113

Customization Capabilities..... 114

AUTOCAD OPTIONS VS. BRICSCAD SETTINGS..... 115

 SYSTEM VARIABLES AND PREFERENCES

 FILE PATHS

AUTOCAD CUI VS BRICSCAD CUSTOMIZE116

 UNDERSTANDING BRICSCAD’S CUSTOMIZATION TREE

 How BricsCAD Customizes Menus.....

 Tutorial: How to Add a Command to a Menu

 TIPS FOR WORKING WITH BRICSCAD CUSTOMIZATION.....

 Q: Which commands can be add to menus, toolbars, and so on?

 Q: What’s the difference between “Insert” and “Append”?

 Q: What do I do when I mangle a customization?

 CREATING A NEW MENU ITEM IN BRICSCAD

 Step 1: How to Create Partial Menus in BricsCAD.....

 Step 2: Adding Custom Commands to BricsCAD.....

 About BricsCAD’s Macro Metacharacters.....

 About BricsCAD’s Menu Design Conventions.....

 About Diesel and DCL in BricsCAD.....

 CUSTOMIZING CONTEXT MENUS.....

CUSTOMIZING TOOLBARS	131
CUSTOMIZING RIBBON TABS AND PANELS	132
CUSTOMIZING KEYBOARD SHORTCUTS	133
CUSTOMIZING MOUSE BUTTONS & DOUBLE-CLICKS.....	134
Double-Click Actions.....	135
CUSTOMIZING TABLET BUTTONS AND MENUS.....	136
CUSTOMIZING QUICK PROPERTIES.....	137
CUSTOMIZING THE QUAD	138
CUSTOMIZING WORKSPACES.....	139
CUSTOMIZING ALIASES AND SHELL COMMANDS	140
Shell Commands.....	140
CUSTOMIZING TOOLS PALETTES	141
<i>Legalities: About Copying Files</i>	<i>142</i>
OTHER AREAS OF CUSTOMIZATION	142
FONTS	142
TrueType Fonts.....	142
SHX Fonts.....	143
PFB Fonts.....	143
Font Mapping	143
eTransmit	144
LINETYPES AND HATCH PATTERNS.....	145
Tutorial: How to Copy AutoCAD .lin and .pat Files to BricsCAD.....	145
PLOT STYLES.....	146
Plotter Manager	147
SUPPORTED FILES	148
PROGRAMMING CONSIDERATIONS.....	151
ABOUT BRX.....	152
ABOUT TX.....	152
ABOUT .NET (WINDOWS ONLY)	153
PORTING AUTOLISP TO LISP.....	153
BricsCAD Automation Object Model	154
BricsCAD LISP Advanced Development Environment	155
DOSLib LISP Library.....	156
PORTING DCL TO BRICSCAD	156
Porting Diesel to BricsCAD.....	156
PORTING VBA TO BRICSCAD (WINDOWS ONLY)	156
PORTING ADS TO SDS	156
PORTING COM TO BRICSCAD (WINDOWS ONLY).....	157

LOADING APPLICATIONS INTO BRICSCAD	157
Units.....	157
THIRD-PARTY DEVELOPER SUPPORT	158

5. Operating Dual-CAD Design Offices159

WHY USE MORE THAN ONE CAD SYSTEM?160

LOWER TOTAL COST OF OWNERSHIP	160
Subscription Pros and Cons	162
Country-Biased Pricing.....	162
Solutions to High License Fees	163
MAXIMIZING COMPATIBILITY WITH CLIENTS.....	164
CAPABILITY THROUGH MORE FUNCTIONS	165

RUNNING BRICSCAD & AUTOCAD IN ONE OFFICE 167

DIVIDING WORKFLOWS BETWEEN AUTOCAD & BRICSCAD	167
STRATEGIC IMPLEMENTATION.....	169
COMMON OPERATIONS THROUGH FILE PATHS.....	169
Tutorial: How to Add AutoCAD Support Folder Names to BricsCAD.....	171
USER PROFILES.....	173
Launching BricsCAD with a User Profile.....	174
Tutorial: How to Import AutoCAD Profiles into to BricsCAD.....	175
ROAMING PROFILES	176
AutoCAD Support Folders.....	176
BricsCAD Support Folders.....	176
Tutorial: Importing Menus Files from AutoCAD.....	177
Tutorial: Making Hidden Folders Visible in Windows.....	177
Tutorial: Making Hidden Folders Visible in MacOS	178
Tutorial: Loading AutoCAD’s PGP File into BricsCAD.....	179
Tutorial: How to Export AutoCAD Palettes to BricsCAD	179

THE DUAL OS OFFICE181

SOLVING THE PROBLEM OF PORTING SOFTWARE TO LINUX	181
User Interface	182
APIs	182
BENEFITS OF LINUX.....	183
Linux is Free	183
Linux is Hardware-Efficient	183
Linux Is Malware-free.....	183
Linux is Hardware-compatible	184
Linux Dual-boots.....	184
DRAWBACKS TO LINUX.....	184

Lack of Identical Software	185
Which Linux?	185
Problematic Installers	186
Competing GUIs	186

6. Working With Advanced 3D187

3D Function Comparison	188
BRICSCAD'S DIRECT MODELING VS AUTOCAD'S PRESSPULL	189
BricsCAD Command Name Prefixes.....	190
WORKING WITH DIRECT MODELING	190
Accessing Direct Modeling Commands.....	191
Direct Modeling Tutorial	191
WORKSPACES, 3D VIEWING, QUAD CURSOR,	
MANIPULATE, 3D MOUSE.....	195
SWITCHING WORKSPACES	195
Accessing the Workspace Commands.....	195
VIEW ROTATION & UCS FACE COMMANDS	196
Accessing the 3D Viewing Commands.....	196
VISUAL STYLES	197
Accessing Visual Styles Commands	198
WORKING WITH THE QUAD CURSOR	198
Accessing the Quad Command.....	199
BRICSCAD'S MANIPULATOR VS AUTOCAD'S GIZMO	199
HOTKEY ASSISTANT	200
WORKING WITH A 3D MOUSE.....	201
3D GEOMETRIC & 3D DIMENSIONAL CONSTRAINTS	203
WORKING WITH 3D CONSTRAINTS.....	203
Accessing 3D Constraint Commands.....	203
3D DESIGN INTENT	204
WORKING WITH DESIGN INTENT	205
Accessing Design Intent Commands	207
MECHANICAL BROWSER.....	208
Accessing the Mechanical Browser	209
TOOL PALETTES	209
Accessing the Tools Palette	209

MODELING AND DEFORMING 3D SURFACES	210
Accessing Surfacing Commands.....	210
3D SECTIONS	211
WORKING WITH SECTIONS	211
Accessing the Commands	211
DRAWING VIEWS VS MODEL DOCUMENTATION.....	212
Accessing Generative Drawing Commands	213
BILLS OF MATERIAL VS DATA EXTRACTION	214
HOW BOMs AND BALLOONs WORK IN BRICSCAD	214
EDITING BOMs.....	215
Exploding Assemblies	216
Adding Balloons.....	217
3D COMPARE	218
Accessing the Drawing Compare Command.....	219
7. BricsCAD for BIM	221
3D BIM DESIGN.....	222
TUTORIAL: STARTING A BIM DESIGN	222
Step 1. Drawing the Walls.....	223
<i>Polysolid Turns 2D Lines into 3D Walls.....</i>	224
STEP 2. CLASSIFY WALLS	229
STEP 3. ADD COMPONENTS.....	233
<i>Parametric Sizing.....</i>	234
STEP 4: ADDING STAIRS	236
STEP 5: SHARING THE BUILDING DESIGN	238
Accessing BIM Commands.....	239
8. BricsCAD Mechanical & Communicator.....	241
3D ASSEMBLY MODELING.....	242
Accessing Assembly Commands.....	242
WORKING WITH ASSEMBLIES	243
3D KINEMATIC ANALYSIS	247
MOVEMENT ANALYSIS.....	247

3D SHEET METAL DESIGN.....	249
TUTORIAL I: HOW SHEET METAL DESIGN WORKS	249
Step 1. Create Sheet Metal.....	249
<i>The Color of Sheet Metal.....</i>	249
Step 2. Add Flanges	250
Step 3. Unfold Sheet Metal.....	252
ADDING FORM FEATURES	254
Exporting Sheet Metal Parts.....	255
TUTORIAL II: FROM 3D SOLID TO SHEET METAL	255
Accessing Sheet Metal Commands	262
COMMUNICATOR TRANSLATION	262
Import Formats Supported.....	263
Export Formats Supported	263
Importing & Exporting Without Communicator.....	264
Accessing Import and Export Commands.....	265

Appendices

A. AutoCAD-BricsCAD Command Cross-reference..... 267

BIM MODELING COMMANDS	290
BricsCAD Mechanical Commands.....	292
3D Constraints Commands.....	293
Direct Modeling Commands	294
SHEET METAL MODELING COMMANDS.....	294

B. System Variable Cross-reference

B. Keystroke & Button Cross-reference..... 335

KEYBOARD SHORTCUTS FOR THE DRAWING AREA	336
KEYBOARD SHORTCUTS FOR COMMAND BAR & TEXT WINDOW	340
MOUSE AND TABLET BUTTONS	341
MOUSE BUTTONS	341
TABLET BUTTONS	342
NAVIGATE & 3D WALK-FLY CONTROLS.....	344
3D MOUSE CONTROLS AND BUTTONS.....	345
BricsCAD Customization.....	345

E. Setting Up Network Licenses.....	347
BRICSYS USER ACCOUNT	348
NLM INSTALLATION.....	348
UPGRADING & REPLACING EXISTING LICENSES	349
ADDING ADDITIONAL LICENSES	351
NETWORK MANAGEMENT.....	351
SETTING UP A REPORT LOG	352
DEPLOYMENT.....	353
LICENSE ROAMING	353
BRICSCAD USER SUPPORT	354
KEY TIPS.....	354

..... **AUTOCAD-BRICSCAD DICTIONARY**

BricsCAD's terms closely follow AutoCAD's jargon, but there are a few differences.

AutoCAD Term	BricsCAD Equivalent
ADS	SDS (software development system)
ARX	BRX (BricsCAD runtime extension) TX (Teigha runtime extension)
AutoLISP	LISP
...	Content Browser
Design Center	Drawing Explorer
implied intersection	3dintersection
intersection	2dintersection
macros	tools
model documentation	generative drafting
Navigation Cube or ViewCube	LookFrom widget
object	entity
options	settings
osnap	esnap (short for "entity snap")
palette	panel or bar
shortcut menu	context menu
xdata	EED (extended entity data)

BricsCAD for AutoCAD Users

WELCOME TO THE BOOK THAT HELPS YOU TRANSITION FROM AUTOCAD® TO BRICSCAD.

BricsCAD V20 for AutoCAD Users is for you when you are

- ▶ An AutoCAD user considering, for whatever reason, switching to an AutoCAD workalike
- ▶ A CAD manager adding low-cost licenses of BricsCAD to complement your AutoCAD shop
- ▶ A design firm working with clients who other CAD packages

Here you will learn about the benefits to using BricsCAD, while saving your firm a lot of money on hardware upgrades and software licenses. You'll read about the advantages to switching to BricsCAD, how it is similar to AutoCAD, and about some of the issues on which to keep an eye.

We provide you with details on the differences and similarities in user interfaces, compatibility of DWG files, and even how to operate two CAD systems in the same design office.

At the end of this book, we provide you with useful appendices that exhaustively cross-reference command and variable names between the two CAD systems — along with shortcut keystrokes and mouse button actions.

Or perhaps you are simply wondering about the differences between market leader AutoCAD and aggressive up-and-comer BricsCAD. Whichever the case, this book is for you. Now in its 12th edition, the book is updated to include functions added to BricsCAD V20.

Welcome!

The Bricsys Benefit

Bricsys is a small operation compared to Autodesk. But dealing with a firm as expansive as Autodesk carries a with certain amount of risk, and it pays to be aware of what these risks could be.

THE AGONY OF AUTOCAD

Autodesk offers a rich variety of nearly two hundred software packages and bundles. AutoCAD itself comes in a dozen variations, with versions specific to architecture, civil engineering, and so on. The company prefers customers license bundles of a dozen or so programs, which it calls “Collections,” such as Product Design Collection. This much choice can become confusing for potential customers trying to determine which product or bundle is best suited to their design needs.

When you depend on the good will of a single, large software supplier, you face risk. Software crucial to the operation of your company might become a drag on profits to the large software provider, and so they might stop supporting it. Autodesk fine-tunes its products to maximize profits on behalf of its shareholders. As a result, the software you buy today may not be available tomorrow.

For example, Autodesk in years past moved customers from its FM:desktop facilities management software to another company; halted development of its Constructware construction management software; and orphaned users of other packages, such as Generic CADD (a low-cost CAD package), Actrix Technical (diagramming software), StudioDesk (architectural concept software), Mechanical Desktop (AutoCAD-based 3D mechanical design software), 123D.com (simple 3D modeling), and Impressions (post-design rendering software) — among others.

Being a large company, Autodesk needs to charge prices that tend to be high. The old \$4,200 price of its foundation drafting package, AutoCAD, is 4x to 10x more costly than many office productivity packages.

3ds Max	BIM 360 Plan	Helius PFA (US site)	PowerShape
A360 (US site)	BIM 360 Plan iPad app	HSMWorks	Product Design & Manufacturing Collection
Advance Steel (US site)	BIM 360 Team (renewal only)	Infrastructure Design Suite (renewal only) (US site)	Product Design Suite (renewal only) (US site)
Alias AutoStudio (formerly Alias Automotive)	Building Design Suite (renewal only)	Infrastructure Map Server (renewal only) (US site)	ReCap
Alias Concept	Buzzsaw (US site)	InfraWorks	ReCap Pro
Alias Design	CFD (Autodesk CFD) (US site)	InfraWorks iPad app	ReMake (discontinued) (US site)
Alias SpeedForm	Character Generator	Insight (US site)	Autodesk Rendering
Alias Surface	Civil 3D	Instructables	Revit
Architecture, Engineering & Construction Collection	Collaboration for Revit (renewal only)	Inventor	Revit Live
Arnold	Composite	Configurator 360 (US site)	Revit LT
ArtCAM (discontinued) (US site)	Constructware (renewal only) (US site)	Inventor CAM	Robot Structural Analysis Professional (US site)
AutoCAD	Creative Market	Inventor Engineer-to-Order (US site)	Screencast
AutoCAD Architecture (US site)	Design Review (US site)	Inventor LT	Shotgun (US site)
AutoCAD Design Suite (renewal only) (US site)	DWF Writer (US site)	Inventor Nastran (US site)	Showcase (US site)
AutoCAD Electrical	DWG TrueConvert (see DWG Viewers)	Inventor Nesting (US site)	Simulation Mechanical (US site)
AutoCAD for Mac	DWG TrueView	Inventor Professional	SketchBook for Enterprise
AutoCAD Inventor LT Suite	Dynamo Studio	Lustre	SketchBook Pro
AutoCAD LT	EAGLE	MatchMover	Smoke
AutoCAD LT for Mac	Entertainment Creation Suite (renewal only) (US site)	Maya	Stingray
AutoCAD Map 3D	Media & Entertainment Collection	Maya LT	Structural Analysis for Revit
AutoCAD Mechanical	Meshmixer	Media & Entertainment Collection	Structural Bridge Design (US site)
AutoCAD MEP	Moldflow Advisor (US site)	Moldflow Communicator (US site)	Tinkercad
AutoCAD mobile app (formerly AutoCAD 360)	Moldflow Inspector (US site)	Moldflow Insight (US site)	TruFiber (renewal only) (US site)
AutoCAD OEM (US site)	Moldflow Nesting (US site)	Motion FX	TruLaser (renewal only) (US site)
AutoCAD P&ID (US site)	MotionBuilder (US site)	MotionBuilder (US site)	TruNest (US site)
AutoCAD Plant 3D	Mudbox	MotionBuilder (US site)	TruPlan (renewal only) (US site)
AutoCAD Raster Design	Navisworks Freedom	MotionBuilder (US site)	Vault Basic (US site)
AutoCAD Revit LT Suite	Navisworks Manage	MotionBuilder (US site)	Vault Office (US site)
BIM 360 Design	Navisworks Simulate	MotionBuilder (US site)	Vault Professional (US site)
BIM 360 Docs	Forge	MotionBuilder (US site)	Vault Workgroup (US site)
BIM 360 Field	FormIt	MotionBuilder (US site)	Vehicle Tracking
BIM 360 Field iPad app	Fusion 360	MotionBuilder (US site)	VRED Design
BIM 360 Glue	Fusion Connect	MotionBuilder (US site)	VRED Presenter
BIM 360 Glue iPad app	Fusion Lifecycle	MotionBuilder (US site)	VRED Professional
BIM 360 Ops (formerly Building Ops) (US site)	Fusion Team	MotionBuilder (US site)	VRED Server
	Helius Composite	MotionBuilder (US site)	Within Medical (US site)

Autodesk's offerings of software at <http://www.autodesk.ca/en/products-standard> as of November, 2018

Subscriptions. Autodesk made annual subscriptions mandatory for AutoCAD after January 31, 2016, and so it no longer sells perpetual licences. This means you pay annually (or monthly) for the software; if you do not pay, the software stops working at the end of the term — full stop. If your firm cannot afford the subscription fee at renewal time — such as in the midst of a recession or due to a slowdown in orders — then your company’s future is at risk.

Autodesk has stated that it makes more from customers paying subscriptions than on perpetual licenses — which means that you might be paying Autodesk more to run CAD than you need to. Autodesk began by charging 1/3 of the software’s old perpetual license price as its annual subscription fee. Clearly you are, after three years, paying more. With many customers on subscription, Autodesk began increasing the subscription prices, with the occasional sale. The payments never stop — unless you switch to another CAD software supplier.

License Terms. Upon installing the software, Autodesk customers must agree to onerous terms dictated by Autodesk in its software license. Many customers don’t bother reading EULAs (end user license agreements) because the text is lengthy, and **SOME SECTIONS ARE MADE EVEN MORE DIFFICULT TO READ THROUGH THE USE OF UPPERCASE LETTERS.**

If you do read it, you may be shocked to learn that you are allowing Autodesk to send agents into your private home and business to search for unauthorized copies. Autodesk can require you to have your computers audited remotely, to see if you are cheating — even when it has no evidence that you are.

Worse, the EULA makes it illegal for customers to travel outside their country with Autodesk software residing on their computers. Before getting on that airplane, you are required to erase AutoCAD from your computer. Autodesk does this to protect regional sales, but it is a shortsighted move that blocks its customers from taking part in the reality of today’s globalized business.

THE BUSINESS OF BRICSYS

In contrast to Autodesk, Bricsys makes choice easy by offering just one software package in three levels of capabilities, along with three vertical add-ons. Compare the list below with the Autodesk list on the facing page:

BricsCAD Shape	Free 3D modeling version of BricsCAD for early design work
BricsCAD Classic	Budget-priced 2D CAD software with limited 3D modeling
BricsCAD Pro	All of Classic, plus rendering and all APIs
BricsCAD Platinum	All of Pro, plus access to add-ons listed below
BricsCAD Ultimate	Platinum and includes all of the add-ons listed below
.....	
BIM	Building information modeling and IFC connection
Communicator add-on	Standard and proprietary MCAD file format translation
Mechanical	Mechanical design, sheet metal design, and CAM system output

Communicator requires a Pro or Platinum license; BIM, Mechanical, and Ultimate include the Platinum license.

Here is a comparison of some of the major capabilities of each edition. For a more detailed comparison, please refer to https://www.bricsys.com/en_INTL/bricscad/compare/.

Function	BricsCAD Classic	BricsCAD Pro	BricsCAD Platinum
2D Design and Editing	Included	Included	Included
Printing, Exporting, Importing	Included	Included	Included
Constraints	...	2D	2D and 3D
ACIS 3D Solids Modeling	Viewing	Modeling, editing, viewing	Modeling, editing, viewing
Direct 3D Editing	Viewing	Modeling, editing, viewing	Modeling, editing, viewing
History-based 3D Modeling	Viewing	Modeling, editing, viewing	Modeling, editing, viewing
Design Intent	Modeling and editing
3D Assemblies and BOMs	Viewing	Viewing	Modeling, editing, viewing
Generated Drawings	Viewing	Included	Included
Surface 3D Modeling	Viewing	Viewing	Modeling, editing, viewing
Deformable Modeling	Viewing	Viewing	Modeling, editing, viewing
Kinematic Analysis	Viewing	Viewing	Modeling, editing, viewing
BOM	Viewing	Viewing	Modeling, editing, viewing
GIS	Included	Included	Included
Rendering	...	Included	Included
Customization	Included	Included	Included
Third-party Applications	...	Accessible	Accessible
Programming	LISP, TX	LISP, TX, BRX, VBA, .Net	LISP, TX, BRX, VBA, .Net

BricsCAD Ultimate is the full-featured version of BricsCAD: it has everything. The Pro version is almost identical to the Platinum version, leaving out only the parametric-based 3D modeling and 3D constraints. The Classic version costs the least because it leaves out features for which Bricsys pays royalties, and so it excludes ACIS modeling and editing, and VBA, TRX, and .Net programming.

BricsCAD uses the highly compatible Drawing libraries from Open Design Alliance to read and write DWG and other files.

A Substitute for AutoCAD and AutoCAD LT

BricsCAD is compelling alternative to AutoCAD LT, as LT isn't a networkable product, and is severely limited in customization. Companies settle for AutoCAD LT because they want CAD for everyone but don't have a budget for full AutoCAD. They end up with lots of LT licenses with a few network licenses of AutoCAD to run LISP/VBA. BricsCAD Pro can replace both.

In summary, Bricsys has a simple-to-understand product line, doesn't charge high prices, and doesn't impose mandatory subscriptions. The terms in its license allow you to use the software in any country, and Bricsys does not threaten to send agents into your home.

24/7 Project Management

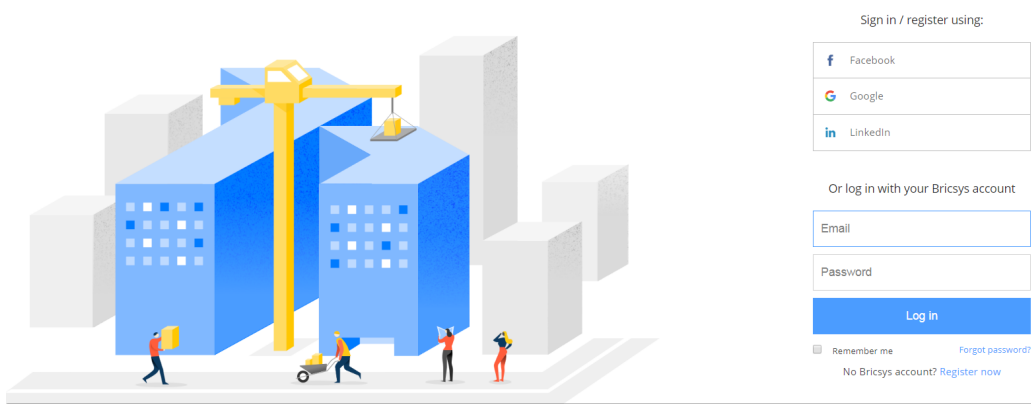

The home screen for 24/7

For managing drawing projects, Bricsys recommends 24/7 (previously known as Chapoo). This browser-based communication, collaboration, and project management system does not require BricsCAD, so it works with any office system. It is, nevertheless, integrated into BricsCAD through options in the File menu.

24/7 project management offers your firm the following benefits:

- ▶ **Speed.** View multi-megabyte drawings in seconds, zooming in on details and examining annotations with fly-over text that lists time stamp and author. 24/7 supports 70+ file formats, like Excel, Visio, MS Project, and AutoCAD.
- ▶ **Upload Files.** Drag and drop files into the upload area of 24/7.
- ▶ **Share Files and Folders.** Files can be shared through email, Facebook, or Twitter; folders are shared with other 24/7 users only. You have 1GB of online storage space to start with.
- ▶ **Create Annotations.** Drag a rectangle over the text or image to highlight, and then enter mark-ups in a few words or attach multiple text pages to the annotation. When you notify friends about it, 24/7 emails a link with direct access to the file with the annotations.
- ▶ **Manage Compliance.** Follow a continuous audit trail of the entire project process. 24/7 automatically maintains log files of project activities and participants.
- ▶ **Single Access Point.** You have a repository of all actions, documents, meetings, and participants in a single location.
- ▶ **No Software to Install.** Work with an ASP (application service provider) system. The software runs on central servers with guaranteed access 24/7; you only need an Internet connection and a supported Web browser.

There are two versions, the for-free 24/7 Free and the fee-based 24/7. Unlimited access is available to an unlimited number of participants through a yearly flat fee based on industry type and company size. Portable versions of the service are available for Android and Apple tablets. For more information, please visit <https://www.bricsys.com/en-intl/247/>.

Bricsys Shape: Early-Phase Design Software (Free)

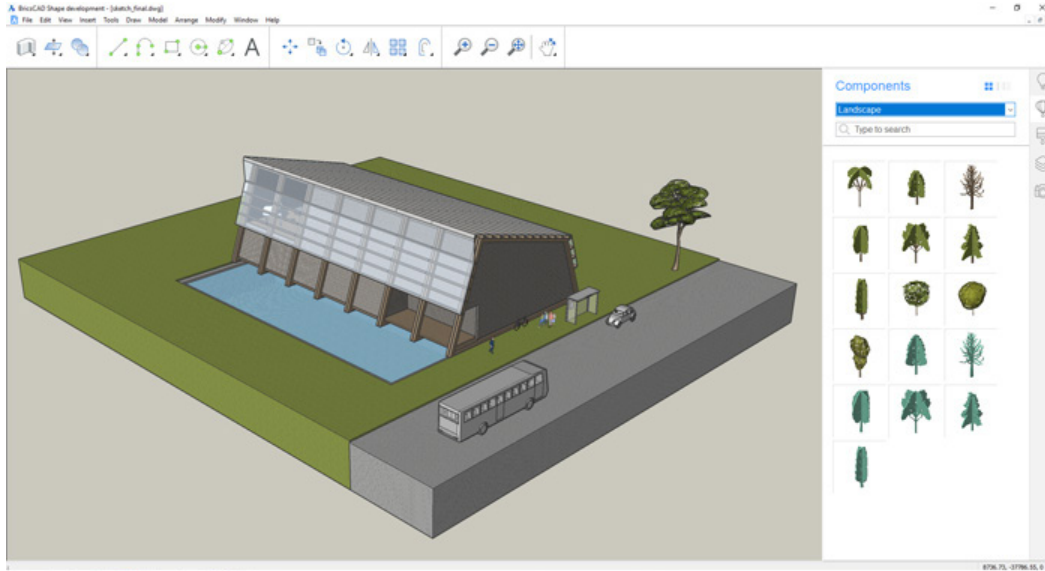

BricsCAD Shape adding blocks to a 3D model

To help customers at the early design stage, Bricsys gives you BricsCAD Shape for free. This 3D-only modeler applies materials, inserts blocks, and is 100% compatible with BricsCAD. The company sees it as a replacement to SketchUp. (Autodesk has no software like Shape.)

(new in V20) Shape is included with your BricsCAD installation. To start it, click the Shape button in the Launch dialog box, which appears when BricsCAD first starts. See <https://www.bricsys.com/en-intl/shape/>.

BricsCAD is Not IntelliCAD

Readers familiar with BricsCAD may know that many years ago it was based on IntelliCAD, an AutoCAD workalike programmed by the IntelliCAD Technical Consortium. *Was* is the important word here. The executives of Bricsys decided they would rather develop BricsCAD on their own, faster. During BricsCAD V8 and V9, Bricsys concentrated on replacing all of the ITC's programming code with its own new code. As of BricsCAD V10, the software is 100%-Bricsys.

With Bricsys' purchase in 2010 of the programming division of Russian software company LEDAS, functions grew dramatically with V12 and following. Today we see BricsCAD equipped with 3D constraints, sheet metal and BIM modeling, 3D surface modeling, and many other functions not found in IntelliCAD.

The BricsCAD Advantage

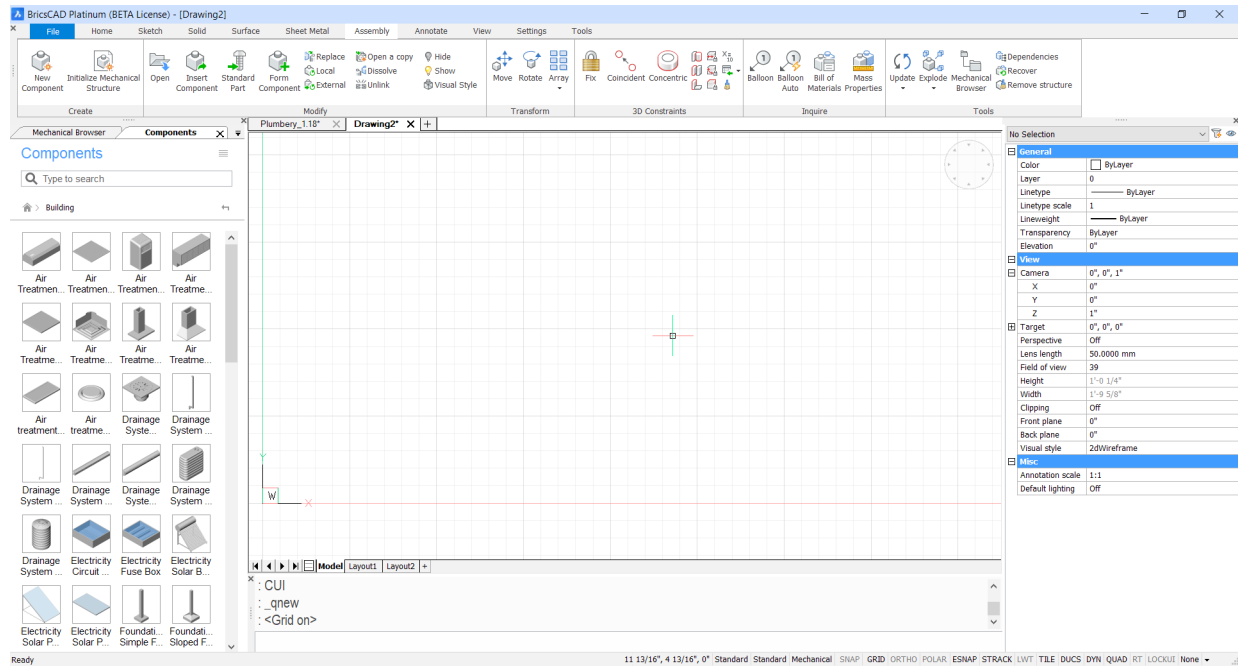

BricsCAD V20 Mechanical

When you consider BricsCAD, consider it for its own benefits, which are significant. These include a similar user interface, additional commands and variables that AutoCAD lacks, support for operating systems in addition to Windows, built-in direct 3D modeling and editing, 3D constraints, a no-charge developer network — and lower pricing.

MANY FILE FORMATS VS. UNIVERSAL DWG FORMAT

AutoCAD uses DWG as its file format for saving and sharing drawings, as does BricsCAD. But when it comes to Autodesk's significant verticals, the sharing ends there. Each has its own format, which can be a source of frustration for Autodesk customers. An AutoCAD user cannot, for instance, cleanly read in a Revit drawing, and cannot read FormIt files at all.

By contrast, Bricsys uses the universal DWG format for all of its vertical, discipline-specific software:

Vertical	Autodesk		Bricsys	
	Program	File Format	Program	File Format
General CAD	AutoCAD	DWG	BricsCAD	DWG
Building Design	Revit	RVT	BricsCAD BIM	DWG
	FormIt	AXM	Sketch	DWG
Mechanical Design	Inventor	IPT, etc	BricsCAD Mechanical	DWG
	Fusion	F3D		
	Fusion360 *			

*) Fusion 360 stores drawings in Autodesk's cloud, and so it does not have an easily accessible file format

SPEED

As CAD programs take on more functions, some of them operate more slowly than before, while others incorporate speed enhancements. Here are the results of several speed tests made by independent bloggers:

Function	AutoCAD	BricsCAD	BricsCAD Advantage
Open 500 DWG files	18 min 39 sec	6 min 51 sec	2.7x faster
Advanced LISP routine	49 min 30 sec	17 min 10 sec	2.8x quicker
Installation time	17 min 18 sec	0 min 40 sec	25.9x schneller

In these tests, BricsCAD is significantly faster than AutoCAD.

NEAR-IDENTICAL USER INTERFACE

When you launch BricsCAD for the first time, you will notice that it looks very much like AutoCAD — complete with ribbons and/or toolbars, menu bar, command prompt, and palettes.

As illustrated amply by the appendices at the back of this book, BricsCAD uses the same names for many AutoCAD commands and system variables. It also uses the same keystroke shortcuts. Commands that are missing from BricsCAD are probably ones you weren't using anyhow.

The user interface of BricsCAD is available in English and a dozen other languages. It can be customized. Chapter 2 describes the user interface in detail.

Extra Commands and System Variables

AutoCAD boasts more than 1,700 commands and variables; BricsCAD has 2,185 commands and variables. BricsCAD mimics most of them, and then has additional useful commands and variables that are not found in AutoCAD.

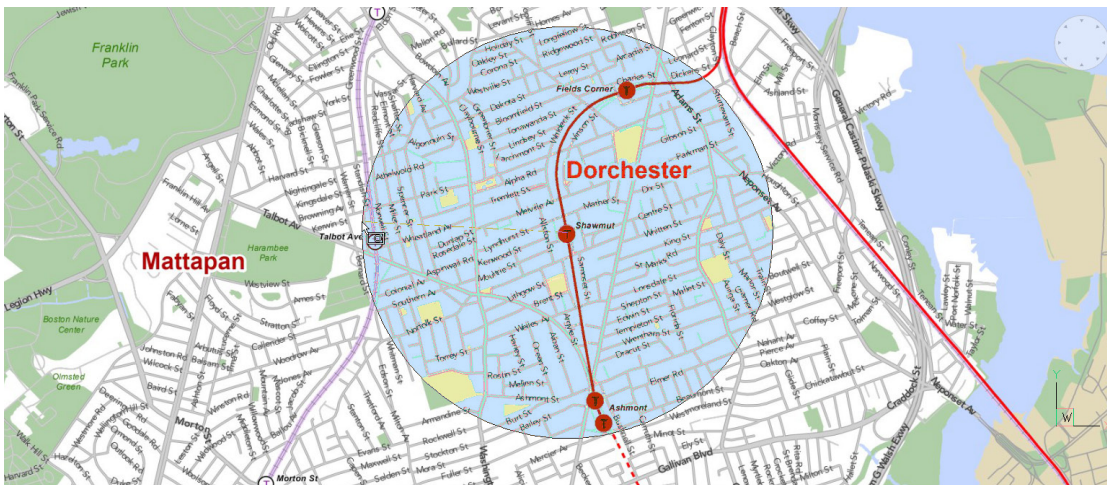

BricsCAD performing a circular selection set with the blue-filled area (map courtesy of City of Boston)



More Ways to Select. BricsCAD offers more ways to select objects than does AutoCAD, such as by circular and external selection sets.

3D Modeling Advanced. BricsCAD creates and edits 3D models and sheet metal designs with 3D constraints (not available in AutoCAD at all).

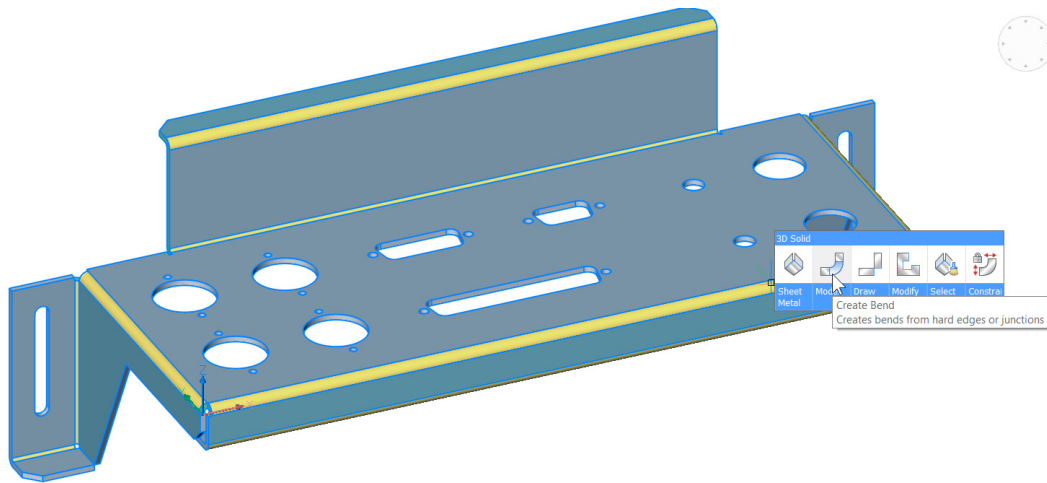

BricsCAD using color coding to indicate sheet metal elements

Object Snaps as Commands. In BricsCAD, for example, all entity (object) snaps are available as command names. This lets you directly enter them like a command, such as **Intersection** and **Midpoint**.

Extended Entity Manipulation. BricsCAD uses commands to manipulate extended entity data, something available in AutoCAD only through programming.

Settings and Variables. AutoCAD stores user settings in a number of locations scattered throughout the program. Some of them can be difficult to access.

In contrast, BricsCAD summarizes all variables and options in a single dialog box accessed by the **Settings** command. As a bonus, Settings can show you only those variables that have changed from their default values.

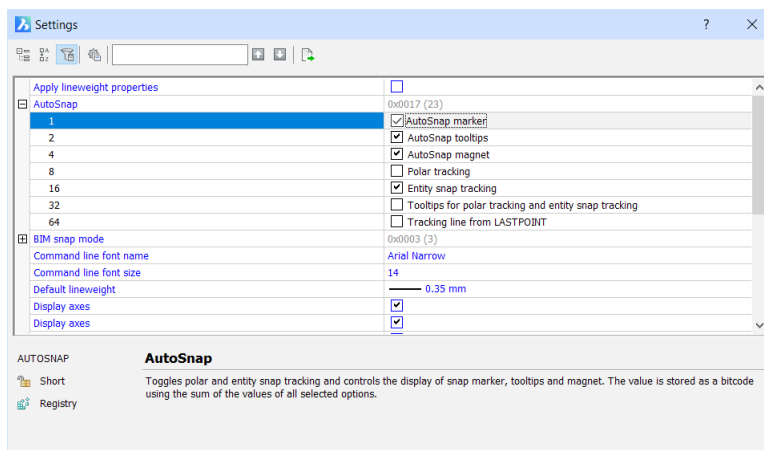

Settings dialog box showing those settings whose values changed from the defaults

Bonus Settings. BricsCAD offers you extra control of the program through variables known as “preferences,” such as **BkgColor** for specifying the background color of the drawing area and **CmdLineFontName** for setting the name of the font used by the command bar.

Quad Interface. Unique to BricsCAD is the Quad cursor. When you hover over a feature, such as a 2D object or a 3D face, it instantly reports information about. (You can customize the information to be reported.)

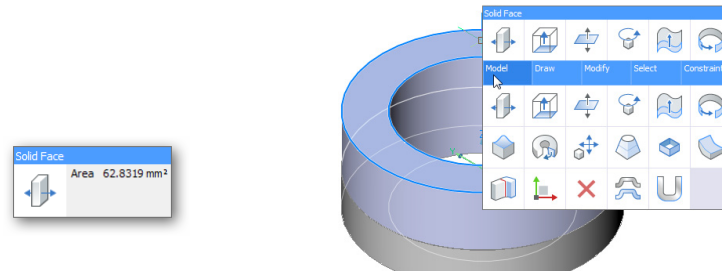

Quad cursor provides fast access to entity data (left) and context-sensitive commands (right)

Move the cursor downwards, and the Quad displays the commands most likely needed to manipulate the feature.

When no objects are selected, right-click to display the Quad cursor with drawing commands. You can customize the content of the Quad cursor to your liking.

3D Direct Modeling and Constraints

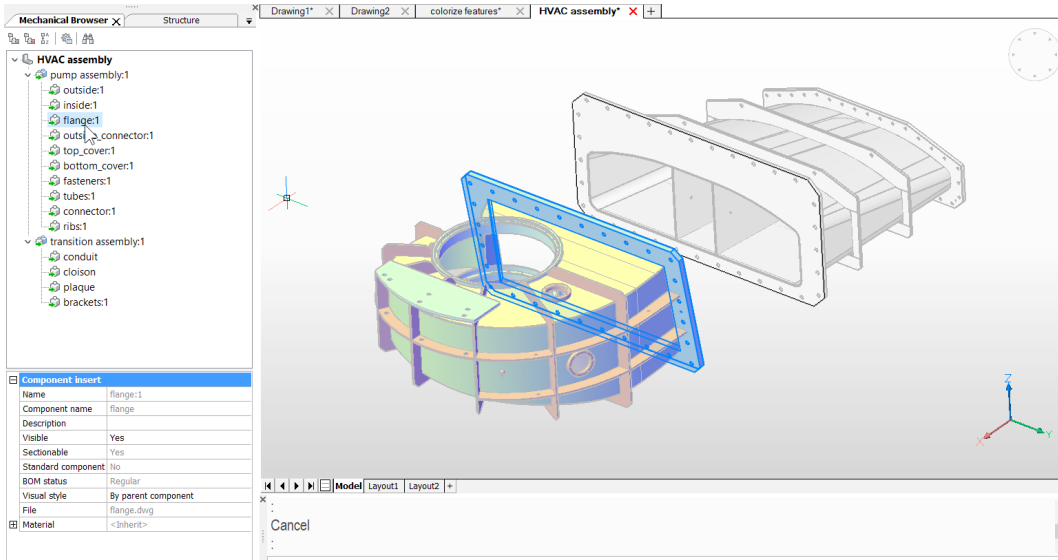

Assembly of sheet metal parts in BricsCAD

When it comes to 3D design, BricsCAD is dramatically ahead of AutoCAD. The Platinum edition applies 3D constraints and infers design intent — in addition to placing 2D dimensional and geometric constraints. AutoCAD does not have 3D constraints or design intent. (The Pro edition of BricsCAD has 2D constraints.)



BricsCAD offering 3D constraints and entity snaps

To model assemblies of complex products, BricsCAD employs *.dwg* files of mechanical components and orders them in hierarchical structures, even reading assembly structures from other MCAD systems, like Solidworks and Autodesk Inventor. Kinematic analysis of moving and rotating parts reviews motions forwards and backwards in real time. Sheet metal and BIM (building information modeling) design are optional add-on modules. None of these are in AutoCAD or operate with *.dwg* files.

Direct modeling and editing lets you directly interact with 3D models. See chapter 6 for more on this. While this is possible in AutoCAD, Autodesk tells its users to use their stand-alone Fusion 360 software.

Artificial Intelligence

The idea of computers doing thinking for us has been around since the 1950s. We call this artificial intelligence (AI). There are varieties of AI ranging from the fully autonomous robots of science fiction to software routines that do drudge work for us. Both Autodesk and Bricsys speak of AI (and its cousin, machine learning);y Bricsys has implemented a form of it in BricsCAD.

Two commands that perform AI-like drudge work in BricsCAD are Bimify and Blockify.

Bimify looks for BIM-like solids in 3D models, such as slabs (floors) and walls, and then tags them with BIM data. This action turns imported models from other CAD programs into BIM models much more quickly than a human can. Bimfy is available in the BIM and Ultimate editions of BricsCAD.





Blockify scans a drawing for two or more elements that are identical and then offers to turn them into blocks. When entities are replaced by blocks, drawings become smaller and more efficient.

(NEW IN V20) Blockify is available in all editions of BricsCAD. It now handles geometry inside existing block definitions, tolerances, arrays, and wipeouts.

APIs AND CUSTOMIZATION

Bricsys is making it easier for third-party developers to adapt AutoCAD add-ons to BricsCAD — just as Bricsys works to make it easy for AutoCAD users to learn BricsCAD through this book. For programmers, this is done with *APIs*, short for “application programming interfaces,” and BricsCAD supports almost the same list of APIs as does AutoCAD.

Get started as developer

-  Register as developer
-  Explore the API
-  Port your application to BricsCAD
-  Add your app to the Application store
-  We promote your application

Supported APIs

With BricsCAD, you can run many programs originally created for use with AutoCAD without modification on BricsCAD. BricsCAD supports the AutoCAD dialog control language (DCL). You can use all DCL files unmodified within BricsCAD. To write applications in C or C++, BricsCAD offers BRX, a C/C++ language interface, code-compatible with the AutoCAD Runtime eXtension (ARX) interface in AutoCAD.

BricsCAD offers several APIs

- > LISP (LIST Processing)
- > DCL (Dialog Control Language)
- > DIESEL (Direct Interpretively Evaluated String Expression Language)
- > COM (Component Object Model)
- > VBA Visual Basic for Applications)
- > BRX (BricsCAD Runtime eXtension)
- > TX (Teigha eXtension)
- > .NET

AutoCAD API	Equivalent in BricsCAD	Notes
Action Recorder (*)	Scripts, SCR	AutoCAD's Action Recorder scripts cannot be edited; scripts recorded by BricsCAD can be edited
ActiveX	ActiveX	In-place editing; not available in BricsCAD for Linux or Mac
ADS	SDS	ADS code ported from AutoCAD requires just a recompile using BRX headers; ADS/SDS are deprecated by Autodesk and Bricsys.
ARX	BRX or TX	Ported ARX code requires just a recompile using new BRX headers; when used with TX (ex-DRX), ported ARX code must be rewritten
AutoLISP	LISP	Ported AutoLISP code runs as-is in BricsCAD; no changes needed, includes support for Vl, Vlr, Vla, and Vlx functions and encryption
COM	COM	Ported AutoCAD COM code runs as-is in BricsCAD; not available in BricsCAD for Linux or Mac
CUI	CUI	Ported AutoCAD CUI files made need adjusting for BricsCAD
Diesel	Diesel	Ported Diesel code runs as-is in BricsCAD; no changes needed
DCL	DCL	Ported DCL code runs as-is in BricsCAD; no changes needed
.Net	Teigha.NET	BricsCAD provides Teigha.NET and extra BRX-managed wrappers; not available in BricsCAD for Linux, Mac, or Windows Classic versions
...	TX	Teigha eXtensions (formerly DRX) from Open Design Alliance; not available in AutoCAD.
VBA	VBA	Current AutoCAD VBA code runs as-is in BricsCAD for Windows; not available in BricsCAD Linux, Mac, or Windows Classic versions
VSTA	...	VSTA is unavailable in BricsCAD

Generally, BricsCAD provides a nearly identical subset of equivalent function names. In the case of non-compiled code, such as LISP and DCL, you just drop it into the BricsCAD environment. With compiled code, you recompile it using headers provided by Bricsys to registered developers. See https://www.bricsys.com/en_INTL/applications/developers/.

Examples of Add-ons

Independent programmers have written dozens of add-ons that tailor BricsCAD for specific applications in the areas of AEC, civil, data exchange, electrical, GIS, survey and mapping, general tools, HVAC, mechanical, packaging, rendering, and structural design. Here are a few examples:

Civil Site Design from Civil Survey Solutions designs roads, drainage, and siteworks dynamically. It rapidly create highway, subdivision, and reconstruction road designs by combining template and string-based design inside BricsCAD. <https://www.civilsitedesign.com.au/>

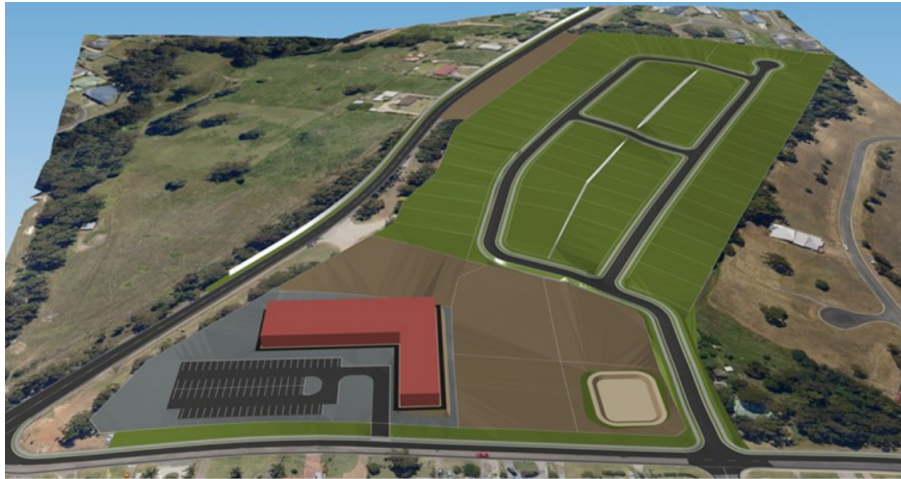

Rendering of siteworks

PON CAD Scaffolding Design from MEC CAD di Luciano Donno manages any type of scaffolding, stages, stands and covers. It generates BOMs, quotations, and component listings. <http://www.meccad.net/>



Scaffolding at a construction site

GlobalCAD Landscape from GlobalCAD Consultants Ltd carries out landscape design, land planning, and irrigation inside BricsCAD. It includes 2D and 3D design libraries, scheduling and BOMs, and handles survey data and terrain modeling. <https://www.globalcad.com/>

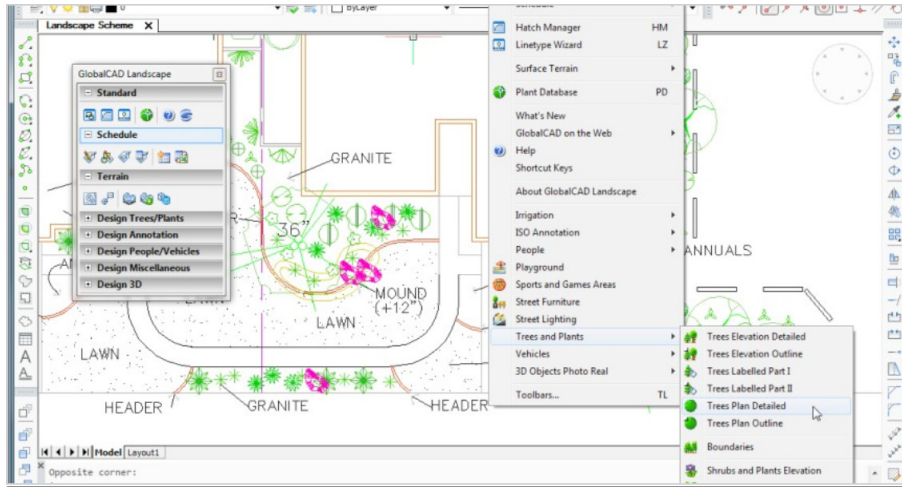

Range of tasks performed by DS Tools

At time of writing, over 300 third-party applications are available for BricsCAD. For the complete list, visit the company's Applications Store at <https://www.bricsys.com/applications/>.

No-charge Developer Network

Bricsys does not charge third-party developers a fee; Autodesk charges an annual fee of \$1,400 or more. You do not pay Bricsys a fee to join, you do not pay an annual membership, you do not pay for support, and you do not pay royalties on shipping products.

The reason support is free is because Bricsys feels that to become a successful CAD company it needs to encourage the development of many, *many* add-on applications — currently 1,500, a number that includes ones written privately. The company feels so strongly about third-party development that it has halted development of its own add-ons, except for a few that benefit many users.

Bricsys now concentrates on two tasks:

- ▶ Improving BricsCAD
- ▶ Adding to APIs

End users also benefit from APIs. (The application programming interface is the software link between CAD software and programming languages/compilers.) When a third-party developer requests an addition to the API, the added code becomes a new feature in BricsCAD that end users can employ.

LOWER PURCHASE AND MAINTENANCE PRICES

Perhaps the most dramatic difference from AutoCAD is that the most expensive version of BricsCAD is **2.5x cheaper** than AutoCAD. To put the math another way, your office can be outfitted with four seats of BricsCAD Platinum in place of one seat of AutoCAD — and have money left over to buy another computer.

BricsCAD has a single upgrade price and a single maintenance price for all editions.

List Price ¹	AutoCAD	AutoCAD LT	BricsCAD Platinum	BricsCAD Pro	BricsCAD Classic
Perpetual License ²	“\$4,410”	“\$1,140”	\$1,560	\$1,105	\$825
Subscription	\$1,575/year	\$ 390/year	\$ 588/year	\$ 410/year	\$312/year

¹ US\$ pricing for single-user license; price may be different in other currencies. Lower pricing usually available for multi-seat purchases and networked versions; student-use licences are free. Prices as at 18 November 2018.

² Autodesk “perpetual” licence price no longer available, and is shown for illustrative purposes based on 3x subscription cost.

³ Annual maintenance requires a one-time perpetual license purchase; includes advanced support and all upgrades.

In addition to the add-on provided by third party developers, Bricsys provides three add-ons for sophisticated modeling:

Add-on	Purpose	Price ¹	Autodesk Equivalent	Autodesk Price ²
BIM ³	Building information modeling	\$2,405 \$ 910/yr	Revit	\$ n/a \$2,250 per year
Communicator ⁴	File translation	\$715 \$286/yr	Included with AutoCAD	...
Mechanical ³	3D Mechanical design	\$2,275 \$ 862/yr	Inventor	\$ n/a \$1,935 / year

¹ US\$ pricing for single-user license; price may be different in other currencies. Lower pricing usually available for multi-seat purchases and networked versions; student-use licences are free. Prices as at 6 November 2017.

² Autodesk a subscription pricing; must be paid each year for the software to continue operating.

³ Requires a BricsCAD Platinum license

⁴ Requires a BricsCCAD Pro or Platinum license

In 2016, Autodesk eliminated nearly all perpetual license sales. This means that annual subscription payments are compulsory when purchasing new software from Autodesk. After three years of subscription payments, you are paying Autodesk more than you would have with a single perpetual license payment. See <http://www.autodesk.com/store> for pricing details on all Autodesk products.

In contrast, BricsCAD saves you money through lower pricing to start off with, and a maintenance fee that’s lower than Autodesk’s subscription cost. Bricsys allows you to chose whether to upgrade (or not) or to subscribe (or not); Autodesk does not. You save even more money, because BricsCAD has less stringent hardware requirements, and allows you to run on a free operating system, Linux (not available from Autodesk). See Chapter 5 for running CAD on Linux.

See <https://www.bricsys.com/estore/> for pricing details on all Bricsys products.

Keep Your BricsCAD

If you like your old BricsCAD, you can keep your old BricsCAD. When new releases come out, Bricsys does not force you to give up your old software. When you get a license number for V20, it powers BricsCAD as far back as V14.

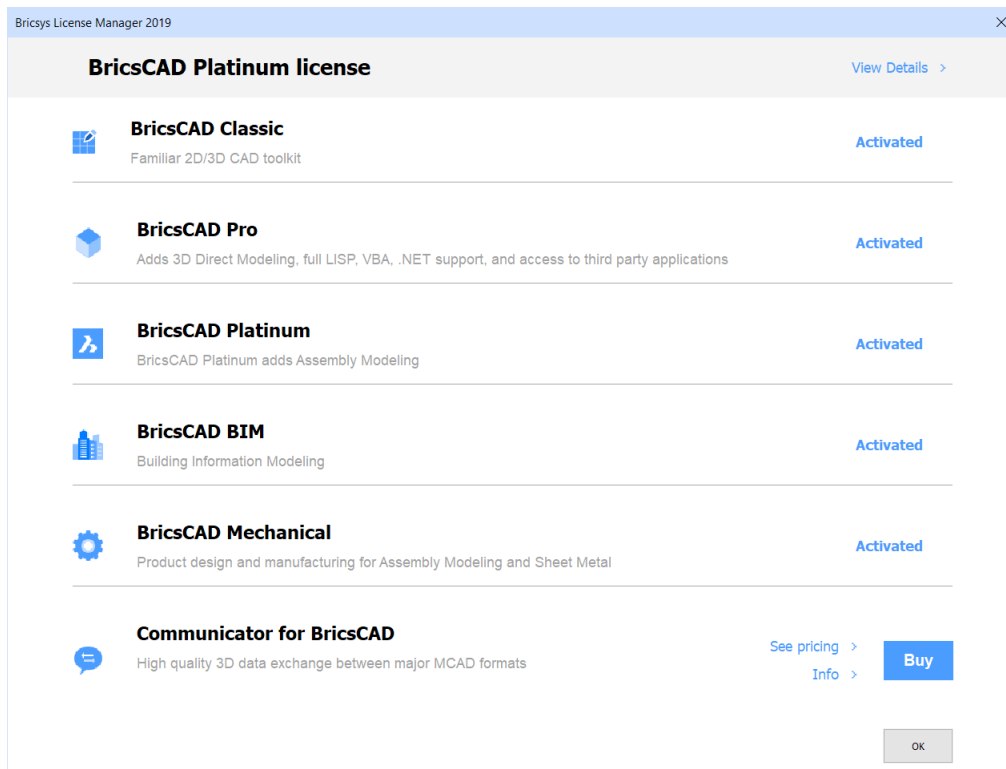

Licensing dialog box for BricsCAD

BricsCAD licenses can be moved between computers, just like AutoCAD. This lets you install the software as many times as you need, then just deactivate the current one to activate BricsCAD on another computer.

It Makes More than Cents

You could ask, “Are AutoCAD’s additional functions worth the \$3,300 difference in price?” For some users, a high price makes sense to them. But for others, the difference means they can get more software. For example, you could model a 3D boat hull in Rhino and then add 2D details and annotations with BricsCAD.

You get 3D mesh modeling with Rhino at \$995, add a Rhino-BricsCAD file converter (\$95) — and still be two thousand dollars ahead. Rhino is available from Robert McNeel & Associates at <http://www.rhino3d.com/download>; the 3DM converter is sold at the Bricsys eStore.

WHAT'S MISSING FROM BRICSCAD?

BricsCAD doesn't have every feature found in AutoCAD. As I update this ebook each year, the list becomes shorter with each release of BricsCAD. Here it is as of V20, with those added to BricsCAD V20 shown ~~crossed through~~:

- ▶ AutoPublish
- ▶ CAD standards
- ▶ Markups
- ▶ Quick view thumbnails
- ▶ 3D mesh modeling

At first glance, there are AutoCAD features that appear to be missing from BricsCAD, but a second glance shows that BricsCAD has near-equivalents operating under other names. Here are some examples:

AutoCAD Feature	BricsCAD Equivalent	Command Name(s) in BricsCAD
Action Recorder	Script recorder	RecScript, StopScript
DesignCenter	ContentBrowser	ContentBrowserOpen
Dynamic blocks	Parametric blocks	BEdit
QLeader	Leaders	DimLeader
Real-time dimensioning	Dimensioning with Quad and Dim	Dim
ViewCube	LookFrom widget	LookFrom
VSTA	VBA and .Net	VBA, AppLoad

Chapter 3 provides complete details of which AutoCAD entities work in BricsCAD.

What's Missing from AutoCAD

BricsCAD Platinum, Mechanical, or BIM offer these 2D and 3D functions that are not found in AutoCAD 2019, which costs 2.5x as much.

- ▶ Editing 3D models directly
- ▶ 3D model comparison
- ▶ Parametric 3D part library
- ▶ Placing 3D constraints
- ▶ Assembling parts into models, animating assemblies
- ▶ Parametric equations for arrays, animating parametrics
- ▶ Inferring design intent
- ▶ Block-ifying drawings to convert common entities into blocks
- ▶ Terrain modeling
- ▶ Analyzing kinematics
- ▶ Designing sheet metal
- ▶ Designing BIM
- ▶ Propagate details onto solids, optionally on a grid

- Quickdraw of buildings, walls, and levels
- Panelize surfaces
- Editing interactively with the Quad cursor
- Entering object snaps as command names
- Making circular, external, and other types of selection sets
- Manipulating extended entity data easily
- Circular grid and variable-spaced grid
- Command-less nearest distance measurement
- Accessing *all* system variables and options through a single dialog box
- Offering useful additional variables, such as BkgColor (specifies drawing area background color) and CmdLineFontName (sets the font for command bar text)
- Customizable clean screen display
- Layout manager
- Browser panel for showing all parts of drawings
- DGN import and FBX import

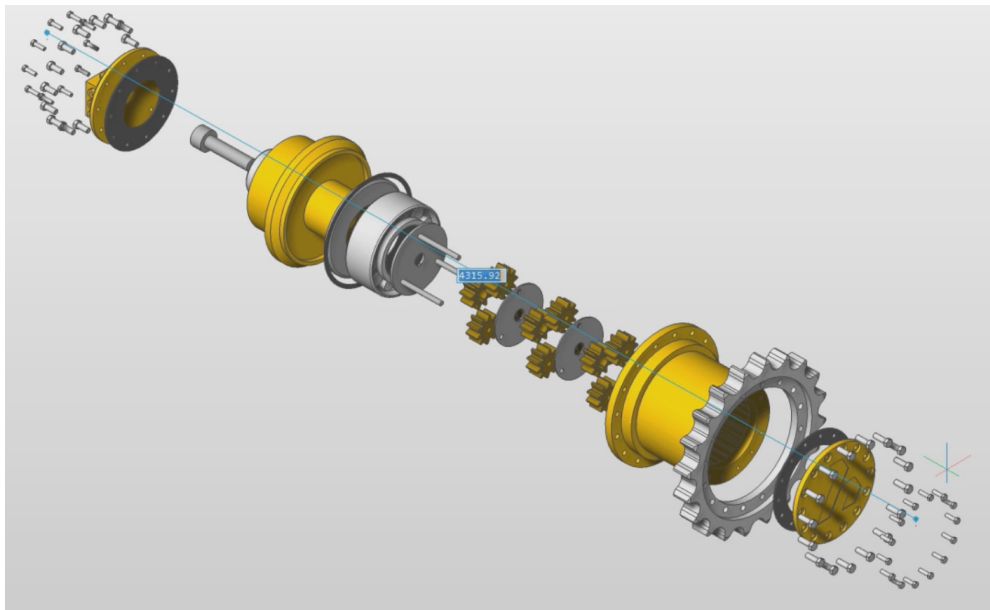

Exploding an assembly in BricsCAD Mechanical

System Requirements

Your accounting department will love that BricsCAD does not require new, expensive hardware. Your IT department will love that BricsCAD doesn't need the latest operating system. The savings to both are significant:

- ▶ Design firms run BricsCAD on computers they already have.
Benefit: This extends their investment in hardware, and manages costs to when they want to upgrade.
- ▶ BricsCAD uses less RAM and requires less CPU speed than AutoCAD.
Benefit: More memory space and CPU power is available for the software.

RECOMMENDED HARDWARE

Autodesk and Bricsys provides recommendations for the computer hardware specifications. BricsCAD runs well on older computers. AutoCAD for Mac will not run on unsupported Apple computers; BricsCAD works well with older Macs.

Here are the hardware specifications recommended for 64-bit computers systems. The hardware for Windows is the same for Linux.

Hardware	AutoCAD 2019	BricsCAD V20
CPU MacOS	1GHz 2GHz or faster Apple Mac Pro 4.1 or later MacBook Pro 5.1 or later iMac 8.1 or later Mac mini 3.1 or later MacBook Air 2.1 or later MacBook 5.1 or later	1GHz or faster CPU Any recent Mac
Minimum RAM MacOS	4GB 3GB	256MB, plus RAM required by OS
Recommended RAM MacOS	8GB or more 4GB	1GB or more
Hard Disk Space MacOS	4GB for installation 3GB for installation	250MB for program files + 1GB free space
Monitor Resolution MacOS	1024x768 minimum 1600 x 1050 recommended 1280x800 minimum 2880x1800 recommended	1024x768 with true color (minimum) 1024x768 with true color minimum
Graphics Board MacOS	DirectX 9 or 11 128MB (minimum) workstation-class Pixel Shader 3.0 or greater for 3D Direct3D for 3D For supported brands, see http://usa.autodesk.com/adsk/servlet/syscert?siteID=123112&id=18844534	Any XGA or better graphics board, such as from Intel, nVidia, and AMD Uses Redway3D for rendering
Pointing Device MacOS	Mouse Apple or Microsoft mouse or trackpad	Mouse Mouse or trackpad

ABOUT BRICSCAD NETWORK LICENSES

by Jason Bourhill

Once your firm has more than ten seats of BricsCAD, you should consider a bulk license for convenience and possible cost savings. The Bricsys bulk license system carries out unattended installs, configurations, and uninstalls of BricsCAD by the IT manager, as well as providing flexibility to end users. Bricsys offers two forms of bulk license, volume and network. Autodesk does not offer such licensing for AutoCAD LT.

VOLUME LICENSES

Volume licenses are essentially the same as stand-alone licenses, but require only a single authentication key to activate BricsCAD on multiple machines. This greatly simplifies license management.

Volume licenses suit organizations that have several staff requiring continuous access to BricsCAD. The cost is the same as a stand-alone 'All-In' license.

NETWORK LICENSES

Network licensing allows you to share BricsCAD licenses amongst multiple users on your network. Management is simple, and you can make BricsCAD available to as many users as you like. Network users can also book out a license, allowing for continued use away from the office.

Network licenses suit organizations that have a number of casual BricsCAD users. Cost is slightly more expensive than a stand-alone 'All-In' arrangement, but ongoing costs can be significantly less.

TIP The network license isn't limited to large organizations. A small company with a single network license can find it very flexible.

SUPPORT FOR NETWORKS AND LICENSES

You can download the Reprise License Manager used by BricsCAD from <https://www.bricsys.com/bricscad/tools/Bricsys-NetworkLicenseManager.msi>. For detailed information on the license manager software, download the PDF manual from the Reprise site http://www.reprisesoftware.com/RLM_License_Administration.pdf (PDF file). License administrator and user FAQs from Reprise Software can be read at <http://www.reprisesoftware.com/publisher/license-management-faq.php>.

When setting up the network, follow the advice of BricsCAD's online help at <https://help.bricsys.com/hc/en-us/articles/360006428594-Network-license-server>. In addition, the Bricsys Help Center covers typical network installation issues and error codes at <https://help.bricsys.com/hc/en-us/articles/360006531393-Advanced-configuration>.

Information on how to use the Bricsys network license on a server computer (for Linux and Windows only): <https://help.bricsys.com/hc/en-us/articles/360006530593-Windows-network-license-server-setup>. Large organizations may want to automate deployment through silent installation (Windows only): <https://help.bricsys.com/hc/en-us/articles/360006482194-Silent-Installation-Windows-only->.

See Appendix D for information on setting up network license servers for BricsCAD.

SUPPORT FOR MULTIPLE OPERATING SYSTEMS

Bricsys had the foresight to write the BricsCAD code so that it would independent of the operating system. And so the company can offer it in versions that run natively on Windows, Linux, and MacOS.

AutoCAD does runs on Windows and MacOS, but the MacOS version is handicapped. It leaves out roughly a third of the functions you get in the Windows version. Autodesk offers its list of functions missing from MacOS at <http://www.autodesk.com/products/autocad/compare/compare-platforms>. Yet Autodesk charges as much for the MacOS version as the Windows one.

Autodesk offers no Linux version, but has a reduced-function mobile version of AutoCAD that runs on Android, iOS, and in Web browsers. Bricsys does not.

BricsCAD, by contrast, offers almost all the same functions in all three OS versions, as shown by the comparison chart at <https://www.bricsys.com/en-intl/bricscad/compare/>. Those missing are specific to Windows, such as OLE functions.

Supported Operating Systems

Bricsys supports BricsCAD running on several dialects of Linux, as well as on MacOS (the new name for MacOS), and older releases of the Windows operating system.

Autodesk has not announced a Linux version, and no longer supports Windows Vista. While Autodesk has a version of AutoCAD for the Mac, it is missing numerous commands and most APIs.

Here is the list of operating system on which both CAD systems can run:

AutoCAD	BricsCAD
...	Windows Vista
Windows 7 SP1	Windows 7
Windows 8.1	Windows 8 or 8.1
Windows 10	Windows 10
MacOS v10.11 or later	MacOS v10.9 or higher
...	Ubuntu LTS Linux
...	Fedora Linux
...	OpenSuse Linux
...	Linux other distributions

The Windows versions of AutoCAD require Internet Explorer for functions such as help; BricsCAD works with any Web browser.

For more information on that operating systems on which BricsCAD runs, see http://bricsys.com/en_INTL/support/#30a=65

Information about AutoCAD running on the Windows operating system: <https://knowledge.autodesk.com/support/autocad/troubleshooting/caas/sfdcarticles/sfdcarticles/Operating-system-compatibility-for-AutoCAD-and-AutoCAD-LT.html>.

AutoCAD for Mac operating systems: <https://knowledge.autodesk.com/support/autocad-for-mac/troubleshooting/caas/sfdcarticles/sfdcarticles/Operating-system-compatibility-for-AutoCAD-for-Mac.html>.

Just as you can try out AutoCAD free for 31 days, you can install and run the Platinum edition of BricsCAD for 30 days at no charge from <http://www.bricsys.com> . You can test the Linux, Mac, and Windows versions. The size of the BricsCAD download file is 264MB, 5x smaller than AutoCAD's 1.8GB download file.

IN SUMMARY, BricsCAD operates much like AutoCAD — yet is much more economical.

—————

In the following chapters, we delve deeper into the themes sketched out by this chapter. But first, a look at what's new in BricsCAD V20.

WHAT'S NEW IN BRICSCAD V20

This list of BricsCAD's new and changed functions was compiled from version 20.3. Changes are highlighted throughout this book, but be aware that information on these pages is not comprehensive, as Bricsys continually updates this software. For information on functions added since this book was published, please see <https://www.bricsys.com/common/releasenotes.jsp>.

New command and variable names are shown here in boldface **blue**, and updated ones in boldface **black**. They are listed in alphabetical order in the following sections:

- New Entities
- Command Name Changes
- User Interface, File Operations, and Printing
- 2D Drawing and Editing
- Blocks, Tables, and Data Extraction
- Dimensioning
- 3D
- Point Clouds
- BIM
- Civil
- Mechanical
- Sheet Metal
- Communicator
- Customization and Security

BricsCAD V20 installs and runs independently from previous BricsCAD versions.

Shape is no longer supplied in a separate program, and is installed with BricsCAD V20. It can be started from the new Launcher dialog box.

NEW ENTITIES

BricsCAD V20 displays surfaces containing t-spline sub-surfaces, NURBS surfaces where control points termination in the shape of a T.

New entities and commands for doing civil engineering work in BricsCAD V20 Platinum. The new entities are:

- TIN surfaces
- Grading entities
- Alignment entities

The commands associated with civil engineering are **Alignment**, **AlignmentEdit**, **AlignmentView**, **Grading**, **Tin**, **TinEdit**, **TinModify**, **TinMerge**, **TinVolume**, and **TinExtract**.

COMMAND NAME CHANGES

Drag is the new name for the **BimDrag** command.

bmInsert and **DesignTable** commands are now available at the BricsCAD Pro license level.

Parameters panel is renamed **Parameters and Constraints** panel as it supports non-parametric 3D constraints.

Plot command now displays the Print command's dialog box, but reverts to command line prompts in unattended mode.

WNDLSTAT variable is renamed **STATUSBAR**, and the **WNDLTABS** variable is renamed **LAYOUTTAB**.

USER INTERFACE, FILE OPERATIONS, AND PRINTING

BricsCAD V20 starts with a new Launcher dialog and then displays a new Start page; these replace the GetStarted dialog box.

- ▶ Launcher displays workspaces to choose from.
- ▶ Start page lists recently opened drawings, and starts new ones from scratch or from templates. BricsCAD

GotoStart command opens the new start tab.

ColorTheme variables toggles between the traditional light theme (1) and the new dark theme (0; default).

CommandLine now allows a foreground color of solid black and a custom background color. When AutoComplete is in use, pressing the backspace key removes one typed character each time it is pressed.

DgnImport command now imports 3D polylines from .DGN files.

DgnImportOptions opens the Settings dialog box at the DgnImport section.

DstConvert converts sheetset DST files to XML format.

DynPiCoords variable displays dynamic coordinate input with relative (0) or absolute (1) distances and angles.

UcsDetect variable is expanded so that dynamic UCS supports entities other than faces of 3D solids:

- 3 — enable for 3D faces and 2D entities
- 2 — enable for 2D entities only
- 1 — enable for 3D faces only
- 0 — disable
- negative — disable, but remember the previous setting

DUCS status bar control toggles what dynamic UCS detects:

- ▶ Faces of 3D solids (default)
- ▶ Other entity types: point, line, polyline, 2D polyline, 3D polyline, ray, xline, arc, circle, ellipse, spline, text, mtext, solid, 3Dface, trace, block insert, viewport, mline, leader, mleader, hatch, helix, camera, light, section, shape, PDF underlay, and image.

Explorer command alerts you when a referenced text style or dimension style is removed

Grip selection process is more efficient. Grips, pickbox, and other glyphs are now scaled automatically for high resolution (4K) displays.

HideSystemPrinters variable allows users to hide Windows system printers in the Print dialog, keeping just the .pc3 printer configurations.

ImageAttach command now loads compressed TIFF files with more than half a billion pixels; this limitation had not affected images in Big-TIFF format which use 64 bit offsets.

IME (input method editor- composition window no longer closes unexpectedly when the mouse is moved over the drawing view.

Layer, PDF, Image, and XRef commands now bring up modeless, dockable panels instead of the Drawing Explorer. Use the ExpLayers, ExpPdf, ExpImage And ExpXrefs commands bring up the Drawing Explorer for these items.

LookFrom widget now remains active during commands, and no longer disappears when entering clean screen mode. But it is no longer active while other application windows are in the foreground.

Manipulator has an improved initial location of the Manipulator for associative arrays. The MIRROR and SCALE options support the C key (hidden Copy option) to make multiple copies with the Manipulator.

NearestDistance variable now controls the types of dimensions displayed: current values, or individual X,Y and Z components of nearest distances. Scaling of arrowheads displayed during zooming is added.

New and **Open** commands that launch another instance of BricsCAD with the /t (template) option create new drawings based on appropriate template, instead of opening the .dwt template file itself. Drawings with errors in AcDbAssocAction records can now be opened as corrupted records are ignored.

Ortho is properly reported in the status bar.

PdfImport command displays an alert message when no objects are imported, or when errors occurs during the import process. The amount of “grainy dust” in the display of PDF underlays of scanned image is reduced, when the PDF display color is set to match the background color.

PeditExt command (for editing polyline vertices and segments) now works with 2D classic and 3D polylines, in addition to light-weight polylines.

Print command is improved when printing layouts with many viewports. **Plot** command now displays the print dialog box in the interactive mode, and behaves as **-Plot** in the unattended mode. When running in unattended or scripted mode, **-Plot** overwrites files silently when **Expert** variable is > 1. Users can choose to use multiple folder paths for the **PlotCfgPath** and **PlotStylePath** variables.

Properties panel Coordinate pickbutton behavior now makes: dynamic dimensions available.

Polar snap (**Snaptype=1**) is now supported with the **PolarDist**, **PolarAng**, **SnapMode**, and **AutoSnap** variables.

Quad now opens correctly on a hot-plugged secondary display. When the quad is turned off, a short-right-click suffices to display the context menu for selected entities. Polyline segments can now be selected as entity filters for quad buttons. The LwPolyline_Edge entity is added to the list displayed in Add Entity Alias dialog box.

Redraw command is improved for drawings with many inserts with attributes located at the drawing origin and when silhouette display is on (DispSilh = 1).

RrRot command improves the calculation of the center of rotation when **OribtAutoTarget** variable is 0 and the selection point is not on any object or surface.

SaveAs command keeps the old name of a not-yet-saved drawing when the SaveAs operation fails.

Screenshot takes a screen grab of the current space, excluding all UI elements

Shell allows non-ASCII characters in paths.

ShowFullPathInTitle variable displays the full document path in the title of the main BricsCAD window, when set to **I**. The title bar displays the name of the lower license level when **RunAsLevel** is applied to run BricsCAD V20 at a reduced level.

Snap previously gave precedence to the point with higher priority when snap points with different snap priorities (e.g. end point and intersection) were inside the snap aperture box; now the winning snap point is the one closest to the cursor. Previously, the distance to the cursor was computed only in the case where the snap points had equal priority.

StatusBar changes the appearance of the Cursor Coordinate values, depending on whether its enabled or disabled.

Structure command gains the option to deselect entities when hiding them via the panel; “on” by default.

Toolbar command now shows previously hidden toolbars when it is repositioned. **Tooltips** variable is now functional and shown in Settings dialog. Toolbars are shown in sub-menus by menu group, and similar named toolbars are further grouped into nested sub-menus.

Toolpalettes command gain support for palette separators.

ViewEdit gains the option to change the selection set of several views, as long as they are the same for all views.

ViewHorizontal rotates the viewpoint to make z=0 (horizontal)

VpMax and **VpMin** commands maximize and restore current viewport. Paper space viewport(s) in model space can now be edited, copied, moved, and erased. VPLOCK status bar button allows users to see and set the display lock status of the active layout viewport.

WndlStat variable is renamed **StatusBar**, and the **WndlTabs** variable is renamed **LayoutTab**.

2D DRAWING AND EDITING

Arc and **Pline** commands change the direction arcs are drawn to clockwise when you hold down the **Ctrl** key.

CopyGuided copies entities along guidelines.

CopyToLayer command copies entities to layers.

-Gradient command is the command-line version of the **Gradient** command’s dialog box.

Hatch command no longer creates undesired associations between hatches and externally adjoining boundaries (e.g. for externally adjoining rectangles). The **-Hatch** command now fills gradient patterns. **HatchGripEdit** adds and removes grips from hatches and gradients.

-ImageAttach command has improved text prompts.

InsertGuided and **-InsertGuided** inserts blocks along guide curves

LAYER command that works on the command-line now allows the locking and unlocking of xref-dependent layers. **LayerP** command now properly reverts changes made by sequential calls to **LayIso**.

The Layer Filter Panel now supports Layer Group filters. Entity selection from locked layers is now available for the **LayOff** and **LayFrz** commands for any block selection setting.

MPolygon objects now support grips.

MText command gains a Paragraph Spacing dialog box. The on-screen mtext editor now offers better support for high resolution displays.

MLeader command no longer allows annotative blocks to be used with block content. MLeader command Creating an annotative mleader in a custom UCS adds an MText copy when mtext content is used.

Number command gains a new parameter, Tolerance: it considers two solids equal when their centroids are within a given tolerance.

ParametricBlock creates a parametric block from entities in the drawing; useful for BEdit.

Project Browser gains the Add Sheet, Add Subset, and Remove Subset options, and the Properties option to Sheet/View/Subset nodes.

Sections can now be updated in the background, enabled by checking the Enable Background Update item in the Project Browser menu. Tree controls are now user-resizable and will always fit in the browser window, and configurable margins are added for view-port placement.

You can now display Sheet/View labels as “number-name”. Also implemented is drag and drop of schedules onto a sheet/layout; you can also drag & drop a Sheet/Subset to another subset. You can extend an existing sheetset from the Project Browser, and there’s a new project setup dialog, too.

Propagate command gains support for features other than windows and doors. This command is faster at the propagation of window features, and section movement.

Its Box select behavior now aligns with BricsCAD’s regular box select behavior.

Two types of propagated details can be parameterized: connections between linear solids and connections between planar solids. This parameterization allows users to apply a detail to target configurations with different geometric parameters, such as layer thicknesses, profiles and angles.

Properties panel can now use Start offset and End offset properties to edit path arrays.

QuickDraw command now draws the projected grid on top of a slab when the user drags the blue quickdraw cursor from the outside (of a building) inwards. It also now copies stairs across multiple floors automatically.

Style command no longer applies the vertical flag for fonts that do not support vertical orientation (all TTF fonts and some SHX fonts).

Text command now displays text using its own color, instead of the color of the current layer, during editing.

UndoEnt undoes property changes to selected entities.

BLOCKS, TABLES, AND DATA EXTRACTION

2D constraints now can be applied to block insertion points, and to entities inside blocks. It is now possible to add flip states to a parametric block by defining flip lines.

AttDef command adds the Select Property context menu item to select properties from the list. The positioning of multi-line attribute definitions is improved. The fields specified in the Default value of single line attribute definitions are preserved after closing the Define Attribute dialog box.

AttSync command now allows wild-card patterns for block names.

BEdit (block editor) and **RefEdit** (reference editor) commands now edit blocks with proxy entities, if they are cloneable, transformable, eraseable, and able to change visibility.

Blockify command now gives users the option to specify the names of the blocks to be created. The input set to the command now supports wipeout entities. Block transformation matrices are now simplified after Blockify executes.

DataExtraction command adds the 'table column total' option. Tables generated from data extractions have improved formatting. Data extraction now offers block views, which are graphical thumbnails that are inserted into tables containing the results from data extraction operations. Changed dragging initiation keypress on the Properties wizard page to **ctrl+right-click drag**, to support context menus.

DataLink command makes tables with attached data links that are compatible with AutoCAD.

Dynamic blocks now sport grips for lookup parameters.

Table command adds the datalink update tool to the quad. Tables with breaks have improved selection and editing. Improved table highlighting when changing "Enable breaks" from true to false. Now you can edit repeating label rows in a sub-table. The command's Datalink update now removes or clears rows when a datalink range shrinks.

DIMENSIONING

Improved the application of dimension text height settings, and text style changes made in the MText editor.

CenterDisassociate disassociates center lines and marks from circles and arcs

DimLayer, **HpLayer**, and **CenterLayer** variables do not accept xref layers as targets.

DimTEdit now behaves properly when dragging an annotative dimension text entity.

DimGap variable now allows only positive values now; a zero value is considered as positive so that there will be no frame around dimension text.

3D

While hovering the vertex of a 3D solid, holding down the **Ctrl**-key displays the coordinates in the roll-over properties panel.

QuickDraw command assigns roof slabs to new floors in buildings.

Sweep command gains an interactive version to allow users to sweep profiles along a sequence of curves (not just a single curve), or just along a portion of the curve(s).

Radial grids are now supported in section views.

POINT CLOUDS

-PointCloudAttach command attach point cloud files at the command line.

PointCloudPreprocess command pre-processes additional file formats, including ReCAP project and source files to produce highly efficient .vrml (Virtual Reality Model) files that attach directly to drawings. You specify the units for the point cloud and a progress indicator shows the status as the pre-processor runs. **-PointCloudPreprocess** is the command-line version.

PointCloudCrop crops the extents of the current point cloud, while **PointCloudUncrop** removes cropping from point clouds.

BIM

(BUILDING INFORMATION MODELING)

AutoRoom and **Bimify** commands find more rooms with walls of a non-standard shape.

BimDrag command has been renamed to **Drag**, and is available in BricsCAD Pro, Platinum, BIM and Mechanical.

BCF (OpenBIM Collaboration Format) panel now allows users to add comments and change properties in the BCF panel. It allows users to view and manage model-based issues based on the BCF standard.

BimApplyProfile command applies profiles to flow fittings and flow fitting faces. When “AutomaticConnection” is on, applying a profile to a flow element causes adjacent elements to adapt. Setting “RestoreConnection” now controls the restoration of structural connections after BimApplyProfile command runs.

BimAttachComposition command now supports alignment options, and extends ply slicing accommodate building elements containing a cylindrical reference face.

BimClassify command gains a new BIM element type called Annotation; it is accompanied by a default template (used in BIMTAG).

BimCurtainWall command now provides connection-type nodes.

BimDecompose command now decomposes composition-based solids into their separate plies.

BimFlip command now works with asymmetric profile-elements, both structural and MEP.

BimFlowConnect command creates tee flow fittings in all T-shaped connections when the ‘AutomaticTees’ option is switched on. Connecting solids with invalid axes now behaves as expected. The command allows generation of a flow layout from an array of flow terminals and a designated main terminal.

BimGrid command now supports anonymous grid blocks in section views, and offer improved snaps. Previews of a BIM grid, and the resulting grid, now use the current “No Selection” properties.

Bimify command now works on selection sets, and you can now specify a project type (Architectural/Structural/MEP) during Bimify.

BimRoom command now labels invalid rooms with an ‘invalid room’ stamp.

BimSection command now changes the clipping state when you press the **Ctrl** key. The default of “on”, which corresponds to dynamic clipping; when off, you can position the section by snapping to entity snap points, when entity snap mode is on.

The command now displays all hatch patterns of the same material at the same scale in the same 2D drawing when working with different scales. It now applies hatch patterns to generated elevations, and section indicators for detail sections and interior elevations on plans.

BimSectionUpdate command now creates room lines, and its performance was improved for non-associative views.

BimSetLoadBearingDirection sets load bearing directions for slabs.

BimSpatialAllocations command adds building and story definitions at the command line.

BimStair command creates straight stairs as a rectangular parametric array, optionally fixed to a wall. You can attach selectable dimensions at the extents of the stair.

BimTag command now allows you to place tags on nested entities manually, and offers a new Composition option. The command now highlights related entities during manual tagging mode.

Mleader styles for BIM objects are now supported.

Pressing the **Ctrl** key during manual tag placement switches between different tags.

The format of the `_TagTypeToStyle.csv` file has been changed to `.xml`. New styles can be added, based on the styles used for automatically placed tags.

BmInsert command now detects if a selected `.rfa` file has been previously imported, and creates an instance of the existing component to reduce file size.

BIM components have been updated with correct naming and classifications. Windows and Door components use index colors instead of true colors.

DisplayAxesForMEP variable now displays the axes of flow bends, reducers and tees, when switched on.

Profiles of flow fittings are now shown in, and can be changed from the property panel.

IfcExport command now supports the IFC4 Standard, and you can select the IFC format (2X3 or 4).

It exports block attributes and component parameters, has improved performance when exporting polyface meshes, and exports profiles as parameterized IFC profiles. It also now exports analysis models.

IfcImport command supports the IFC4 standard and offers a progress meter shows a more accurate indication of the IFC import process.

Invalid symbols in the names of spatial structure elements are replaced to get valid file names for external references.

Windows and doors on a different storey than their containing walls are now correctly positioned when the project structure is imported as a set of xrefs.

Manipulator preserves connections between flow elements and structural elements during rotation.

MatchProp command now offers the option to match BIM properties between BIM objects. The new **BimMatchProp** variable controls its behavior.

Properties of a linear element's axis (start/end points, delta, length) are shown in the property panel and can be edited.

Ribbon in the BIM workspace was re-designed to contains all of BricsCAD V20's new BIM features.

Schedules now generate elevation and plan symbols for windows and doors. A dialog box to create Schedule definitions is now available in the Project Browser.

SectionSettingsSearchPath variable can be configured to specify alternative locations for files containing section plane settings, section, room and grid callout symbols, tag mappings, story indicators and 2D section result layers.

Separate command now retains BIM data as expected.

SetLevelOfDetail command displays render materials and composition plies when set to high..

CIVIL

Alignment creates horizontal, vertical, or 3D alignments on TIN surfaces

AlignmentEdit edits horizontal and vertical alignments

AlignmentView views alignment along TIN surface

AlignmentVInitial creates vertical alignments

LandXmlEexport exports the drawing in LandXML format

Grading interactively modifies TIN surfaces to create grading effects, such as for roads and foundations.

LandXmlImport imports LandXML files into the current drawing

Tin (short for triangulated irregular network) imports data from TIN files to create land surfaces, and converts Civil 3D surfaces to BricsCAD format.

TinEdit adds and removes points, break lines, and boundaries in TIN surfaces.

TinExtract creates a mesh or 3D solid between TIN surfaces or between a TIN surface and elevation or vertical offset.

TinMerge merges two or more TIN surfaces into a single one.

TinModify deforms or smooths TIN surfaces.

TinVolume creates a TIN volume surface between a base and TIN surfaces or an elevation

MECHANICAL

(BM = BRICSCAD MECHANICAL; DM = DIRECT MODELING)

The 3D constraints gain a new **Path** constraint moves a point along a curve specified by an expression and the curve's parameters.

Constraints with numeric parameters can now be geometry-driven, which means their values aren't imposed upon the model; instead, they are derived from the model as other constraints are solved. Geometry-driven constraints can be used as inputs for expressions, including variables, other constraints, associative arrays and component parameters.

The vertices of a 3D solid can now be selected for 3D constraints with the **SelectionModes** variable set to 15.

A 3D constraint icon is now shown when a constrained line, circle or xline is selected.

bmBom command now creates BOM tables with new capabilities, including extraction of built-in properties of components; adjusting units for properties; configuring the sorting rules; adding formula columns and footers; and saving and loading of BOM templates.

bmExplode command adds the option to automatically create an exploded view for a given assembly.

bmExternalize command now forces saving of the current drawing prior to calling this command in batch mode, without asking for file names.

bmMech command now allows selection of blocks and external references to be converted into components.

DesignTable command improves the diagnostics for design table import from a CSV file. Several diagnostic messages were added, including 'invalid column names' and 'unknown error'.

dmFrozenGroup command defines groups of entities that can be frozen by setting the group parameter to a non-zero value. This is equivalent to putting the group on a frozen layer. The group parameter can be also controlled by an expression.

Mechanical Browser now allows group features to be edited via a right-click on the feature's icon. It also allows description editing for nested local definitions, and the animation range works with smaller values.

-Parametererts command now supports string values.

Parameters panel is renamed 'Parameters and Constraints' panel as it supports non-parametric 3D constraints. Unsatisfied constraints are displayed in the color purple. "Show driven", "Show driving" and "Clear unused variables" options were added to the context menu.

SHEET METAL

(SM = SHEET METAL)

Settings for Sheet Metal are now categorized and grouped by feature type.

smAssemblyExport command adds the sheet metal type “Standard part” classification HTML and JSON reports. The “Solid types in reports” setting determines what types of solids will be included in reports, ‘Sheet Metal’ and/or ‘Poor Sheet Metal’.

The new “Report path type” setting determines which file path types will be used in reports: relative (default) or absolute.

The JSON file is generated with a list of reachable components, their solids with unfolding information, and the assembly tree structure (starting at the root).

The HTML report uses relative paths to embedded images.

smExplode explodes bends, forms, hem, junctions, and tabs

smFlangeContour command automatically creates a flange, linked with an existing SM model via a bend, from a provided, closed contour.

smHemCreate command creates different types of hem features.

smJunctionCreate command now creates junction features on curved hard edges between two bends (or lofts).

smSelect command gains a new option, ‘Flat edge’, that suggests the selection of co-planar free edges, similar to the **smFlangeEdge** and **smHemCreate** commands.

smSplit command automatically finds the face to split, based on underlying geometry for input line or point. In case of ambiguity, the UCS associated with the required face is used. The Propagate option automatically suggests multiple splits of a similar type.

smTabCreate command creates a tab connection between two flanges.

smUnfold command has a new option to place the unfolded view (with all necessary annotations) into a Paperspace view. Bend table information is added to the attributes layer of the un-folded part’s .dxf file. The unfolding of models with coincident geometry cases is substantially improved.

ViewBase and **smUnfold** commands place unfolded views of sheet metal parts in paper space using new options.

COMMUNICATOR

Communicator now supports the import of McNeel’s Rhinoceros (.3DM) files. Importable data types are: B-Reps (Solids, Surfaces, Regions), Curves, Meshes, Text annotations, Blocks and Block references, Materials and Layers.

CUSTOMIZATION AND SECURITY

BricsCAD V20 is compiled with Visual Studio 2017. C++ extension DLLs (Dynamic Link Libraries) need to be compiled with the same platform toolset in order to be compatible with BricsCAD V20.

BOM (bills of material) status of a component can now be queried via the components API.

RibbonPanelMargin workspace property specifies the margin, in pixels, along the sides of ribbon panels.

Select a workspace on the Workspace tab, and that workspace's property pane can be expanded by dragging the splitter bar.

LegacyCodeSearch, **TrustedPaths**, and **SecureLoad** variables are read-only but whose values are changed by users with administrator privileges.

Comparing User Interfaces Between AutoCAD & BricsCAD

BRICSCAD DEFINES ITS USER INTERFACE THROUGH A .CUI (CUSTOMIZE USER INTERFACE)

file and of variable settings, just like AutoCAD. While AutoCAD overall has more capability in CUI, BricsCAD provides greater control for users through its extensive collection of additional variables that are not found in AutoCAD.

In this chapter, you learn about the similarities (and differences) between the user interfaces of the two CAD systems, specifically in the following areas:

- ▶ Start screen
- ▶ Command line and prompts
- ▶ BricsCAD's Prompt menu
- ▶ BricsCAD's Quad cursor
- ▶ BricsCAD's Settings vs AutoCAD's Options dialog boxes
- ▶ Properties, Layer, Tool, and Sheet Set palettes (panels)
- ▶ BricsCAD's Mechanical Browser vs AutoCAD's Parametrics Manager
- ▶ Status bar
- ▶ Selection sets
- ▶ BricsCAD's Working sets
- ▶ BricsCAD's Tips widget
- ▶ View cubes
- ▶ BricsCAD's Content Browser and Drawing Explorer vs. AutoCAD's Design Center
- ▶ BricsCAD's Manipulator vs. AutoCAD's gizmo
- ▶ Bricsys' 24/7 vs. Autodesk's 360

COMPARISON OF USER INTERFACES

Right: BricsCAD V20 with default user interface in Drafting workspace

Below: AutoCAD 2020 in default UI of its Drafting & Annotation workspace

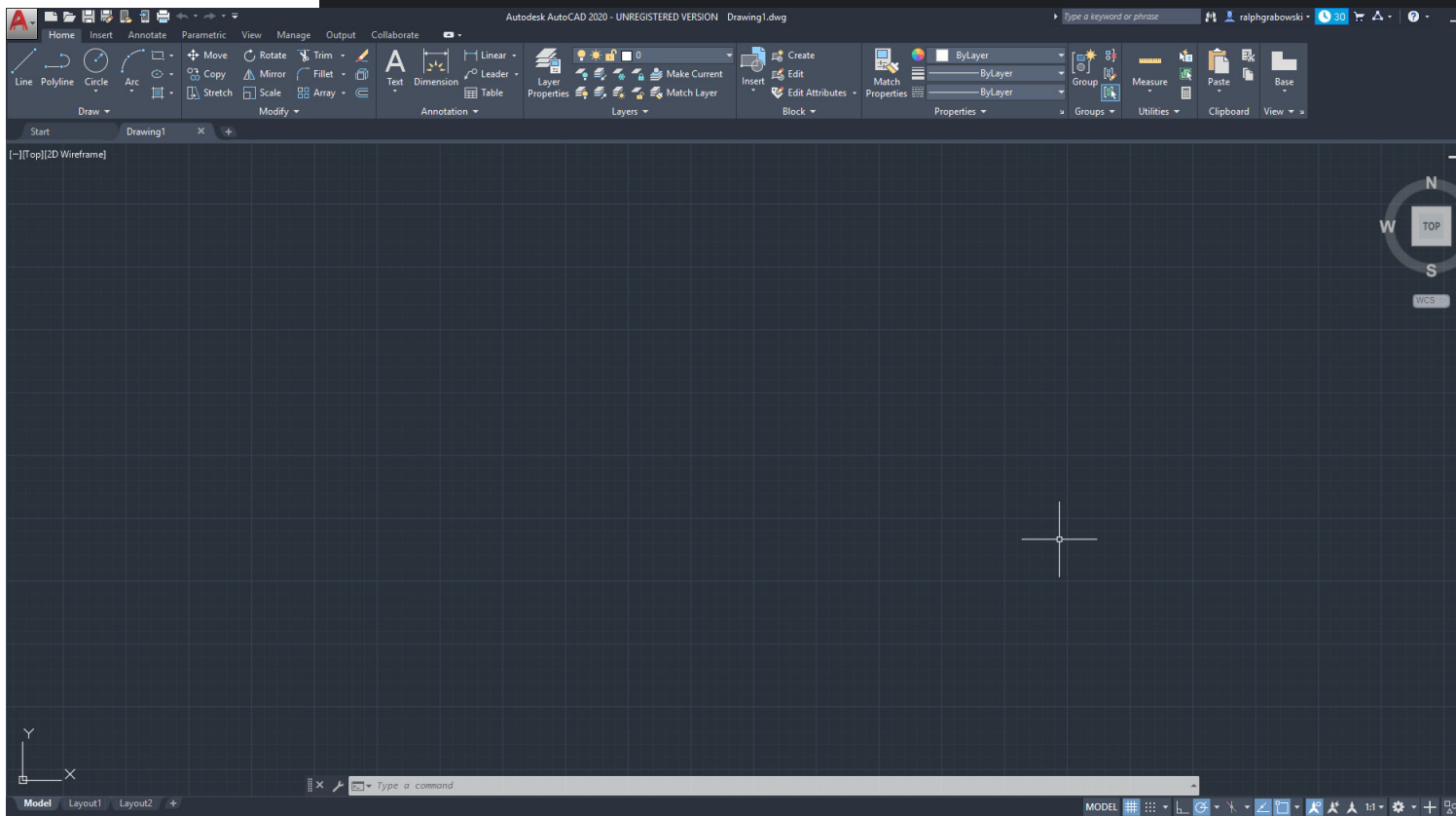
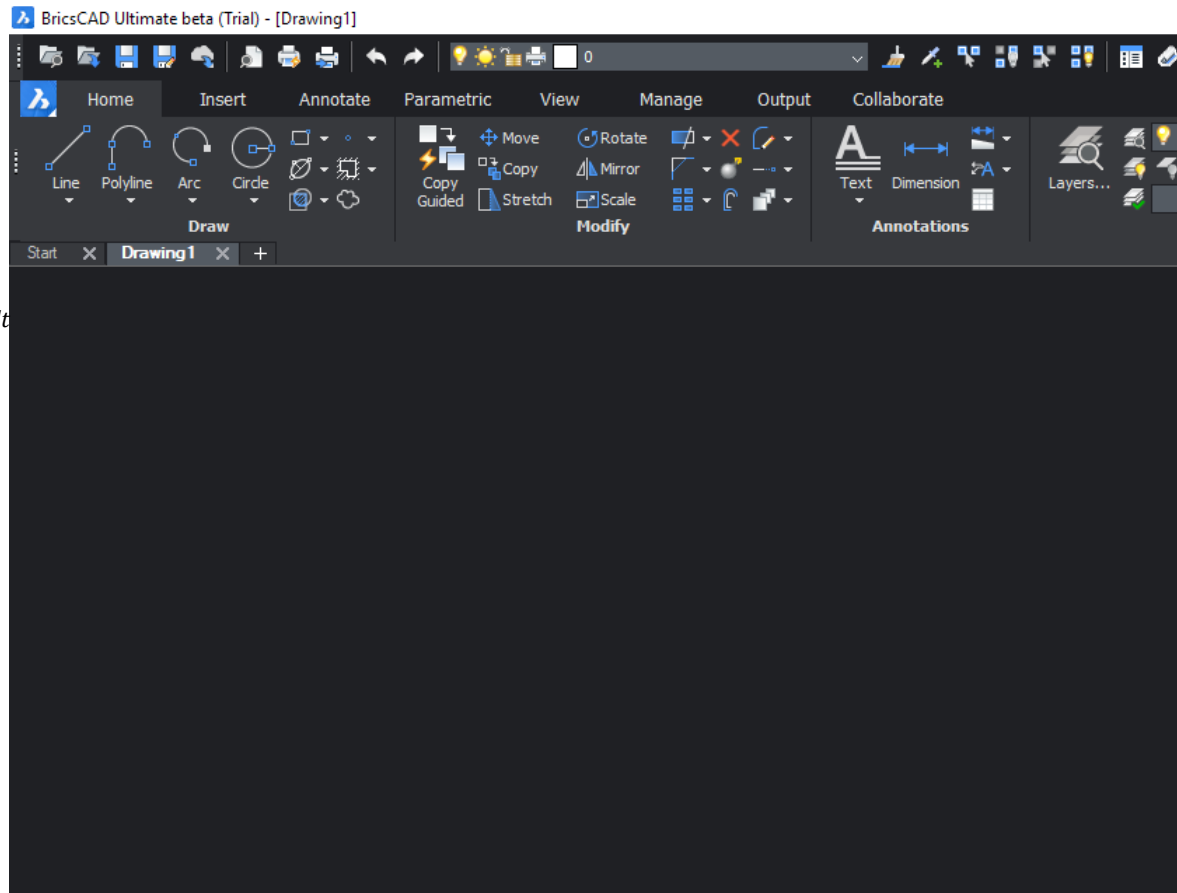

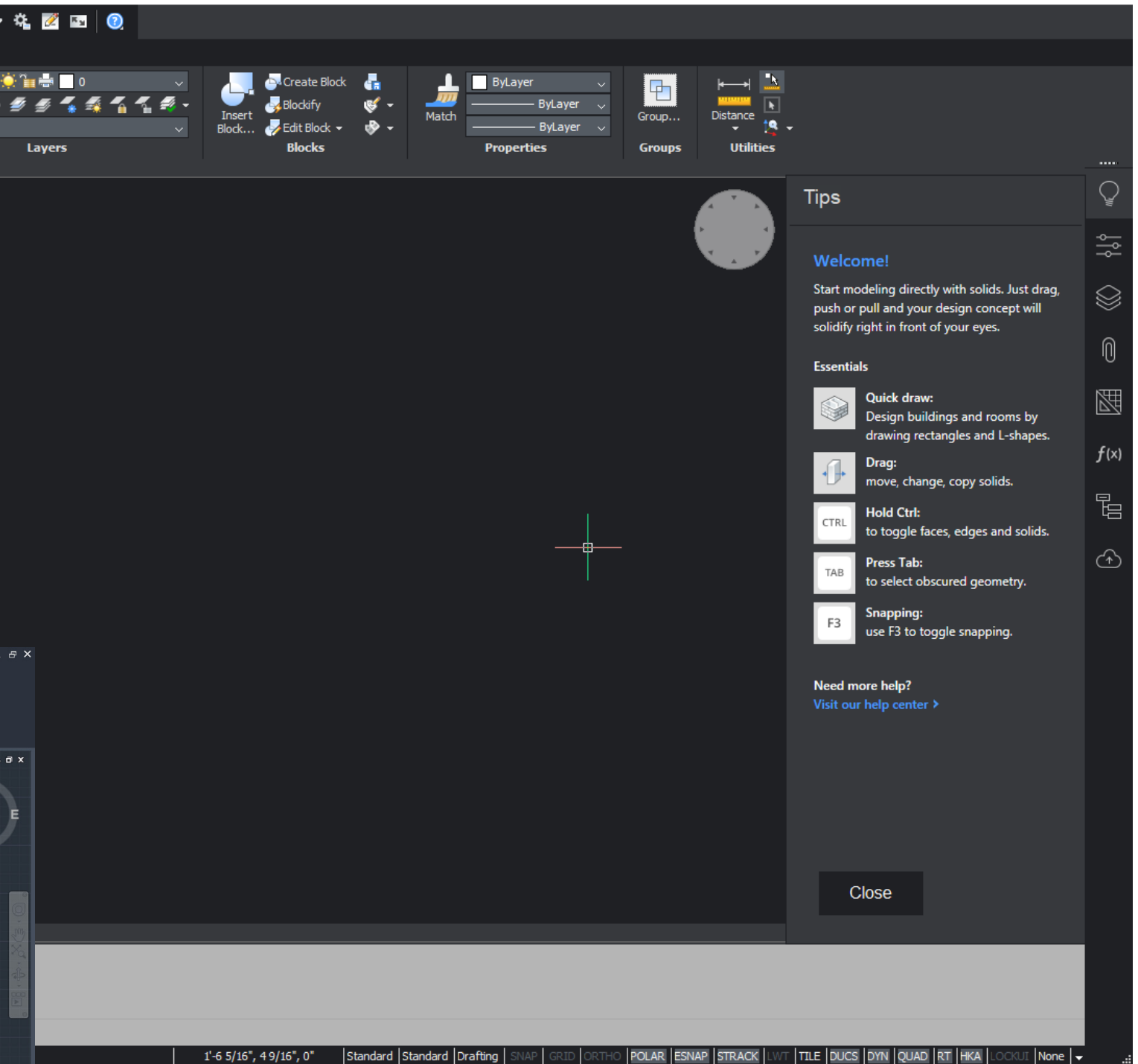

COMPARISON OF USER INTERFACE ELEMENTS

User interface elements discussed in this chapter are shown in **boldface**.

UI Element in AutoCAD	Equivalent Element in BricsCAD
Customizable user interface	Customizable user interface
Drawing tabs	Drawing tabs
Layout tabs	Layout tabs
Menu bar	Menu bar
Ribbon	Ribbon
Rollover tooltips	Quad Quick Properties
Scroll bars	Scroll bars
Status bar	Status bar
Toolbars	Toolbars
Tooltips	Tooltips
Workspaces	Workspaces
QuickView layouts and drawings	...
...	Working (drawing) sets
On the Drawing Screen	
Aperture & pickbox cursors	Aperture & pickbox cursors
AutoSnap markers & autotrack vectors	AutoSnap markers & autotrack vectors
Grips & dynamic block grips	Grips & dynamic block grips
...	Hotkey assistant for shortcut keystrokes
Navigation cube	LookFrom widget
Selection highlighting & previews	Selection highlighting & previews
Selection modes: 14	Selection modes: 18
Steering wheel	Manipulator widget
...	Quad cursor
Sub-entity selection	Sub-entity selection
Tri-color cursor	Tri-color cursor
UCS icon & dynamic UCS	UCS icon & dynamic UCS
Command Bar and Mouse	
3D mouse	3D mouse (see appendix C)
AutoComplete	AutoComplete
...	Customizable command prompt
Double-click actions	Double-click actions (see appendix C)
Dynamic input	Dynamic input
Keyboard input	Keyboard input
Keyboard shortcuts	Keyboard shortcuts
Mouse buttons	Mouse buttons (see appendix C)
...	Prompt (options) menu
Shortcut menus	Shortcut menus

Continued...

AutoCAD and BricsCAD Start Screens

Both AutoCAD and BricsCAD offer aids to help you get started with the software. AutoCAD has a start page, while BricsCAD has a similar start page, plus a launcher dialog box.

LAUNCHER DIALOG (BRICSCAD ONLY)

(NEW IN V20) BricsCAD starts with a Launcher dialog box that lets you access workspaces and manage licenses.

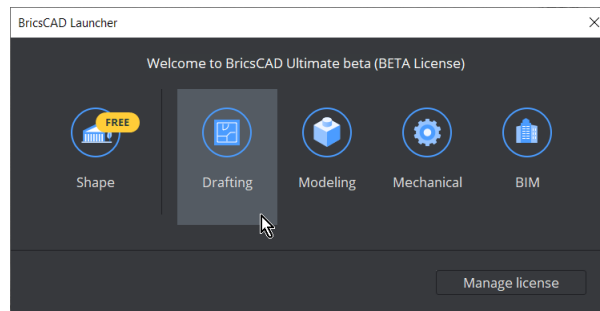

Profile Presets showing workspaces

Click the name of a workspace, such as **Drafting** or **BIM**, to reconfigure BricsCAD's user interface for that kind of CAD work. BricsCAD then enters the start screen.

(Clicking **Shape** runs the free Shape conceptual design program. Clicking **Manage License** enters or changes license numbers for BricsCAD and its add-on modules.)

(new to V20) **TIP** To switch BricsCAD between dark (the default) and light interfaces, enter the **ColorTheme** variable

...continued

Information Centers

DesignCenter	Content Explorer / Drawing Explorer
InfoCenter	Help
Parameters manager	Mechanical browser / Hardware library
...	Prompts on status bar
Properties palette	Properties panel
Quick Access toolbar	Quick Access toolbar
Quick Properties	Quick Properties
Sheet Set Manager	Sheet Set Manager
Tool palettes	Tool palettes panel

Start Page

AutoCAD and BricsCAD both offer start screens. AutoCAD's is illustrated below.

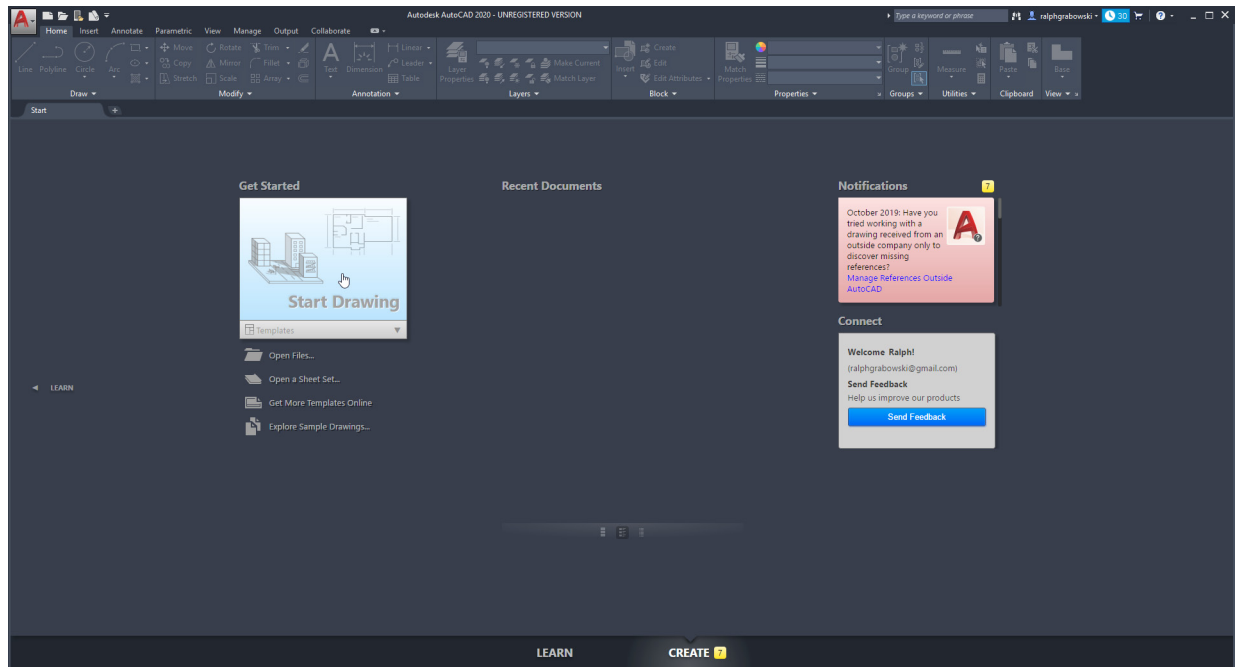

One of the pages of the start screen in AutoCAD

(NEW IN V20) Once you click the name of a workspace in the Launcher, BricsCAD opens with a start page similar to that of AutoCAD:

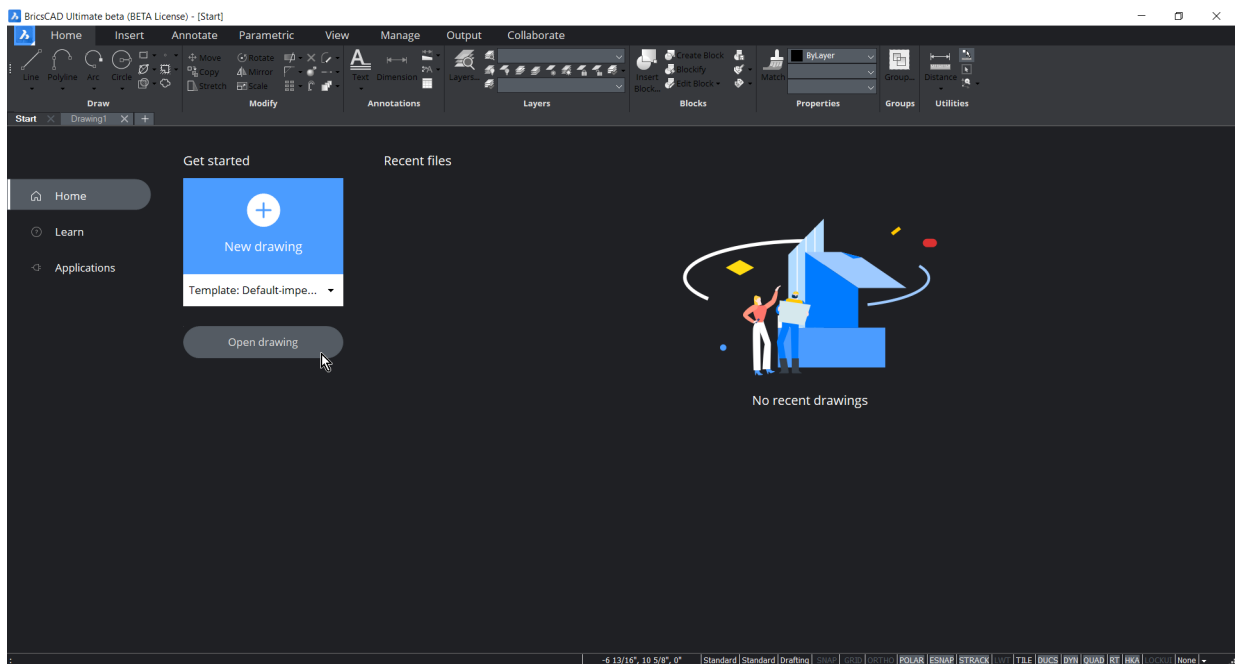

Start page in BricsCAD

From the start screen, you can access the following services:

- ▶ **Get Started/New Drawing** — start a new drawing; optionally, select the name of a template drawing from the droplist
- ▶ **Open Drawing** — accesses the operating system's file manger to select a DWG, DXF, or DWT file to open
- ▶ **Recent Files** — choose a drawing that you opened recently
- ▶ **Learn** — provides access to video tutorials on the Bricsys Web site
- ▶ **Applications** — lists the names of third-party programs that work with BricsCAD; see figure below

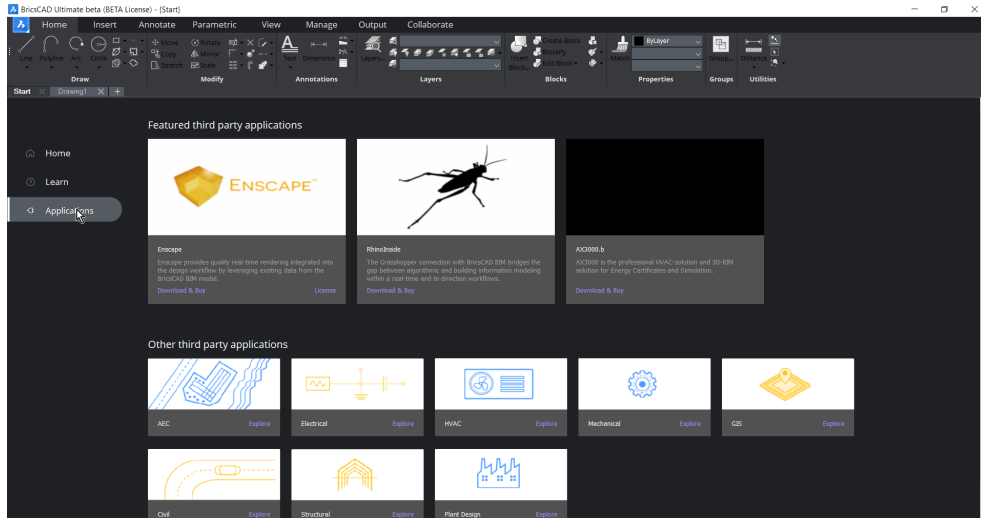

Listing of third-party applications for use with BricsCAD

Comparing User Interfaces

AutoCAD and BricsCAD sport user interfaces that look similar to one other. Both offers the ribbon, panels or palettes, a command bar, the status bar, and so on. For command input, both offer you automatic completion of commands, dynamic input of distances and angles, right-click shortcut menus, and more. For instance, the figures below show BricsCAD's autocomplete function (left) and dynamic input (right), which operate exactly as in AutoCAD.

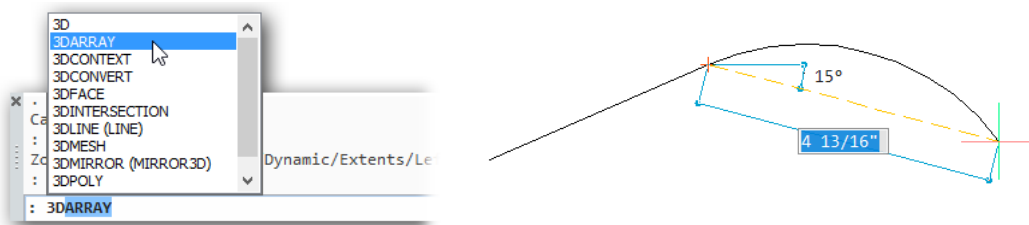

Left: BricsCAD command bar with AutoComplete; **right:** Dynamic input in the BricsCAD drawing area

BricsCAD does have some user interface differences from AutoCAD in the areas of command prompt wording, a prompt menu, and some command options, so let's look at them.

DIALOG BOXES

Many dialog boxes look similar between the two programs. For example, below are the Block dialog boxes for AutoCAD and BricsCAD.

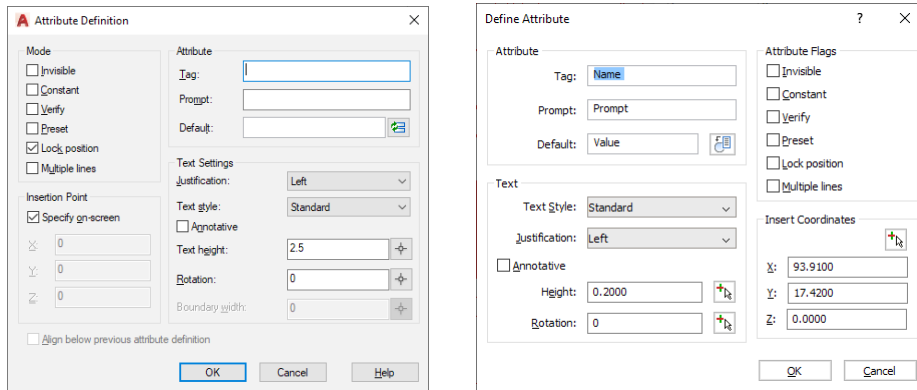

Left: Define Attribute dialog box in AutoCAD; right: ...and in BricsCAD

Other times, however, dialog boxes can look very different. This can be because Bricsys implemented a command differently, such as using the Drawing Explorer to handle most styles, such as text, dimensions, and tables. For these, AutoCAD uses individual dialog boxes.

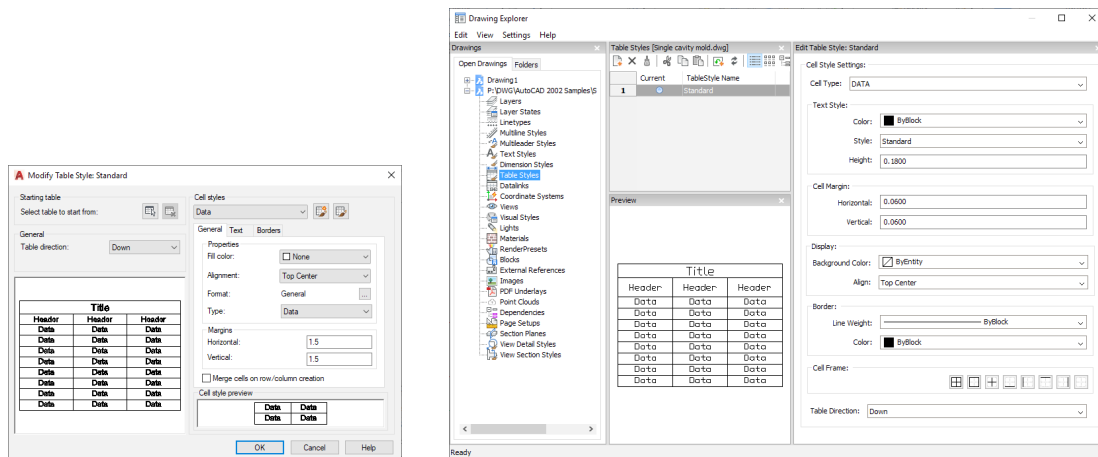

Left: Table Style dialog box in AutoCAD; right: ...and in BricsCAD's Drawing Explorer

Similarly, Autodesk also changes its dialog boxes to a new design, such as for the Insert command.

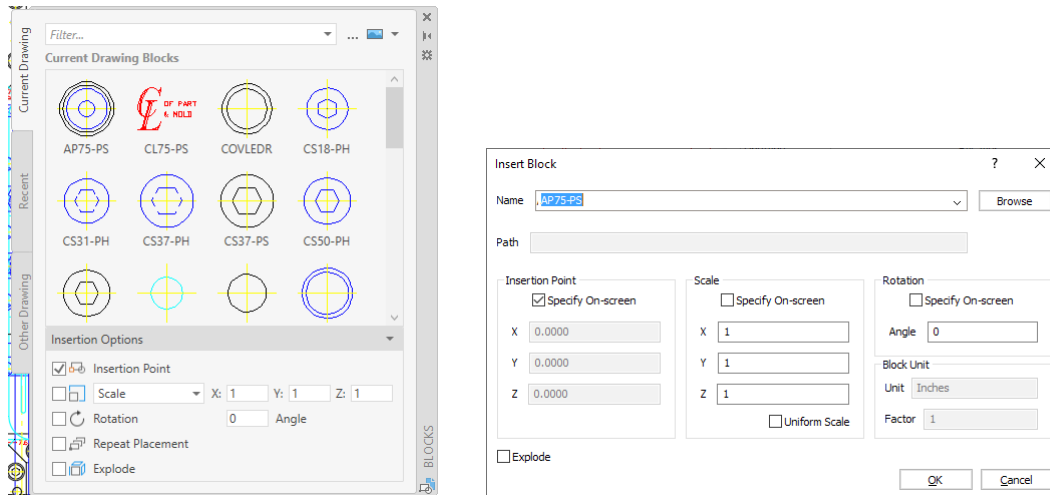

Left: New Insert panel in AutoCAD; right: ...and Insert dialog box in BricsCAD

To use a visual interface for inserting blocks in BricsCAD, use the Components panel. It come populated with a number of blocks, and you can add your own with **Create Component** button.

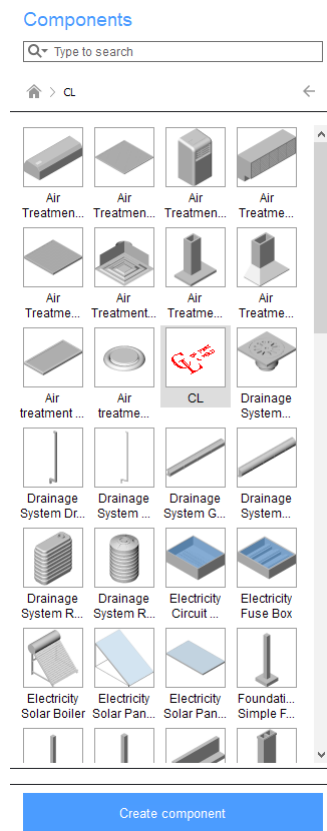

Visually accessing blocks in BricsCAD

COMPARING ':' AND 'TYPE A COMMAND'

For its command prompt, BricsCAD uses the very compact ':' prompt to indicate it is ready for you to enter a command.

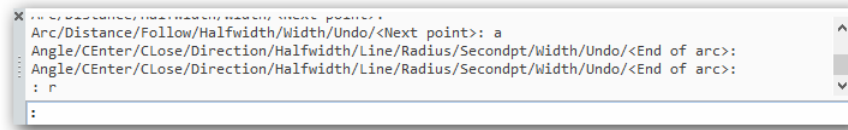

Bricsys command prompt showing the colon prompt (:)

Old releases of AutoCAD used 'Command:' as the prompt, and newer ones display the longer 'Type a command' prompt.

Customizing the Command Prompt (BricsCAD only)

BricsCAD allows you to change the prompt wording; AutoCAD does not. For instance, if you like to see AutoCAD's prompt words — or any other words — in BricsCAD's command area, you are free to change it. To do so, open the Settings dialog box, like this:

1. Enter the **Settings** command to open the Settings dialog box. This is equivalent to opening AutoCAD's Options dialog box.
2. In the search field enter 'prompt prefix', as shown below.

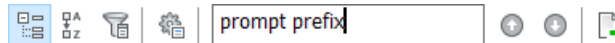

Searching for variable names in BricsCAD Settings dialog box

3. Notice that BricsCAD jumps to the **Prompt Prefix** field. Here you can enter any text you like for the prompt, even silly things like this one. "I feel great today!":

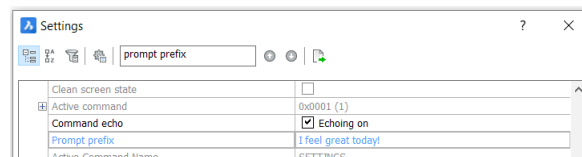

Changing the prompt displayed by the command bar in BricsCAD

4. Exit the dialog box by clicking big red X. Notice that the new prompt text immediately appears.

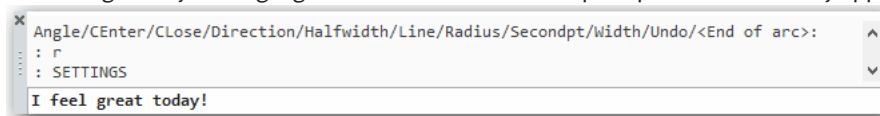

BricsCAD command prompt changed

To further customize command prompts, BricsCAD offers the **PromptOptionFormat** variable that makes command prompts more verbose or less. (AutoCAD does not provide this level of command

prompt customization.) Here are the options for the variable:

PromptOptionFormat	Meaning	Example of Prompt Displayed
0 (default)	Show description only	draw Lines
1	Show keywords only	Line
2	Show description with keywords in brackets	Draw lines (Line)
3	Show description with keyword shortcuts in brackets	Draw lines (L)
4	Show local keyword, with global keyword in brackets	Lineia (Line)

Option 4, in particular, is useful for international versions of the software.

PROMPT MENU (BRICSCAD ONLY)

BricsCAD lets you specify command options through the following inputs:

- ▶ At the keyboard, type in option name or abbreviation
- ▶ With the mouse or finger, tap on the name of the option in the command bar
- ▶ With the mouse or finger: choose among options on the prompt menu (not in AutoCAD)
- ▶ To cancel a command in progress, press **Esc** or click **Cancel**

Another BricsCAD user interface feature not found in AutoCAD is the *prompt menu*. This is a floating menu that appears each time a command offers options. The menu is especially useful when the command prompt bar is turned off. It is, as well, a way to choose options with the mouse or your finger, instead of using the keyboard.

When you start a command, its options appear in the command bar — as well as in the prompt menu.

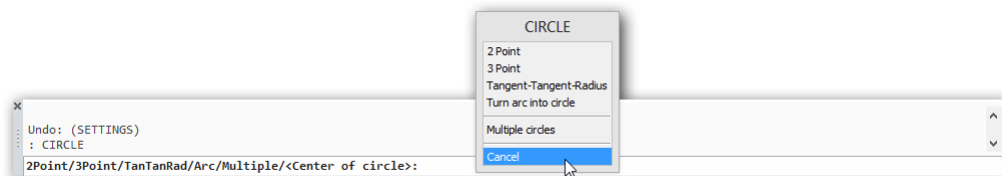

Command bar and prompt menu in BricsCAD displaying options of the Circle command

The figure shows the command bar with the prompt menu superimposed. For instance, as the Circle command progresses, prompts in the command bar and/or the prompt menu change to match one another.

In some cases, the prompt menu does not appear, such as when a command displays a dialog box.

Controlling the Prompt Menu (BricsCAD only)

You can turn the display of the prompt menu on and off, as well as specify its location on the screen.

TIP You can drag the prompt menu to any convenient location, such as on to a second monitor. BricsCAD remembers the location.

In the Settings dialog box, search for 'prompt menu', and then change one of the settings shown below:

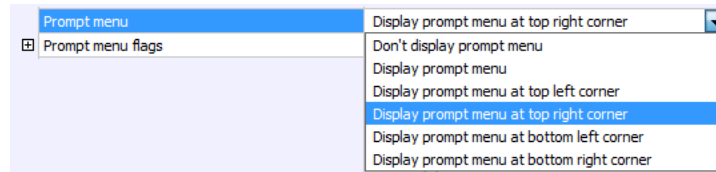

Settings for the prompt menu

Prompt Menu	Options
Don't Display or Display	Determine whether the prompt menu is seen
Corner	Positions the prompt menu near one of the four corners of the drawing area
Show Hidden Options	Prompt menu displays hidden option names in italics; see figure below

When you turn on the **Show Hidden Options** option, the prompt menu lists options that the command-line prompt might not.

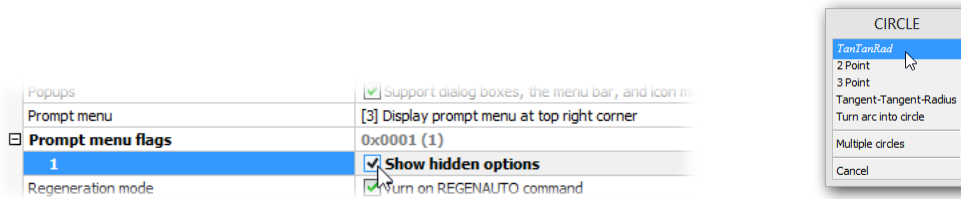

Left: *Toggleing hidden prompt menu items;*
right: *Hidden items, such as TanTanRad, as displayed in italics*

Additional Command Options (BricsCAD only)

You may have noticed that BricsCAD's **Circle** command offers more prompts than does AutoCAD. It is not uncommon for BricsCAD to offer drafters additional commands, options, and variables not available in AutoCAD.

The following table compares the AutoCAD and BricsCAD versions of the Circle command's initial prompt:

AutoCAD Option Wording	BricsCAD Option Wording	Notes
Specify center point of circle	Center of circle	Default option for both CAD programs
2P	2Point	
3P	3Point	
Ttr (tan tan radius)	TanTanRad	
...	Arc	Converts arcs into circles (not in AutoCAD)
...	Multiple	Draws multiple circles (not in AutoCAD)

To compensate for the options missing from some commands, AutoCAD sometimes employs additional commands. To convert arcs into circles, for example, it uses the **Join** command (also found in BricsCAD). To draw more than one circle during the command, it uses the **Multiple** modifier (also in BricsCAD).

THE QUAD (BRICSCAD ONLY)

The Quad offers drawing, editing, and information in a single unit near the cursor.

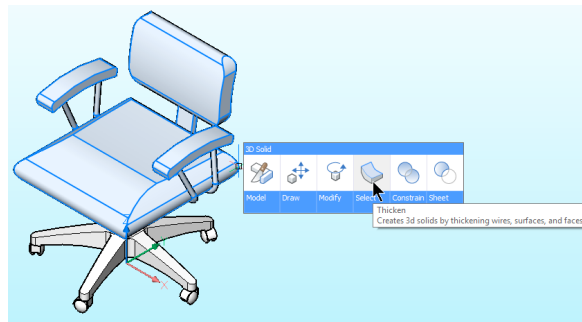

Quad cursor at work in BricsCAD

It is a multifunction cursor, taking its cue from a “heads-up” style of computer interface design. It places many commands right in the drawing area, many of them context-sensitive — meaning some command are specific to the entity selected. The Quad is unique to BricsCAD; AutoCAD does not have this interface.

The Quad works in three ways:

- ▶ **Information mode** — pause the cursor over an entity and when **RT** (Rollover Tooltips) is turned on, the Quad displays information about the entity, just like rollover tooltips in AutoCAD
- ▶ **Editing mode** — click an entity in the drawing and the Quad displays commands related to the entity
- ▶ **Drawing mode** — click a blank spot in drawing and the Quad displays drawing commands

Turning On the Quad

The Quad normally is not visible; most of the time you see the usual tri-color cross hair cursor. You toggle the Quad's appearance by clicking **QUAD** on the status bar.

Displaying Information With the Quad

When you pause the cursor over an entity, the Quad enters information mode and reports some of the properties of the entity.

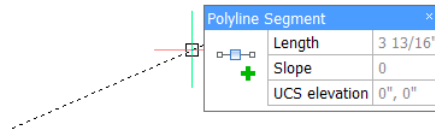

Quad displaying properties of the highlighted entity

TIP If rollover properties are not displayed by the Quad, then click the **RT** (rollover tooltips) button on the status bar.

The information that the Quad reports is equivalent to that reported by AutoCAD's rollover tooltips. BricsCAD uses the "Rollover Tooltip" name, too, even though it is part of the Quad and not a separate tooltip.

The Quad does not have room to display all properties of an entity. If you prefer to see other properties, you change the list through the **Customize** command's **Properties** tab. See Chapter 4.

Editing Properties With the Quad (BricsCAD only)

The Quad also lets you change the properties of the entity: click on the value of a property, and then choose another value (such as color from the droplist, shown below) or enter another value, such as length. (AutoCAD does not do this with its Rollover Tooltips.)

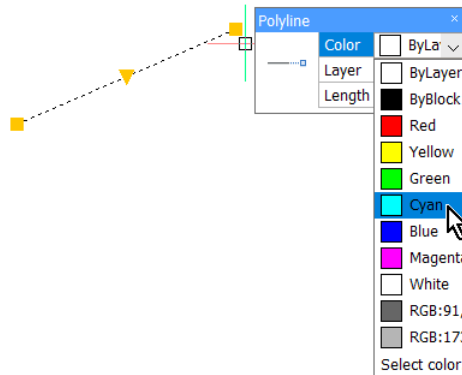

Changing entity properties through the Quad

Editing Entities with the Quad

The Quad lets you edit entities, like this: with the Quad still hovering over the entity, *move the cursor into the properties area*. Notice that the Quad expands to display editing commands.

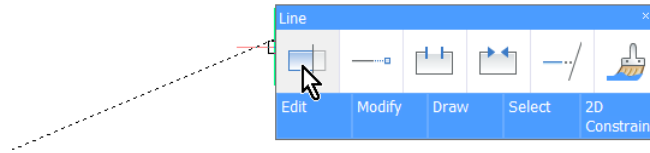

Quad displaying context-sensitive editing commands

Along the top, there are commands specific to editing the selected entity. (Some of these are specific to the workspace that is current.) Pause the cursor over an icon to learn its purpose.

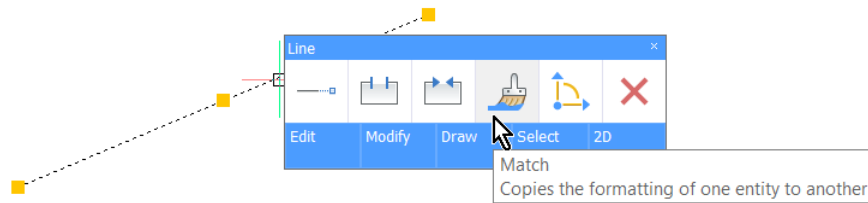

Pausing the cursor over an icon to determine its purpose

Click a button to execute the related command.

Below the first row of buttons, there is a blue band with names of *groups* of commands, such as Edit and Modify. Move the cursor over one of the blue group names, such as **Modify**, and notice how the Quad expands to show the buttons of the group.

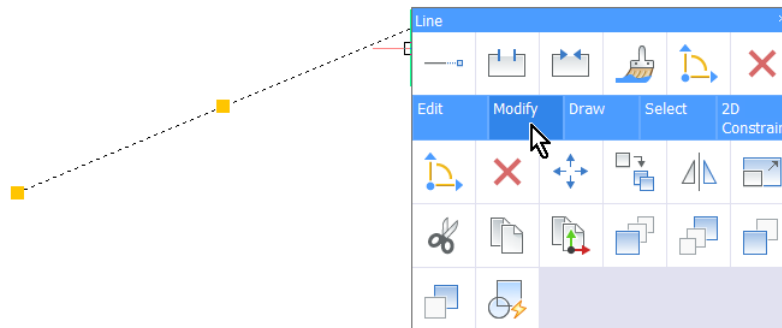

BricsCAD's Quad cursor expanding to expose the command of the Modify group

BricsCAD comes with several sets of predefined Quad cursor setups, such as for 2D drafting and 3D modeling. You customize the Quad through the **Customize** command's Quad and Workspace tabs. See chapter 4.

Drawing With the Quad

When you left-click an empty part of the drawing, BricsCAD displays the Quad with a solitary icon.

TIP If the Quad does not appear when you left-click, then turn it on by clicking **QUAD** on status bar or pressing the **F12** function key.

Generally, the Quad displays the icon of the last-used command, in this case the Line command.

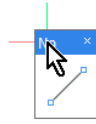

Initial view of the Quad in drawing mode

As you move the crosshair cursor into the icon, the Quad expands to show with icons for carrying out drawing functions.

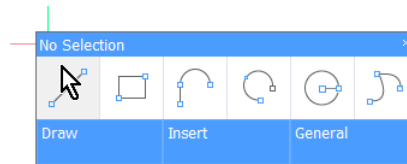

Initial set of drawing commands displayed by Quad

Along the bottom of the Quad is a blue bar with three words: **Draw**, **Insert**, and **General**. Move the cursor into one of them, such as **Draw**. As you do, the Quad expands to display commands related to drawing.

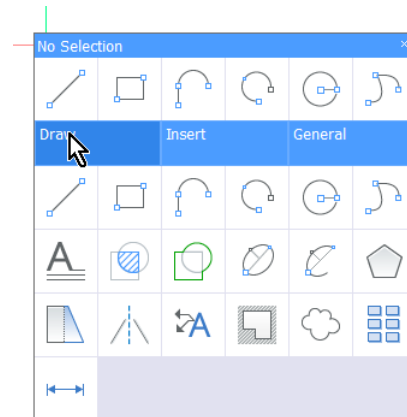

Expanding the Draw section to display icons related to drawing

Click an icon, such as **Text**, to start the associated command.

Comparing Options and Settings

The Options dialog box in AutoCAD accesses many system variables — but not all of them, oddly enough. The equivalent dialog box in BricsCAD is called **Settings** and it accesses *all* 1,200 variables. For your reference, Appendix B provides you with the complete list in BricsCAD, with a comparison of the equivalent system variables in AutoCAD.

Providing users access to over a thousand system settings is a programming challenge: how to make it easy for end users? Autodesk chose to segregate AutoCAD's Options dialog box into ten tabs and over thirty auxiliary dialog boxes. Finding something can be a chore as there is no search facility.

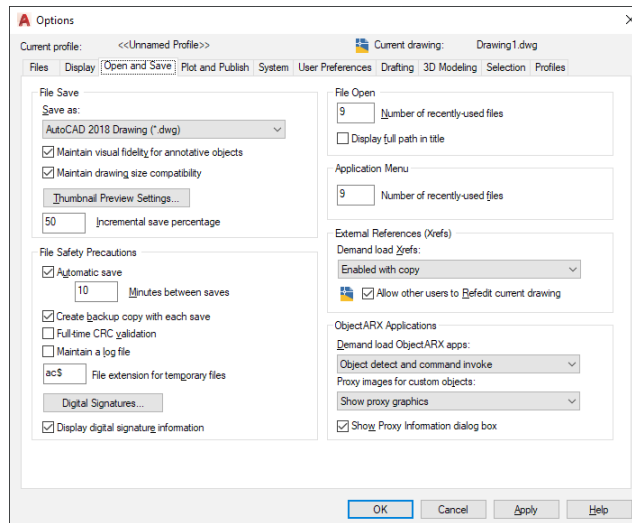

Above: AutoCAD's Options dialog box segregating system variables into tabs, groups, dialog boxes;
Below: The Settings dialog box in BricsCAD with search bar

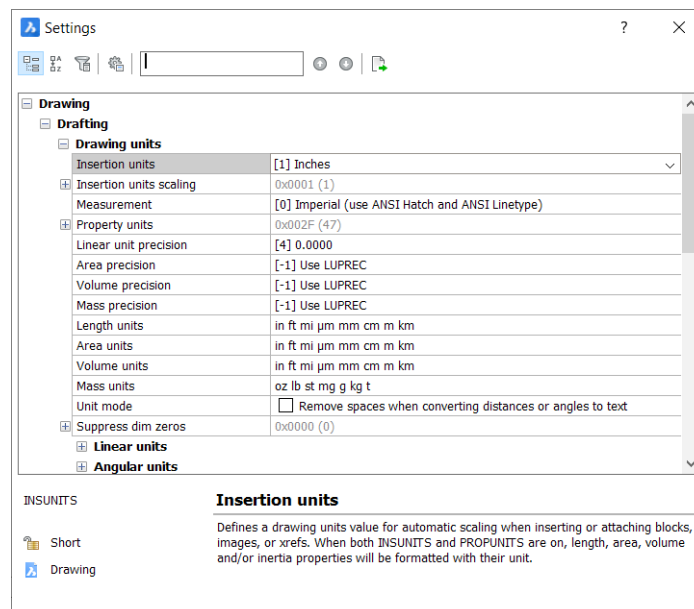

Worse, not all variables are represented by Options in AutoCAD, and so the one you are looking for might be there, or not. In contrast, Bricsys designed a single dialog box so that you can access all variables through a variety of methods:

- › By grouping them logically (as Autodesk does)
- › By listing them in alphabetical order
- › By searching for them with an interactive search box
- › By displaying only those variables whose values have changed from the default values

TIP To restore a value in the Settings dialog box to its default value, right-click the changed entry and then choose **Restore default value** from the shortcut menu.

TOURING THE SETTINGS DIALOG BOX

The Settings dialog box is important to using BricsCAD effectively. As it is deliberately different from AutoCAD's Options dialog box, allow me to give you a tour of it.

To access the Settings dialog box, use one of these methods:





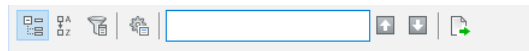

- › Enter the **Settings** command
- › Type the **Options** alias (used by AutoCAD)
- › In the ribbon's **Home** tab, look for the **Settings** panel, and then choose **Settings**
- › From the **Settings** menu, choose **Settings**

Atop the dialog box is the toolbar through which you control access BricsCAD's variables. Buttons change the sort order, search for settings by name, and export settings to a file.



Toolbar atop the Settings dialog box

From left to right, the buttons have the following functions:

- › Clicking one of the first two buttons changes the sort order of variables, between **Categorical**  and **Alphabetical** .
- › Clicking **Differences**  views just those variables whose values changed.
- › Clicking **Configuration**  changes the search options.
- › Entering text in the **Search** field find the variable by name or description.
- › Clicking the arrow buttons  and  jumps to the previous and next instance of the search text.
- › Selecting  **Export** saves variable names and values to a CSV file, which can be opened in a spreadsheet.

In addition, you can use the **SetVar** command to list variables by name and change their values, as in AutoCAD.

Using Real-time Search

You may find that you use the **Search** field a lot, because it's the fastest way to get to a variable and change its setting. As you enter the first few letters of text, BricsCAD immediately jumps to the first word that matches them. It searches among variable names, their descriptions, values, help text, and/or category names. You change the search extents with the Configuration dialog box.

When BricsCAD arrives at a variable name that isn't quite the one you want, click the down  button to move through other matching candidates. (AutoCAD does not offer a search function.) The color of the search field changes to report the status of the search term you entered:

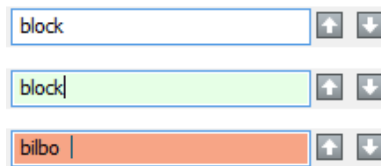

BricsCAD using colors to alert you to the search status

Snow white — two or more names match the search phrase

Lime green — only one name matches the search phrase, or you have reached the last instance of the phrase; click  to begin searching from the top of the list again

Tangerine orange — no name matches the search phrase

Clicking the **Configuration**  button lets you narrow the search through the Find Setting dialog box. You may find, however, that it's best to leave all the **Find Where** options turned on.

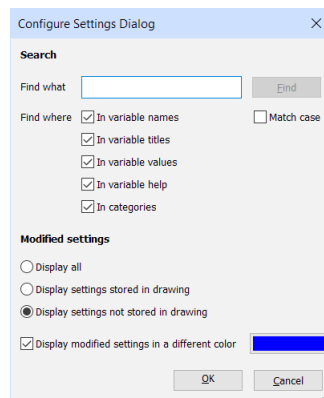



Dialog box for narrowing the search field

The Configure Settings dialog box also controls what the Differences button displays.

Opening and Closing Nodes

Another way to find a variable is to go manually through the list, by categories and name. To keep the list short, BricsCAD employs *nodes*. (AutoCAD's CUI dialog box uses a similar system of nodes.)

Click a  box to open a node, to show a section; click  to close the section.

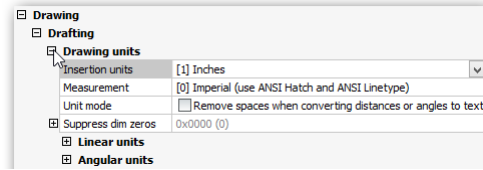

Opening and closing nodes to see and hide sections

Change Alerts

When you change a value, BricsCAD turns it **blue** and **boldface** to alert you that the change has taken place:

- ▶ **Blue** — the value is changed from the default value
- ▶ **Boldface** — the value is changed; the boldfacing disappears the next time you open this dialog box

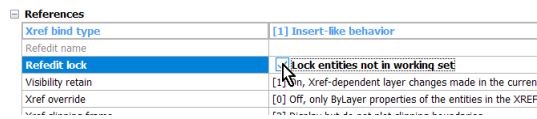

*Boldfaced values have been changed since the dialog box was opened;
blue values are changed from the default values*

To view only the changed variables, click the  **Show Differences From Default** button:

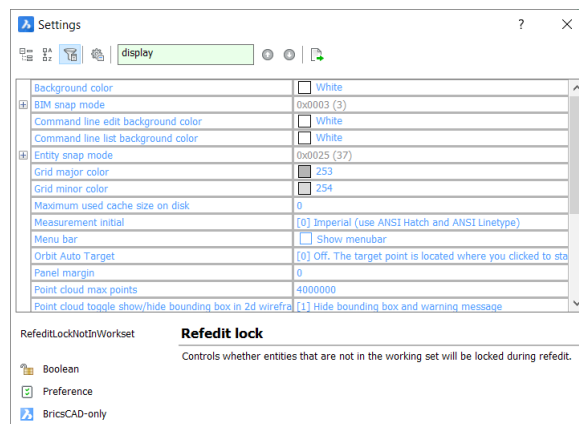

Viewing only changed variables

Click the **Show Differences** button a second time to return to the standard view.

Read-only Variables

There are some variables that you cannot change, because they report the status of the system. They are called “read-only” and are shown in gray text. AutoCAD also has read-only, but does not expose them through its Options dialog box.

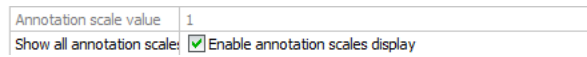

Gray text indicating a read-only setting

Help for Variables

The preview area at the bottom of the Settings dialog box provides brief help for the variable that you’ve selected.

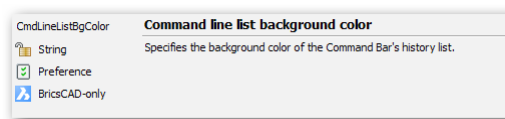

BricsCAD explaining the meaning of variables

The help section uses a variety of font styles to indicate the type of variable:

- ▶ **UPPERCASE** text — system variable also usually found in AutoCAD
- ▶ **Mixed Case** text — preference variable that may or may not be found in AutoCAD
- ▶  icon — setting is unique to BricsCAD, and so is are not found in AutoCAD

Exporting Settings

To export the settings and their current values, click the **Export**  button. This action saves the data in text file formatted in CSV format (comma-separated value). Such files can be imported into LibreOffice Calc or other spreadsheet programs. (AutoCAD does not offer this feature.)

	A	B	C	D	E	
1	Name	Save mode	Save type	Restype	Default value	Current value
2						
3	ACADLSPASDOC	reg	bool	RTSHORT		0
4	ACADPREFIX	not	str	RTSTR		C:\Users\rhg\AppData\Roaming\Bricsys\BricsCAD\
5	ACADVER	not	str	RTSTR		19.0 BricsCAD
6	ACISOUTVER	not	int	RTSHORT		
7	AFLAGS	not	int	RTSHORT		0
8	ANGBASE	dnw	real	RTRFAL		0

BricsCAD settings exported to a spreadsheet

TIP BricsCAD has the same **SetVar** command as AutoCAD for accessing variables. As well, BricsCAD and AutoCAD both let you enter names of system and preference variables directly at the command prompt.

ACCESSING AND MOVING BRICSCAD PANELS

You can open and close BricsCAD panels with commands, but the easiest way to access them is by right-clicking the ribbon or a toolbar, select **Panels** from the shortcut menu, and then choose a name:

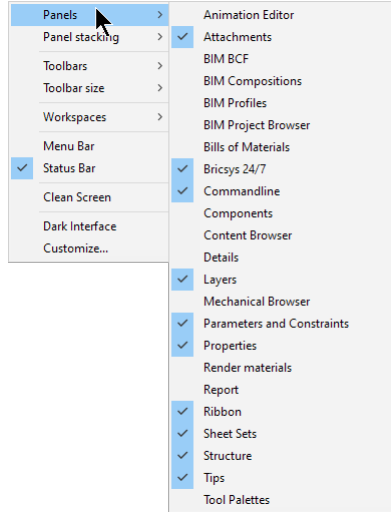

The blue checkmark indicates the panel is open. When many are open, they take up much screen space. One solution: park them on a second monitor. Another solution: overlap them by dragging one panel over another. Notice the blue trapezoids that appear:

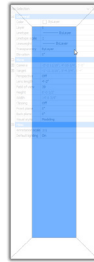

- ▶ Top and bottom trapezoids — panel is parked to the top (or bottom) of existing ones
- ▶ Side trapezoids— panel is parked at the side of the existing one(s)
- ▶ Center rectangle — panels are turned into tabs or icons, as illustrated below, depending on the setting in Panel Stacking.

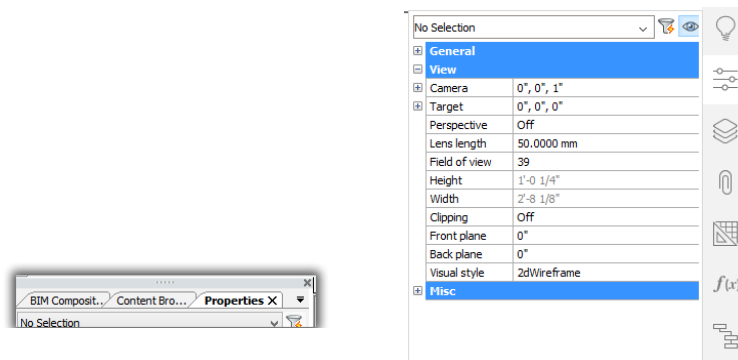

Left: Panels stacked as tabs; **right:** panels stacked as icons

Comparing AutoCAD Palettes and BricsCAD Panels

Here is a comparison of panel-palettes provided by AutoCAD and BricsCAD. BricsCAD uses the word “panel” in place of palette. Those new to BricsCAD V20 are shown in [blue](#).

AutoCAD Palette	Equivalent BricsCAD Panel	Notes
Advanced Render Settings	Explorer Render Presets	BricsCAD edits render settings in the Drawing Explorer *
Command	Commandline	
dbConnect	Explorer Datalinks	BricsCAD edits data links in the Drawing Explorer
DesignCenter	Content Browser	
External References	Attachments	
Layer	Layers	
Lights	Explorer Lights	BricsCAD edits lights in the Drawing Explorer
Materials Browser	Render Materials	
Materials Editor	Explorer Materials	BricsCAD edits materials in the Drawing Explorer
Parametrics	Parameters and Constraints	
Properties	Properties	
Ribbon	Ribbon	
Sheet Set Manager	Sheet Sets	
Tool Palettes	Tool Palettes Components	
Visual Styles	Explorer Visual Styles	BricsCAD edits visual styles in the Drawing Explorer
Palettes Unique to AutoCAD		
Markup Set Manager	...	BricsCAD does not support markups
QuickCalc	...	BricsCAD has no quick calc panel
Panels Unique to BricsCAD		
...	Animation Editor	Control over animating parts of 3D assemblies
...	Bills of Materials	Interactive editing of BOMs
...	BIM Compositions	Defines and edits composite BIM elements
...	BIM BCF	Tracks issues through BIM Collaboration Format
...	BIM Profiles	Profiles of walls and slabs used for BIM designs
...	BIM Project Browser	Navigates elements of BIM projects
...	Bricsys 24/7	Accesses drawings stored on the cloud
...	Details	Creates and edits details for drawings
...	Mechanical Browser	Controls parametric elements
...	Parametric Blocks 2D	Handles blocks made with 2D parametrics (dynamic blocks)
...	Reports	Generates reports
...	Structure	Reports on the drawing's structure
...	Tips	Visual tutorials for using commands

*) BricsCAD's Drawing Explorer is not a panel or palette, but a dialog box.

In the following sections, we look at one panel that is similar in both CAD systems, Properties, and then one panel that both CAD systems have, but operates differently (Mechanical Browser), and finally one that is unique to BricsCAD — Structure.

COMPARING PROPERTIES PANELS

The two CAD packages share a similar-looking Properties palette. To turn on the Properties panel in BricsCAD, enter the **Properties** command; the panel also appears automatically when you double-click an entity in the drawing.

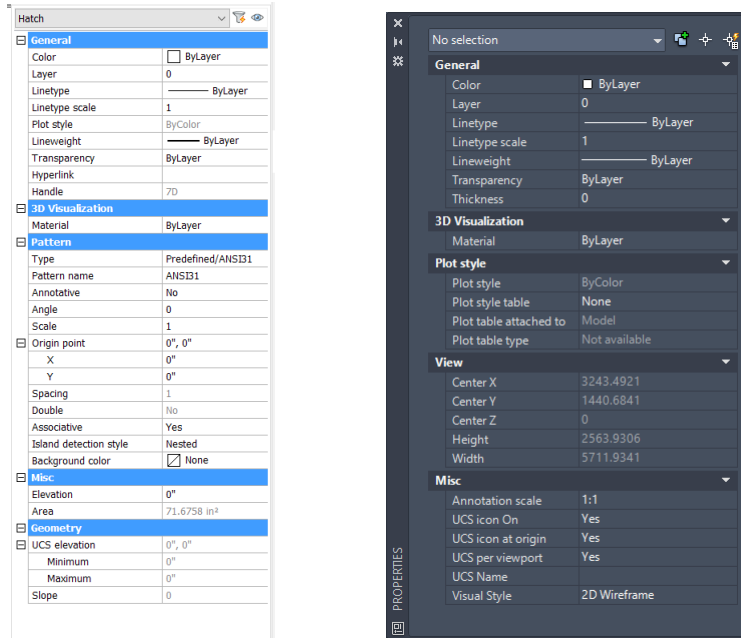

Left: Properties panel in BricsCAD; **right:** Properties palette in AutoCAD

Note In this book, screen images of both CAD packages are set to light theme for clarity.

There is one important difference: BricsCAD employs its Properties panel for most editing functions and for making changes to properties, whereas AutoCAD tends to display command-specific dialog boxes or bring up contextual tabs on the ribbon.

For example, when you click on a hatch pattern in BricsCAD, the Properties panel displays all the options available. AutoCAD, by contrast, displays the Hatch Edit dialog box or else options in a contextual ribbon.

As in AutoCAD, BricsCAD assigns double-click actions to entities, which then display the Properties panel with the parameters appropriate to the entity. (See chapter 4 more on this.)

COMPARING MECHANICAL BROWSER AND PARAMETRICS MANAGER

Both CAD systems offer parametrics constraints, but here BricsCAD outdoes AutoCAD. AutoCAD has only 2D constraints, while BricsCAD has 2D and 3D ones. The Mechanical Browser in BricsCAD shows the sophistication of its 3D parametric modeling capabilities. (Three-D constraints are not available in AutoCAD.)

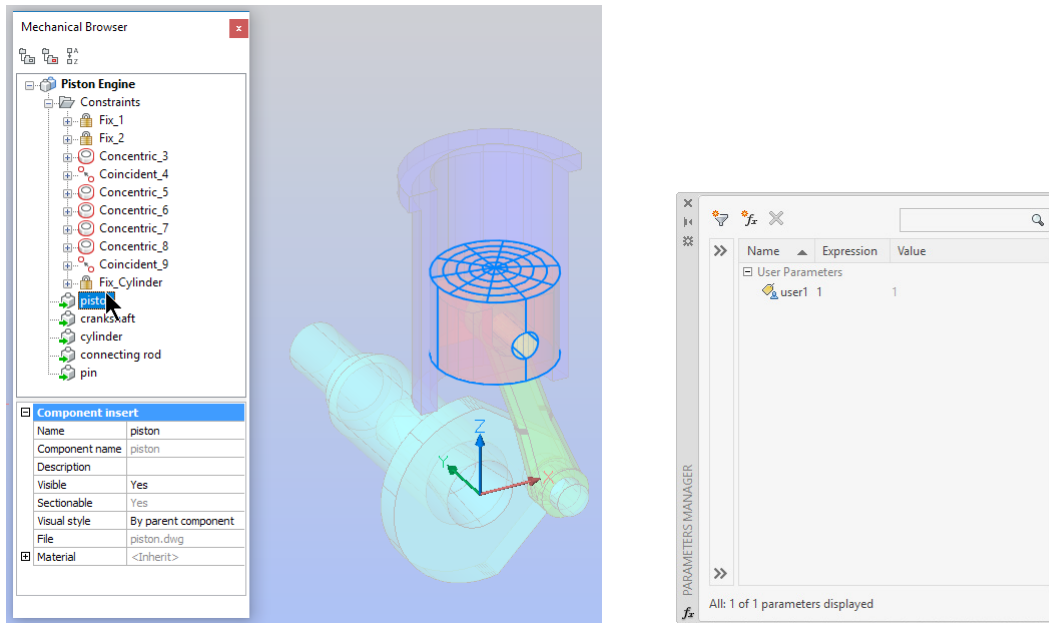

Left: BricsCAD's Mechanical Browser handles constraints, parameters, and assembly parts;
right: AutoCAD's Parametrics Manager with constraint formulas only

The table illustrates the differences in the capabilities of constraints in BricsCAD and AutoCAD:

Feature	BricsCAD	AutoCAD
2D geometric constraints	12	12
2D dimensional constraints	8	6
3D geometric constraints	7	No
3D dimensional constraints	4	No
Formulas in constraints	Yes	Yes
Formulas in arrays	Yes	No
Assemblies from parts	Yes	No

BricsCAD reads constraints from AutoCAD drawings, thanks to the Open Design Alliance's Drawings SDK (software development kit). Sadly, constraints created in BricsCAD models are not recognized by AutoCAD:

- ▶ AutoCAD uses the constraint engine from Siemens PLM Software
- ▶ BricsCAD uses a constraint engine it developed itself

Structure Panel (BricsCAD Only)

The Structure panel displays a structured tree-like view of the current drawing's content, such as entities and groups of entities, like blocks. When you select an entity in the structure tree, you can highlight it, zoom into it, and select it in the drawing — and vice versa. The panel operates in model space only.

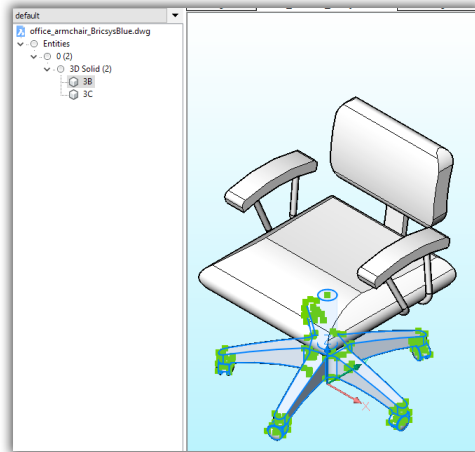

Structure panel showing the structure of the drawing

The format of the Structure panel is customized through the Configure dialog box, and then saved and loaded through .cst configuration files.

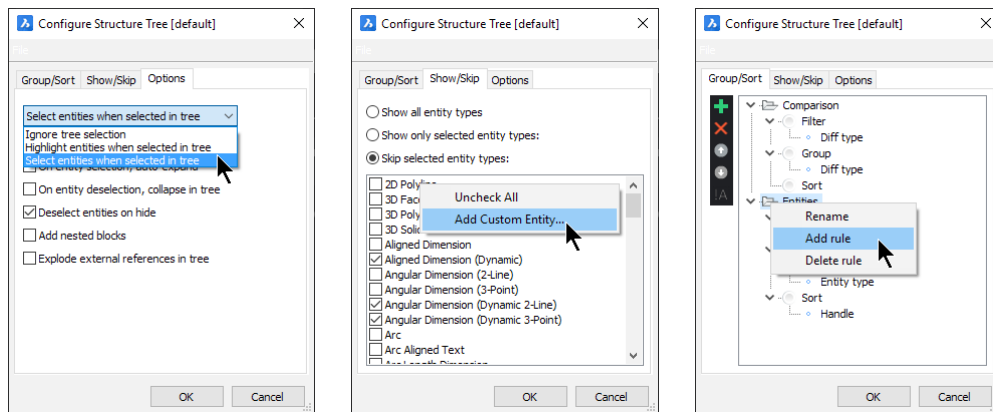

Configuring the Content Browser panel

Bricsys provides three .cst files in the `C:\Users\userid\AppData\Roaming\Bricsys\BricsCAD\V20x64\en_US\Support` folder: Default, Mechanical, and BIM.

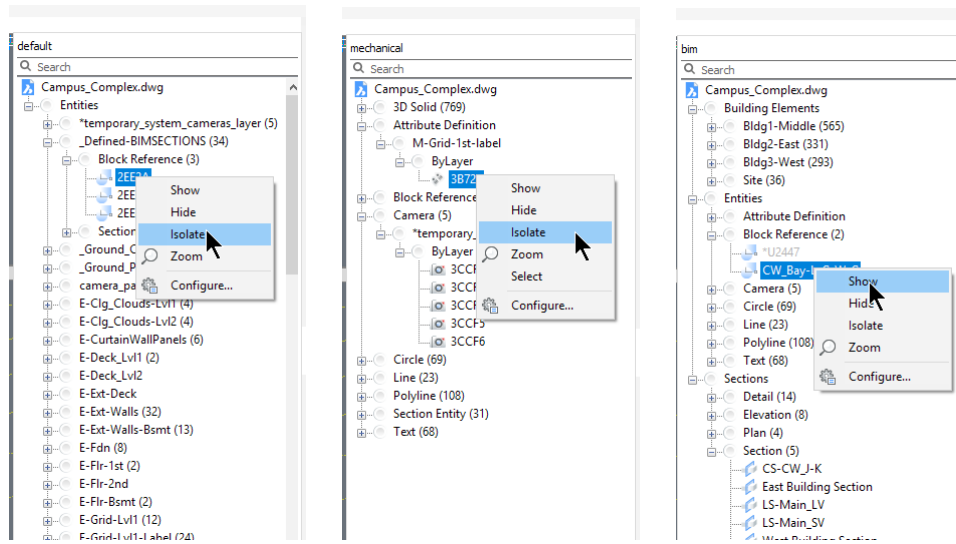

Left to right: Structure panel customized for general drawings, mechanical ones, and BIM drawings

Status Bar & Other UI Differences

Here I provide you with overviews of a few more user interface elements: the status bar, working sets (BricsCAD only), selection sets, DesignCenter vs Drawing Explorer, and Autodesk 360 versus Bricsys 24/7. In all of these cases, the BricsCAD version of the UI element provides you with more utility than does AutoCAD.

COMPARING STATUS BARS

The status bar in BricsCAD reports the status of the drawing, just as AutoCAD does. There is a significant visual difference between the two CAD programs: BricsCAD labels its buttons with text, while AutoCAD uses icons primarily, which might be confusing to decipher:



Above: Status bar in AutoCAD; below: ...and the status bar in BricsCAD

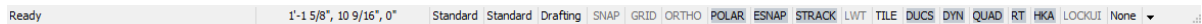

You right-click a toggle on the BricsCAD status bar to access options, as in AutoCAD.

BricsCAD, goes a step further: to change a text or dimension style, you just right-click the current name, and then choose a different one from the shortcut menu. (AutoCAD does not offer this function.)

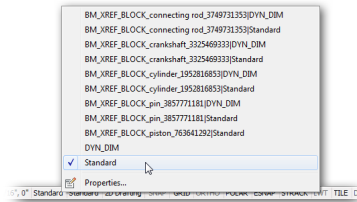

Accessing dimensions styles from the status bar in BricsCAD

All coordinate options are accessed from a single status bar button, while AutoCAD requires two buttons for the same job.



Left: Accessing units formats from the status bar in BricsCAD; right: AutoCAD requiring two status bar buttons

Right-clicking the at the right end of the status bar produces a menu in BricsCAD and AutoCAD. It controls the items seen on the status bar.

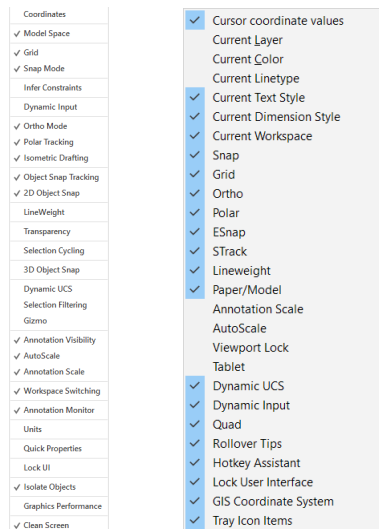

Right: AutoCAD's toggles for items displayed on status bar; Left: ...and those in BricsCAD

The BricsCAD status bar does double duty: the program's prompts appear on the status bar, which is useful when the command bar is turned off. (AutoCAD does not provide this function.)

ENTER to use last point/Follow/<Start of line> 408.7784, 259.5723, 0 S

Status bar in BricsCAD displaying command prompts

BricsCAD status bar has toggles not found in AutoCAD:

Status Bar Item	AutoCAD	Displayed in BricsCAD As	Notes
Current layer name	...	0	
Current color	...	ByLayer	
Current linetype	...	ByLayer	
Current text style	...	Standard	
Current dimension style	...	Standard	
Command prompts	...	Readt	When command bar is turned off
Hot Key Assistant	...	HKA	
Quad cursor toggle	...	QUAD	
Tablet	...	TABLET	
Tips widget	...	TIPS	

Status bar toggles in common with AutoCAD and BricsCAD:

Displayed in Status Bar Function	AutoCAD	BricsCAD As	Notes
Annotation scale	Yes	1:1	
AutoScale	Yes	AutoScale	
Cursor coordinates	Yes	1,2,3	
Diesel prompts	Yes	Yes	Done with the ModeMacro command
Dynamic input toggle	Yes	DYN	
Dynamic UCS	Yes	DUCS	
GIS Coordinate System	(Yes)	Yes	AutoCAD displays geo coordinates in Coordinates field
Grid toggle	Yes	GRID	
Lineweight toggle	Yes	LWT	
LockUI	Yes	LockUI	
Model / Tile	Yes	TILE	
Object snap toggle	OSnap	ESNAP	
Object tracking	OTrack	STRACK	
Ortho toggle	Yes	ORTHO	
Polar toggle	Yes	POLAR	
Rollover Tooltips	Yes	RT	
Snap toggle	Yes	SNAP	
Tray Icon Items	Yes	Yes	
Workspaces	Yes	Drafting	

AutoCAD status bar toggles not found in BricsCAD:

Status Bar Function	AutoCAD	BricsCAD	Alternative in BricsCAD
Annotation visibility	Yes	...	
Infer Constraints	Yes	...	Design intent
Isometric Drafting	Yes	...	Isometric mode
Transparency	Yes	...	Set transparency through Properties panel
Selection Cycling	Yes	...	Cycles through selections with Hot Key Assistant
Selection Filtering	Yes	...	Selection cycling toolbar
Gizmo	Yes	...	Manipulator gizmo
Units	Yes	(Yes)	Right-click Coordinates on status bar
Quick Properties	Yes	...	BricsCAD does not have Quick Properties
Graphics Performance	Yes	...	Variables that set graphics performance
Clean Screen	Yes	...	Press Ctrl+o

WORKING SETS (BRICSCAD ONLY)

A *working set* groups drawings by name. With it, you can load two or more drawings simultaneously into BricsCAD. The **Workset** command is very useful, because Bricsys has implemented threaded file opening, This uses the computer’s multi-core CPU to loads multiple drawings at the same item. (AutoCAD does not have work sets; a workaround is to use sheet sets.)

After BricsCAD opens, you access worksets through the **Workset** command.

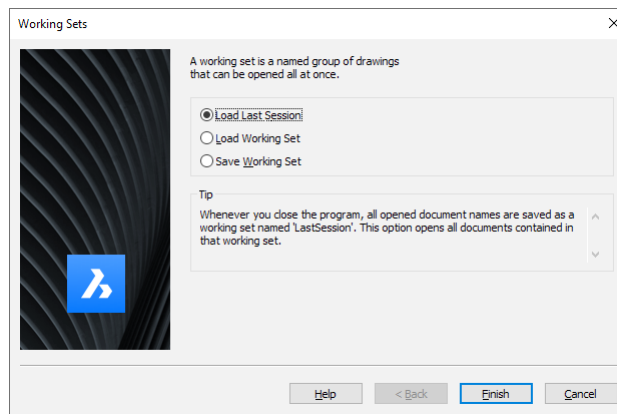

Dialog box for loading and saving working sets

When you close BricsCAD, it saves the names of all open drawing files automatically as a temporary working set under the generic name of “Last Session.” This means you can you easily open all previous drawings the next time you start BricsCAD with Last Session.

HOTKEY ASSISTANT (BRICSCAD ONLY)

The hotkey assistant are like interactive toolbars. (AutoCAD has nothing like this.) They pop up at the appropriate time to report command and selection set options that might otherwise be unknown to you. (Prior to V19, these were known as “Tips.”)

For example, the following assistant appears during the **Polysolid** command. It lets you pick the side on which of the center line the solid should be placed: left, center, or right.



Tips widget showing options for the Polysolid command

The assistant shows several icons.

- ▶ ‘i’ explains what it’s for
- ▶ **Ctrl** icon reminds you to press the **Ctrl** key during the command to change the option
- ▶ **x** closes the assistant

The display is toggled through the **HKA** button on the status bar. Right-click the button and click **Configure** to access a dialog box that lets you determine which command actions activate the assistant — as well as being a handy checklist for which commands display HKAs.

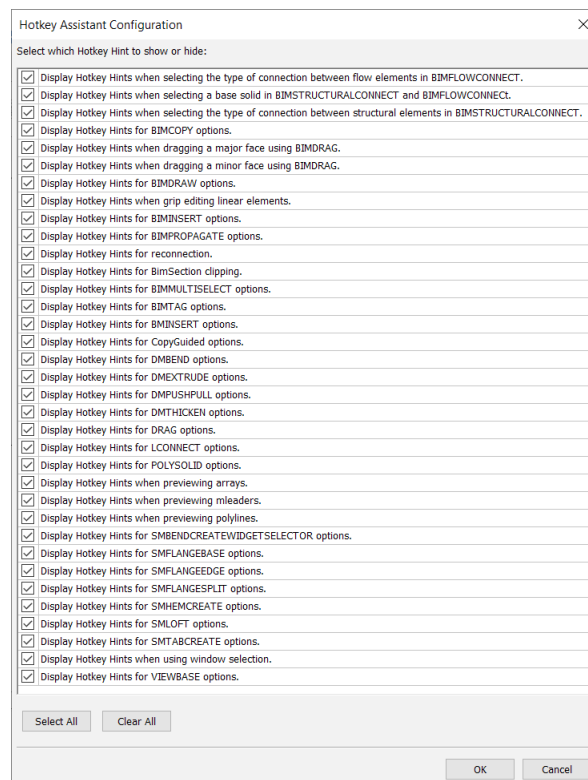

Dialog box for controlling the Hot Key Assistant

COMPARING VIEW CUBES

AutoCAD has the navigation cube for quickly changing 3D viewpoints; in BricsCAD, it is known as the LookFrom widget. Its purpose is to show instantly standard and isometric viewpoints.

Passing the cursor over the widget's small triangles displays previews of a rudimentary chair; clicking the triangle changes the 3D viewpoint. Hold down the **Ctrl** key for the bottom views.

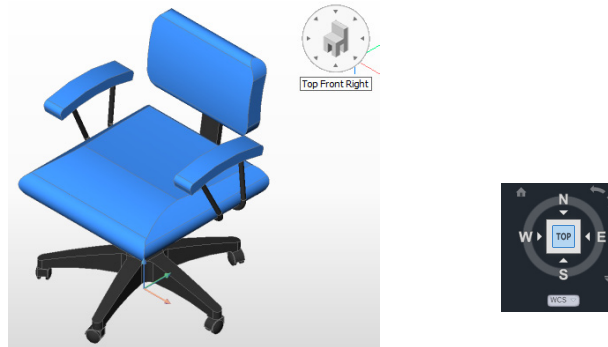

Left: LookFrom control in BricsCAD; right: ViewCube control in AutoCAD

To change the way the LookFrom control operates, enter the **LookFrom** command to turn it off (and on) and access its settings. You would probably turn it off for 2D drafting.

```
: LookFrom  
LookFrom [ON/OFF/Settings] <ON>:
```

The **Settings** option opens the Settings dialog box at the LookFrom section. Here you adjust the properties of the widget, such as its translucency and the number of isometric viewpoints it displays (Direction Mode).

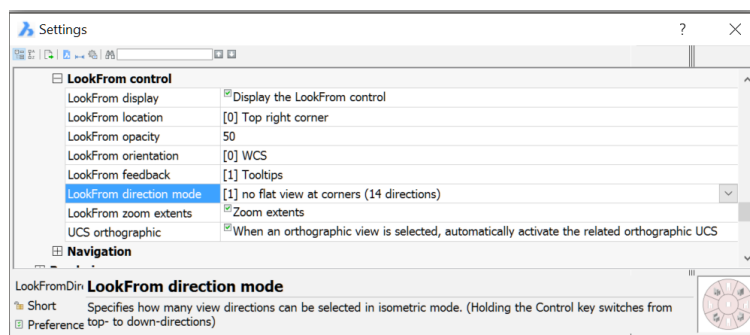

LookFrom properties in the Settings dialog box

The other method to adjust the LookFrom settings is to right-click the control, and then choose an option from the shortcut menu.

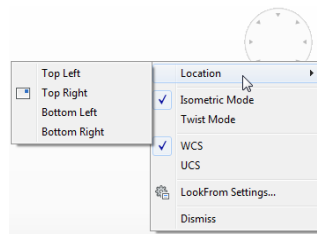

Context menu for the LookFrom control

There are two ways to rotate the 3D viewpoint, **Isometric Mode** and **Twist Mode**:

- ▶ **Isometric** mode works like the Viewpoint and View commands
- ▶ **Twist** mode works like the RtRotF (3DOrbit) command

The green dot indicates the cursor position, kind of like a laser pointer:



Left: LookFrom widget in isometric mode; **right:** ...and in Twist mode

TIP When in Twist mode, click the center of the LookFrom control to return the view to its home view.

Press the **Home** key to return the 3D viewpoint to the “home” view, of then plan view.

COMPARING SELECTION SETS

You assemble complex selection sets in BricsCAD through entity location (pick, Window, Crossing, and so on) and/or properties (color, linetype, and so on), as in AutoCAD. Many actions are the same between the two CAD programs, such as pressing **Ctrl+A** to select all objects in drawings. BricsCAD offers sub-entity selection of 3D objects (faces, edges, and vertices), like AutoCAD.

BricsCAD uses colors to report to the user whether the current selection set is a crossing, window, or other, like AutoCAD. Unlike AutoCAD, however, BricsCAD also displays representative icons; see below. (The closest AutoCAD has to the icons are *cursor badges* to show the command in effect.)



BricsCAD uses colors and icons to report the style of a windowed selection:
Left: Making a windowed selection; **right:** Making a crossing selection.

BricsCAD's **Select** command displays the names of options when you enter '?':

```
: select
Select entities to include in set: ?
Select entities: ALL/Add/+ /Remove/- /Previous/Last/Window/Crossing/Outside/WPolygon/CPolygon/OPolygon/WCircle/CCircle/OCircle/Box/Point/Fence/Auto/Multiple/Single/PROPERTIES/Dialog/Undo/Group:
```

(AutoCAD's Select command does not, except by the workaround of entering the name of a invalid option, such as 'heck'.)

The **Dialog** option displays the Settings dialog box for making changes to how entities are selected.

AutoCAD has a lasso selection mode and off-screen selection, not found in BricsCAD. On the other hand, BricsCAD has selection modes not found in AutoCAD:

- ▶ **Outside window (O)** — selects all entities fully outside of a rectangular window

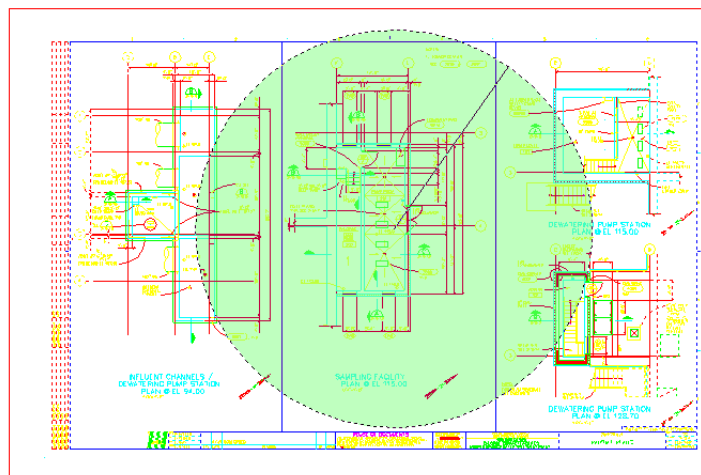

BricsCAD selecting all objects inside a circular selection window

- ▶ **Outside polygon (OP)** — selects all entities fully outside of an irregular polygon
- ▶ **Window circle (WC)** — selects all entities fully within a circle
- ▶ **Crossing circle (CC)** — selects all entities within and crossing a circle; see figure below
- ▶ **Outside circle (OC)** — selects all entities fully outside of a circle

3D Selection

Both CAD systems offers sub-selection of 3D entities, such as faces and edges. Only BricsCAD, however, offers a visual version through the hotkey assistant, which appears automatically as soon as begin selecting:



Selecting whole entity, faces or edges

COMPARING DESIGNCENTER & DRAWING EXPLORER

BricsCAD's Drawing Explorer is best compared with AutoCAD's DesignCenter, but Explorer reports more information and provides greater control over drawing elements.

Drawing Explorer centralizes in BricsCAD what in AutoCAD amounts to as many separate dialog boxes. Facilities such as layer management, UCS control, and control of external references are in one location. (Autodesk appears to be copying BricsCAD by amalgamating similar commands, such as Attach.)

To access BricsCAD's Drawing Explorer, enter the **Explorer** command.

TIP BricsCAD displays Drawing Explorer automatically when you enter a related command, such as Style.

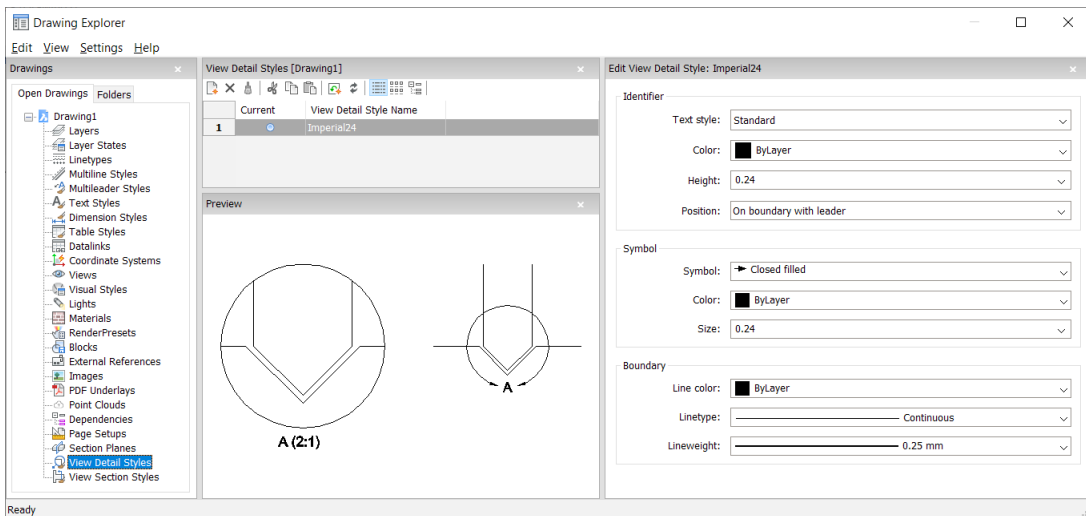

Drawing Explorer centralizes many named entities

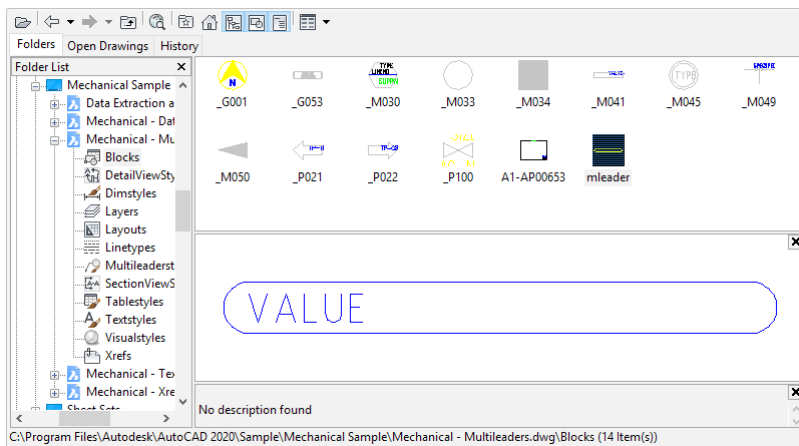

AutoCAD's Design Center

Drawing Explorer handles all named entities as listed in the table below.

AutoCAD DesignCenter	BricsCAD Drawing Explorer	Alternative Commands Used by AutoCAD
Blocks	Blocks	
...	24/7 (in Folders tab)	SaveToCloud command (Autodesk 360)
...	Coordinate Systems	UcsMan command
...	Datalinks	dbConnect palettes
...	Dependencies	eTransmit command
DetailViewStyles	View Detail Styles	
Dimstyles	Dimension Styles	
Xrefs	External References	
...	Images	ExternalReferences command
Layers	Layers	
...	Layer States	LayerStates command
...	Lights	LightList command
Linetypes	Linetypes	
Layouts	Page Setups	
...	Materials	MatBrowserOpen command
...	Multiline Styles	MISyle command
Multileaderstyles	Multileader Styles	
...	PDF Underlays	PDFAttach command
...	Point Clouds	PointCloudManager command
...	Render Presets	RenderPresets command
...	Section Planes	SectionPlaneSettings command
SectionViewStyles	View Section Styles	
Tablestyles	Table Styles	
Textstyles	Text Styles	
...	Views	View command
VisualStyles	Visual Styles	

BricsCAD includes settings for modifying these named entities, something lacking in AutoCAD's DesignCenter. For example, the Linetypes node lets you load additional linetypes, and the Dimension Styles node lets you modify the styles — as well as show differences between two styles.

Unified Interface

Drawing Explorer is more than a DesignCenter because it centrally gathers commands for inserting and controlling named entities. This is the same philosophy that drives Bricsys to make the Settings dialog box access all system variables, instead of just some of them.

By one count, the unified interface of BricsCAD's Drawing Explorer replaces the equivalent of 23 AutoCAD commands, related dialog boxes, and palettes.

COMPARING GIZMO AND MANIPULATOR

Editing in 3D is tricky business, and so both CAD programs provide a widget to more easily perform a few common editing operations on 3D parts. In AutoCAD, it is called the *gizmo*; in BricsCAD, the Manipulator.

The AutoCAD version suffers from two limitations. Whereas AutoCAD needs three gizmos to move, rotate, and scale, BricsCAD combines all these actions (and more!) into one. Whereas the AutoCAD version works only in a visual style (so not in 2D wireframe), the BricsCAD one always works.

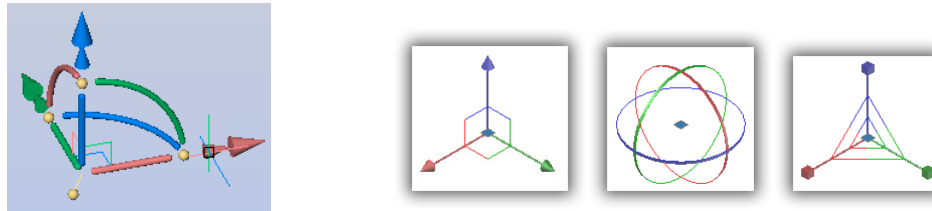

Left: Single Manipulator widget in BricsCAD; right: three gizmos in AutoCAD

The Manipulate command prompts you to select an entity, to which it attaches the manipulator widget. The widget rotates, moves, mirrors, and scales entities along the x, y, or z axes or xy, xz, or zy planes. Entity editing is performed by dragging the widget's arrowheads or bars, or else by entering values for precise control via dynamic dimensions. This command works on 2D and 3D entities.

- ▶ **Mirror** by dragging a blue arrowhead; this is the default action for arrowheads; to change it to scaling, right-click the widget and then choose the **Arrowhead Acts As** setting

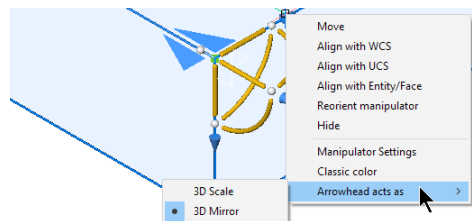

Accessing the shortcut menu

- ▶ **Scale** (resize) by dragging a blue arrowhead
- ▶ **Move** the selected entity by dragging one of the gold bars
- ▶ **Copy** by holding down the **Ctrl** key while dragging a bar
- ▶ **Rotate** by dragging one of the yellow arcs

You relocate the widget by dragging the white ball (found nearest to the origin), or else twist the widget by dragging one of the three white balls adjacent to each arrowhead. While changing the distance or angle, a ruler (or protractor) appears to guide your movement.

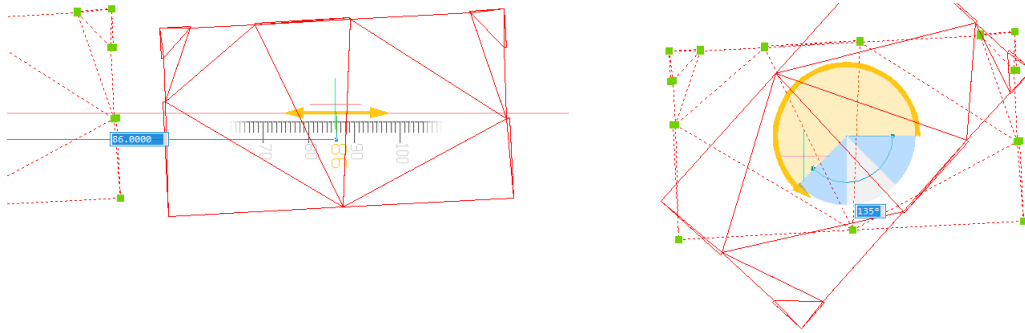

Left: Manipulator with ruler for distances; **right:** with protractor for angles

3D MODELING

See Chapter 6 for the differences between AutoCAD and BricsCAD in the area of 3D modeling.

COMPARING BRICSYS 24/7 AND AUTODESK 360

Bricsys 24/7 is the online collaboration and cloud storage from Bricsys. The equivalent in AutoCAD is A360, at time of writing. (Autodesk changes the names of its cloud products from time to time, and so it may be different by the time you read this.) Commands inside BricsCAD let you open and save files from and to the cloud.

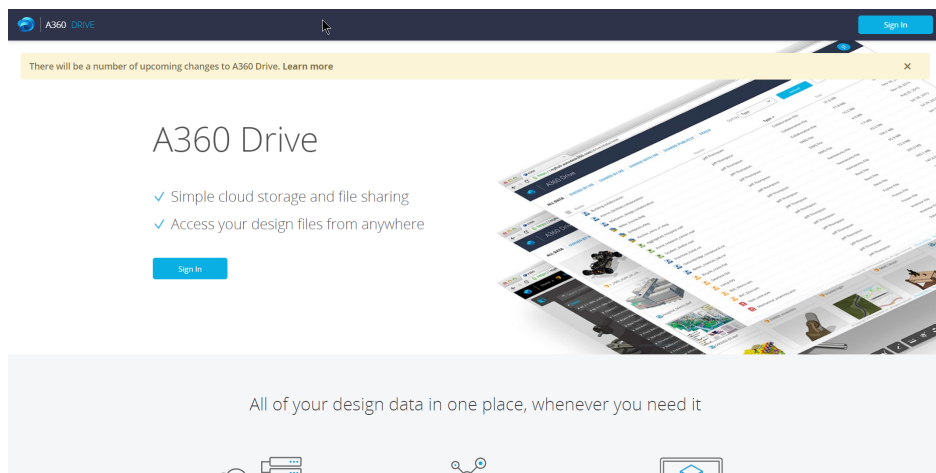

Above: Autodesk's Web page for A360; **below:** Bricsys Web page for 24/7

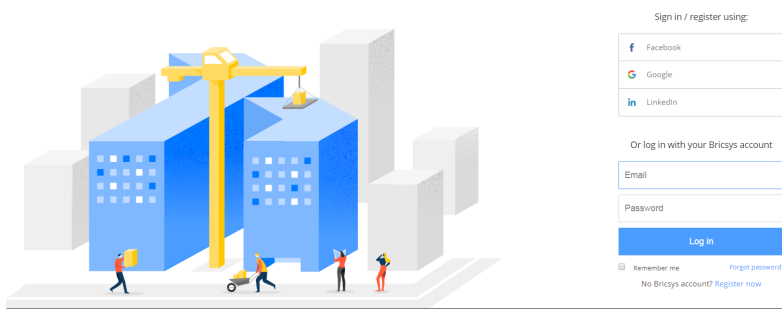

Within Bricsys 24/7, you create collaboration areas, which are helpful for project management. Bricsys 24/7 provides the following services:

- ▶ Project collaboration through project-specific email, forums, and data repositories
 - Version control through check-in/checkout
 - Calendar and address book for each project
 - Document management with sharing, viewing, and markups
 - Document viewing of 70+ file formats
- ▶ Project administration for assigning rights, folders, and so on
 - Access control assigned to managers, contractors, customers, supplies, and so on
 - Live data created from forms and data (optional add-on)
 - Graphical workflows created through a drag-and-drop editor

To sign up for the 30-day free version of 24/7, go to <https://www.bricsys.com/en-intl/247/>.

Using 24/7

You log into 24/7 at the Web site through the <https://my.bricsys247.com/openid/loginform.jsp> address, or else log in from inside BricCAD with the **CloudOpen** command.

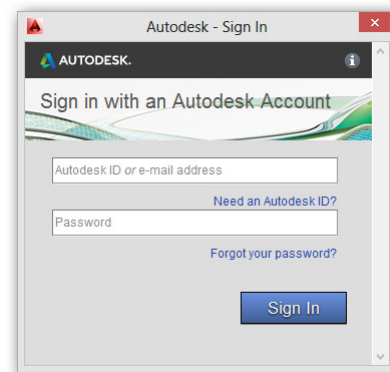
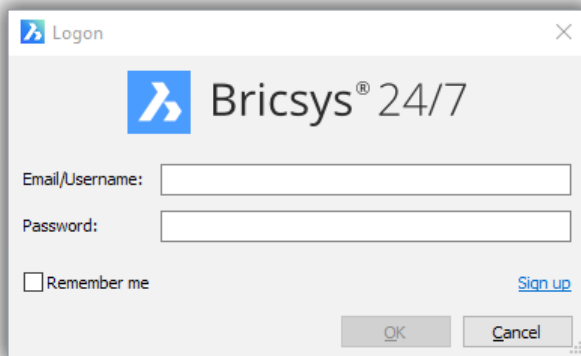

Left: Logging into 24/7 from BricCAD; **right:** Logging into A360 from AutoCAD

Commands in BricsCAD let you upload and download files:

CloudOpen opens files stored online

CloudDownload downloads files from online to your computer

CloudUpload uploads the current file to your online account, along with all dependent files, such as xrefs and image files, and optionally uploads fonts

CloudProject switches to the Web browser, and then opens your 24/7 account online

CloudLogoff logs out of your 24/7 account

With the connection made between your computer and 24/7, your files are made available in the 247 panel (see below) as well as through the Folders tab of Drawing Explorer.

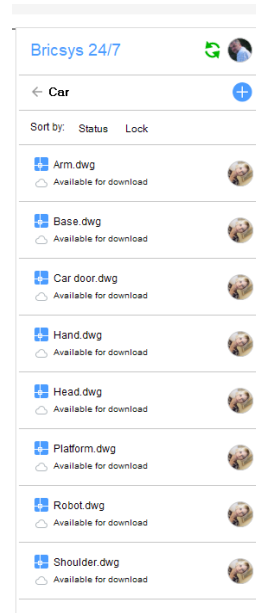

Accessing your folders on 24/7

— — —

THIS CHAPTER HIGHLIGHTED the differences in the user interface of BricsCAD and AutoCAD. Many of them are identical or similar, but some elements in BricsCAD are unique.

The next chapter examines how both programs display and edit entities in drawing files.

CHAPTER THREE

Compatibility of Drawing Elements

BRICSCAD READS AND WRITES AUTOCAD DRAWINGS VERY WELL, BUT IN A VERY FEW CASES not perfectly. This chapter details how well BricsCAD does at reading entities, properties, and styles created by AutoCAD.

For mixed-CAD offices or BricsCAD design firms working in a DWG world, it is important that the two CAD systems exchange drawings accurately. Use this chapter to assist you in pinpointing problem areas, should any occur.

The two CAD programs handle a large range of DWG and DXF versions, but BricsCAD is better than AutoCAD with older versions: it goes back to files created in 1987. Use the **Open** and **SaveAs** commands to access DWG and DXF files in the following versions:

Format	BricsCAD V20	AutoCAD 2020
Oldest DWG format opened	Release 12 (1993)	Release 14 (1997)
Oldest DXF format opened	Release 9 (1987)	Release 12 (1993)
Newest DWG/DXF format	Releases 2018-2020	Releases 2018-2020

In summary, BricsCAD reads and writes all the same DWG and DXF files as AutoCAD does, but goes further back in time. This is useful when working with archived drawings from projects initiated in the late 1980s and early 1990s.

TIP The version number of DWG2018 is version AC1032.

Entity Types

This chapter graphically illustrates the accuracy of BricsCAD's ability to read, display, and edit entities found in DWG2018 files. DWG2018 is the name of the format used by AutoCAD 2020 and BricsCAD V20. For the complete list, see the boxed text on the facing page.

There is more to handling the DWG format just displaying AutoCAD drawings accurately. BricsCAD must display entities that come in a variety of modes, such as different styles of points and formats of text. It must handle properties and entity tables correctly — which it does, for the most part — as described next.

Properties

The look of entities is controlled by *properties*, and so part of this chapter reports on the accuracy of BricsCAD's ability to read, display, and write the following entity and layer properties that can be found in DWG 2018 files:

- ▶ **Properties:** annotative scaling, colors (BYLAYER, BYBLOCK, ACI colors, and True Colors), elevations, hyperlinks, linetypes and linetype scales, lineweights, materials, plot styles, thicknesses, and transparencies
- ▶ **Layers:** status, name, on/off, freeze/thaw, lock/unlock, color, linetype, lineweight, transparency, plot style, plot, new viewport (VP), freeze new VP, VP freeze current VP, VP color, VP linetype, VP lineweight, VP transparency, and VP plot style description

Styles / Tables

Styles specify properties to specific entities by a single name. In the formal definition of the DWG/DXF format, styles are referred to as “tables,” even though they have nothing to do with the table entity. Part of this chapter describes how well BricsCAD handles the following DWG style/tables:

- ▶ Detail view styles & section view styles
- ▶ Dimension styles
- ▶ Multiline leader styles
- ▶ Mtext and text styles
- ▶ Multiline styles
- ▶ Plot styles
- ▶ Section styles
- ▶ Table styles
- ▶ Visual styles

CHECKLIST OF DWG2018 ENTITIES

The following checklist shows you the names all entities supported by DWG2018 (version AC1032), as listed by AutoCAD 2020. Not shown are entities specific to dynamic blocks.

- | | | |
|---|--|--|
| <input type="checkbox"/> 2D Polyline | <input type="checkbox"/> DGN Underlay | <input type="checkbox"/> Rotated Dimension |
| <input type="checkbox"/> 3 Point Angular Dime | <input type="checkbox"/> Diametric Dimension | <input type="checkbox"/> Section Object |
| <input type="checkbox"/> 3D Face | <input type="checkbox"/> DWF Underlay | <input type="checkbox"/> Shape |
| <input type="checkbox"/> 3D Polyline | <input type="checkbox"/> Ellipse | <input type="checkbox"/> Solid |
| <input type="checkbox"/> 3D Solid | <input type="checkbox"/> External Reference | <input type="checkbox"/> Spline |
| <input type="checkbox"/> Box | <input type="checkbox"/> Geomap Image | <input type="checkbox"/> Surface |
| <input type="checkbox"/> Cone | <input type="checkbox"/> Hatch | <input type="checkbox"/> Surface (Extrusion) |
| <input type="checkbox"/> Cylinder | <input type="checkbox"/> Helix | <input type="checkbox"/> Surface (Loft) |
| <input type="checkbox"/> Pyramid | <input type="checkbox"/> Horizontal Constraint Parameter | <input type="checkbox"/> Surface (NURBS) |
| <input type="checkbox"/> Sphere | <input type="checkbox"/> Jogged Dimension | <input type="checkbox"/> Surface (Planar) |
| <input type="checkbox"/> Torus | <input type="checkbox"/> Leader | <input type="checkbox"/> Surface (Revolve) |
| <input type="checkbox"/> Wedge | <input type="checkbox"/> Light | <input type="checkbox"/> Surface (Sweep) |
| <input type="checkbox"/> Extrusion | <input type="checkbox"/> Line | <input type="checkbox"/> Table |
| <input type="checkbox"/> Sweep | <input type="checkbox"/> Mesh | <input type="checkbox"/> Text |
| <input type="checkbox"/> Revolve | <input type="checkbox"/> MInsert Block | <input type="checkbox"/> Tolerance |
| <input type="checkbox"/> Loft | <input type="checkbox"/> MLine | <input type="checkbox"/> Trace |
| <input type="checkbox"/> ACADPROXY_ENTITY | <input type="checkbox"/> MText | <input type="checkbox"/> Vertical Constraint Parameter |
| <input type="checkbox"/> Aligned Dimension | <input type="checkbox"/> Multileader | <input type="checkbox"/> Viewport |
| <input type="checkbox"/> Angular Dimension | <input type="checkbox"/> OLE | <input type="checkbox"/> Wipeout |
| <input type="checkbox"/> Arc | <input type="checkbox"/> Ordinate Dimension | <input type="checkbox"/> XLine |
| <input type="checkbox"/> Arc Length Dimensio | <input type="checkbox"/> PDF Underlay | |
| <input type="checkbox"/> Array (Path) | <input type="checkbox"/> Point | |
| <input type="checkbox"/> Array (Polar) | <input type="checkbox"/> Polyface Mesh | |
| <input type="checkbox"/> Array (Rectangular) | <input type="checkbox"/> Polygon Mesh | |
| <input type="checkbox"/> Attribute | <input type="checkbox"/> Polyline | |
| <input type="checkbox"/> Attribute Definition | <input type="checkbox"/> Position Marker | |
| <input type="checkbox"/> Block Reference | <input type="checkbox"/> Radial Dimension | |
| <input type="checkbox"/> Body | <input type="checkbox"/> Radius Constraint Parameter | |
| <input type="checkbox"/> Camera | <input type="checkbox"/> Raster Image | |
| <input type="checkbox"/> Center Mark | <input type="checkbox"/> Ray | |
| <input type="checkbox"/> Centerline | <input type="checkbox"/> Region | |
| <input type="checkbox"/> Circle | | |

DWG 2018 Compatibility

With each release of BricsCAD, Bricsys adds supports more entities and properties created by AutoCAD. While BricsCAD displays all entities in drawings created by AutoCAD, it does not, however, necessarily create or edit all of them. Part of this chapter details the entities and properties that work fully and the few that might not.

HOW WE TEST ENTITY COMPATIBILITY

To test BricsCAD’s compatibility with AutoCAD’s entities, we employed the following procedure:

1. Draw entities in AutoCAD, and then saved them to a DWG file.
2. Open the DWG file in BricsCAD.
3. Examine each entity for the following characteristics:
 - ▶ **Translation** — did the entity even show up in BricsCAD?
 - ▶ **Visual Accuracy** — does the entity look the same in BricsCAD as in AutoCAD?
 - ▶ **Editability** — can BricsCAD edit the entity; and if so, how fully?
 - ▶ **Constructability** — does BricsCAD have a command for creating the entity?
4. We made a screen grab of each entity in AutoCAD and then following translation in BricsCAD. The before and after images are included in this chapter illustrate similarities and differences.
5. We made a record the limitations we found.

The results of the tests are presented on the following pages.

Decoding the Legend

In this chapter, we mark how well BricsCAD supports each AutoCAD entity by means of a legend:

Entity Name	READ / CREATE / EDIT
-------------	----------------------

The words in the legend have the following meaning.

- Entity Name** — name of the DWG entity we are reporting on
- READ** — BricsCAD read the entity from the DWG file, and displays it correctly
- CREATE** — BricsCAD creates the entity
- EDIT** — BricsCAD edits the entity

There are a few AutoCAD entities that BricsCAD does not handle 100% correctly. For instance, BricsCAD can read and display dynamic blocks, but it cannot create or edit dynamic blocks. In these cases, the chapter tags these kinds of entities with a read-edit legend that looks like this:

Dynamic Blocks	AutoCAD	BricsCAD *	READ / — / —
----------------	---------	------------	--------------

*) The footnote details the limitation

The dashes (—) in “*READ / — / —*” mean that BricsCAD cannot edit or create dynamic blocks, and so the words “*CREATE*” and “*EDIT*” are missing from the legend. The asterisk (*) provides additional information in the footnote on how BricsCAD handles the entity.

Summary of Problem Entities

Even though BricsCAD does a very good job handling DWG files, there are some AutoCAD entities that prove difficult for it. Here is our summary of how these entities work in BricsCAD.

Constraints

Here are the differences in constraints between AutoCAD and BricsCAD:

- ▶ Like AutoCAD, BricsCAD displays **geometric** constraints made in AutoCAD drawings.
- ▶ But **dimensional** constraints in AutoCAD drawings are not displayed by BricsCAD.

Bricsys developed its own constraints engine, while Autodesk licenses the D-Cubed constraint engine from Siemens Digital Industries Software.

Dimensions

Here are the differences in dimensions between AutoCAD and BricsCAD:

- ▶ Like AutoCAD, BricsCAD displays inspection dimensions made by AutoCAD’s **DimInspect** command.
- ▶ But BricsCAD cannot edit or create them.
- ▶ Like AutoCAD, BricsCAD displays and edits jogged dimensions made by AutoCAD’s **DimJogged** command. As well, BricsCAD supports the **DimJogAng** variable.
- ▶ But BricsCAD cannot create jogged dimensions.

Dynamic Blocks

Bricsys suggests that dynamic blocks can be simulated through the use of 2D and 3D constraints. BricsCAD has a simple block editor environment (accessed by the BEdit and BClose commands) that edits regular blocks but not dynamic blocks.

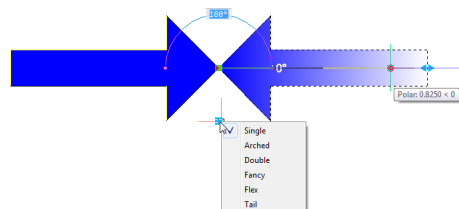

BricsCAD editing dynamic blocks through grips

- ▶ Like AutoCAD, BricsCAD displays and edits dynamic blocks made in AutoCAD’s Block Editor.

- ▶ BricsCAD is able to change the look of dynamic blocks through custom grips and the Properties palette, but it has no mechanism to change the visibility of components of dynamic blocks, an important function that is available in AutoCAD.
- ▶ But BricsCAD cannot create dynamic blocks.

Geographic Location

Here are the differences in geometric locations (world coordinates in longitude and latitude) between AutoCAD and BricsCAD:

- ▶ Like AutoCAD, BricsCAD can specify geographic locations in drawings with its **GeographicLocation** command.
- ▶ But BricsCAD cannot display, create, or edit marker glyphs that mark locations placed in AutoCAD.

Model Documentation

Here are the differences in model documentation (2D views generated from 3D drawings) between AutoCAD and BricsCAD:

- ▶ Like AutoCAD, BricsCAD displays model documentation created by AutoCAD's **ViewBase** command.
- ▶ But BricsCAD does not support AutoCAD's model documentation object enabler, and so bounding boxes display preview images of each view overlain with a message stating a missing object enabler is needed.

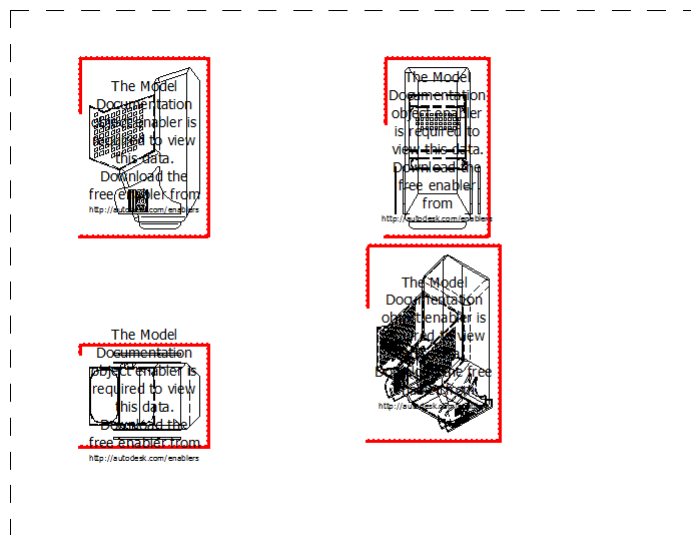

Message that appears when a DWG containing AutoCAD's model documentation is opened in BricsCAD

BricsCAD has its own form of model documentation called “view generation” that operates much like AutoCAD's by having many of the same commands. It creates 2D plans and isometric views of 3D models, with sections and detail views and styles.

Multilines

Here are the differences in multilines (multiple parallel line construction) between AutoCAD and BricsCAD:

- ▶ Like AutoCAD, BricsCAD reads and creates multilines and multiline styles made with AutoCAD's **MLine** and **MISStyle** commands. (BricsCAD's version of the MISStyle command opens the Drawing Explorer.)
- ▶ BricsCAD uses the same format for *.mln* multiline style files as AutoCAD, and so you can use the Drawing Explorer's **Load from MLN File** button to copy these files from AutoCAD.
- ▶ BricsCAD can edit some aspects of multilines with grips and the Properties bar's options.
- ▶ But BricsCAD lacks the **MIEdit** command and so intersections (vertices) cannot be fully edited.

Proxy Objects

Here are the differences in proxy objects (non-editible foreign entities) between AutoCAD and BricsCAD:

- ▶ Like AutoCAD, BricsCAD can display proxy objects, and in some cases it can edit them, because BricsCAD supports object enablers for AutoCAD Architecture, Mechanical Desktop, and Civil 3D.
- ▶ But for all other proxy objects, BricsCAD edits only basic properties, such as color, linetype, and so on through the Properties panel.

Sub-d Meshes

BricsCAD recognizes all other surfaces created by AutoCAD, including NURBS (non-uniform rational Bezier spline) and swept surfaces. However, there are differences in how BricsCAD handles sub-d meshes (easily editable 3D surfaces) made in AutoCAD:

- ▶ Like AutoCAD, BricsCAD opens and displays 3D sub-division (sub-d) mesh objects created by AutoCAD's commands like **Mesh** and **MeshSmooth**.
- ▶ But BricsCAD cannot create or manipulate them, except to edit meshes with only basic commands (such as Move, Copy, and Delete) and modify only basic properties, such as the color and linetype.

Note that sub-d meshes are "true" point-based 3D mesh objects introduced with AutoCAD 2010, and not the old style of meshes made from polyfaces. BricsCAD can create old-style polyface meshes with commands like **Ai_Box**. (Bricsys has indicated that sub-d meshes will be supported in the future.)

Tables

Here are the differences in tables (actual tables, with lines and text and stuff) between AutoCAD and BricsCAD:

- ▶ Like AutoCAD, BricsCAD reads, edits, and writes tables.
- ▶ But BricsCAD does not have all the table and cell format options found in AutoCAD; it cannot, for instance, give cells double lines.

For the complete list of BricsCAD's table style abilities, see the "Compatibility of Styles" section near the end of this chapter.

HISTORY OF BRICSCAD'S DWG SUPPORT

Here are some of the important features added with recent releases.

BRICSCAD V11

- › Modification of dynamic blocks through Properties panel
- › Fields
- › Partial support for geographic locations
- › Lights
- › PDF underlays

BRICSCAD V12

- › Dimensional and geometric constraints
- › Live sections
- › Tables

BRICSCAD V13

- › Multilines
- › Sheet sets
- › Tool palettes

BRICSCAD V14

- › Annotative properties for text entities, dimensions, and so on
- › Layer filters
- › Multiline leaders and styles
- › Section line entities
- › 2D and 3D helix entities
- › 3D solids made as swept entities and as sheet metal parts

BRICSCAD V15

- › Editing dynamic blocks and hatch patterns through grips
- › Polysolid entities
- › Formulae in tables

BRICSCAD V16

- › 3D solid lofts, 3D surface creation, editing, and deformations
- › Associative arrays
- › Detail styles and sections styles
- › Geomap images
- › Transparency property for entities and layers

BRICSCAD V17

- › AniPath for creating movies of 3D models
- › Extrude, Loft, Sweep, and Revolve create 3D surfaces from open objects
- › XEdges creates lines and arcs from the edges of 3D solids

Continued...

Underlays

Here are the differences in underlays (images placed in drawings) between AutoCAD and BricsCAD:

- › Like AutoCAD, BricsCAD displays DGN, PDF, and raster images as underlays, as well as externally-referenced drawing (xrefs) files. As well, it edits imported PDF files and point clouds.
- › But BricsCAD does not load or display DWF underlays.

Visual Styles

Here are the differences in visual styles between AutoCAD and BricsCAD:

- › BricsCAD reads, edits, and creates visual styles created by AutoCAD.
- › But BricsCAD cannot apply all of the properties that AutoCAD can, such as Intersection Edges, which are not yet implemented in BricsCAD.

BricsCAD provides a longer list of default visual styles than does AutoCAD. See the complete list in the “Compatibility between Styles” section near the end of this chapter.

MISCELLANEOUS COMPATIBILITY

Aspects of CAD programs are unaffected by DWG compatibility, yet are important to the end users:

- › Overall user experience, and the layout of workspaces
- › Additional commands and variables, or missing ones
- › Extra palettes, options, right-click options, and other UI elements, or missing ones
- › Methods of customization and programming

...continued

BRICSCAD V18

- › Drawing-compare of 2D and 3D drawings
- › Manipulate gizmo
- › Content Browser

BRICSCAD V19

- › Single Dim command
- › BEdit block editor
- › Attach point clouds, import DGN files, and convert PDF files to entities

BRICSCAD V20

- › Works with AutoCAD Civil entities and commands
- › Reads Autodesk ReCAP point cloud format

DWG2018 Entity Support in BricsCAD V20

To create, read, view, edit, and write DWG files, BricsCAD uses the Drawings SDK library from the Open Design Alliance. As the ODA adds support for more entities, Bricsys adds them to BricsCAD.

BricsCAD V20 supports DWG version AC1032 (a.k.a. DWG2018), which defines entities created in AutoCAD 2020 and by earlier releases.

TIP Autodesk added no new entities to AutoCAD 2020.

In this section, entities are listed in alphabetical order under the following section names:

- › 2D entities
- › Text entities
- › Dimension entities
- › Geometric and dimensional constraints
- › Complex 2D entities
- › 3D entities

Equivalent entities are illustrated from AutoCAD and BricsCAD, with entity grips shown.

2D ENTITIES

BricsCAD accurately displays, creates, and edits all of these 2D entities defined in AutoCAD:

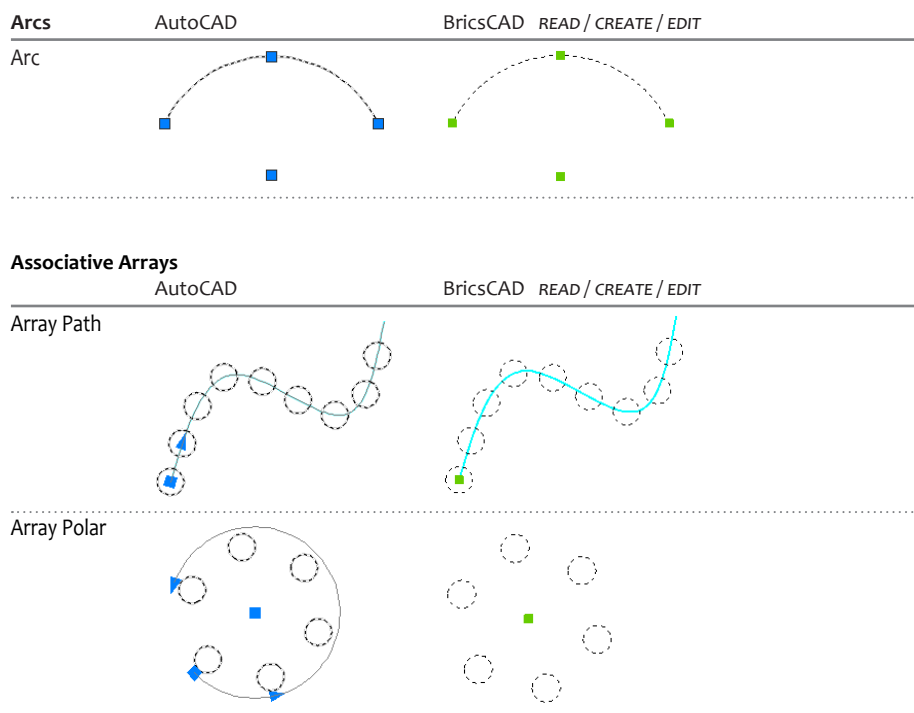

Array Rectangular

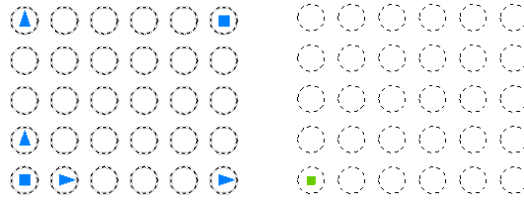

Associative Hatches

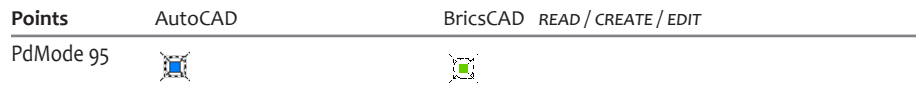
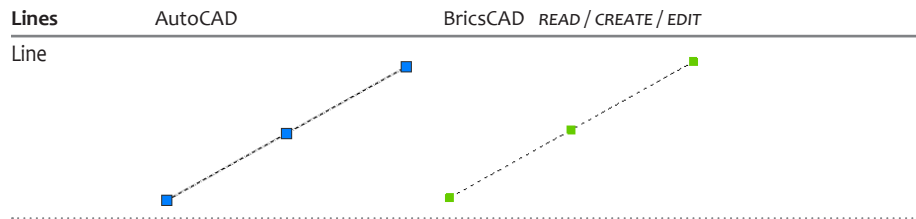
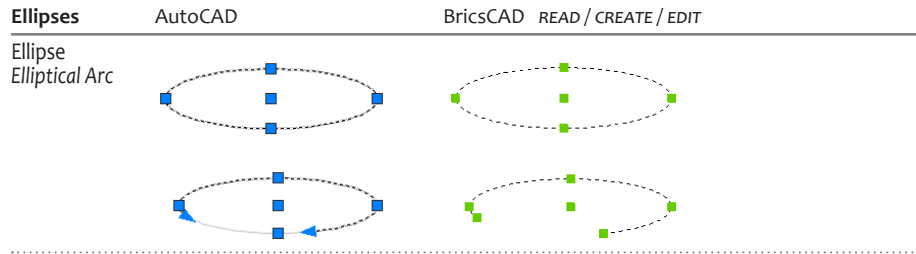
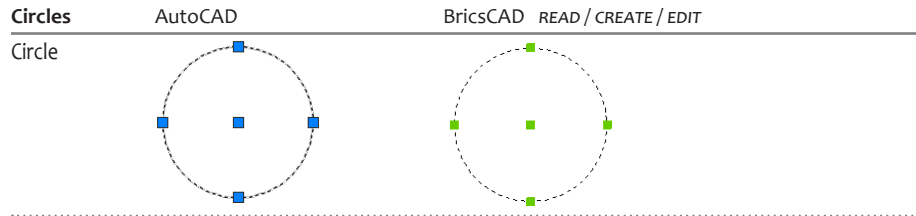
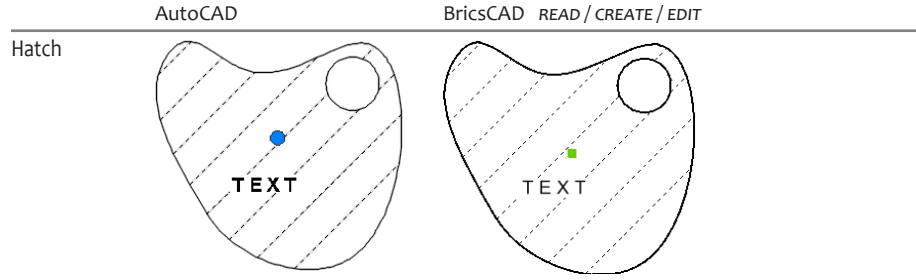

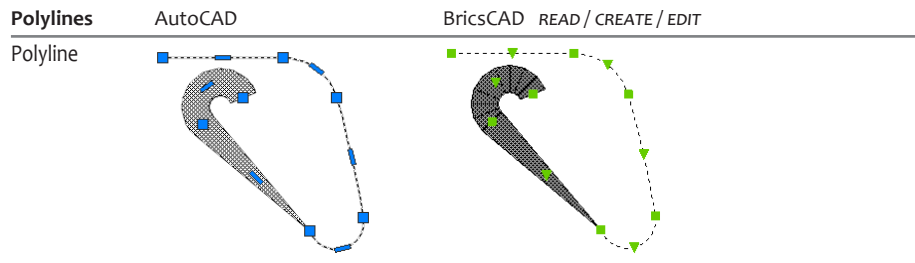

(*) Rays shown are cut off in this book, as real rays are infinitely long in one direction

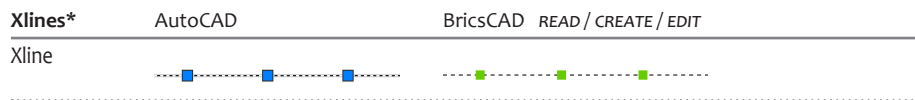
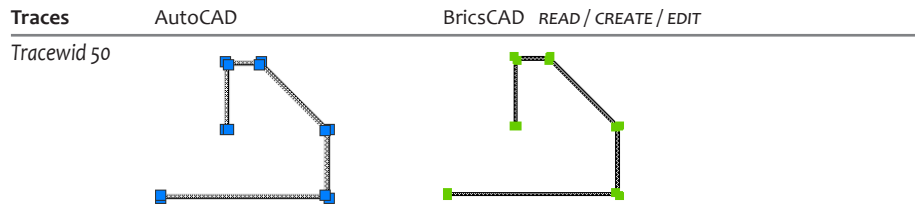
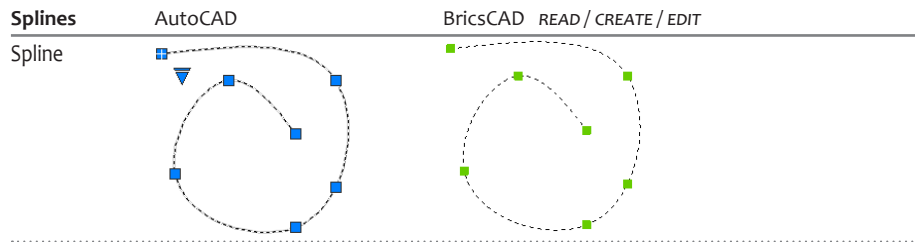
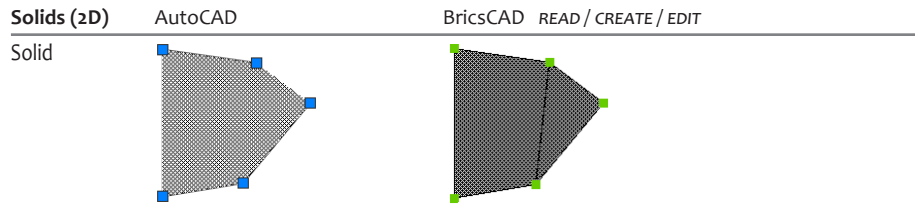



(*) Xlines shown are cut off in this book, as real xlines are infinitely long in both directions

TEXT ENTITIES



BricsCAD accurately displays, creates, and edit the following text entities defined by AutoCAD. Exceptions include certain types of formatting of mtext and tables, detailed later.

Attribute Definitions	AutoCAD	BricsCAD
Attribute Definition		

Attribute References	AutoCAD	BricsCAD
Attribute Reference		

MText	AutoCAD	BricsCAD
Mtext	<ul style="list-style-type: none"> ■ Applications: BricsCAD V10 is compiled with Visual Studio 2013 (platform toolset = v120). C++ extension dlls need to be compiled with the same platform toolset in order to be compatible. <ul style="list-style-type: none"> • To report problems, please send a Support Request. 	<ul style="list-style-type: none"> ■ Applications: BricsCAD V10 is compiled with Visual Studio 2013 (platform toolset = v120). C++ extension dlls need to be compiled with the same platform toolset in order to be compatible. <ul style="list-style-type: none"> • To report problems, please send a Support Request.

*) BricsCAD does not create all aspects of mtext; see “Compatibility of Styles” later in the chapter.

Text	AutoCAD	BricsCAD
Text		

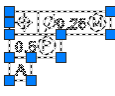
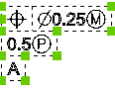
Tolerances	AutoCAD	BricsCAD
Tolerance		

DIMENSION ENTITIES

BricsCAD displays, creates, and edit all dimension entities defined by AutoCAD, except for some aspects of inspection and jogged dimensions.

Aligned	AutoCAD	BricsCAD	READ / CREATE / EDIT
Aligned Dimension			
Angular Dimension			
Arc Length Dimension			
Centermark			
Centerline			

Diameter	AutoCAD	BricsCAD	READ / CREATE / EDIT
----------	---------	----------	----------------------

Diametric Dimension

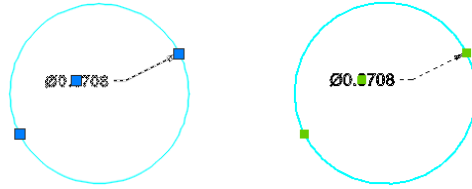

DimBreak	AutoCAD	BricsCAD	READ / CREATE / EDIT
----------	---------	----------	----------------------

Broken Dimension Line

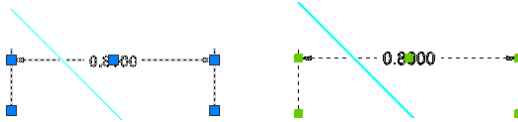

DimInspect	AutoCAD	BricsCAD	READ / —* / —*
------------	---------	----------	----------------

Inspection Dimension



*) BricsCAD displays inspection dimensions, but cannot create them or edit their content.

DimJogged	AutoCAD	BricsCAD	READ / —* / EDIT
-----------	---------	----------	------------------

Jogged Dimension

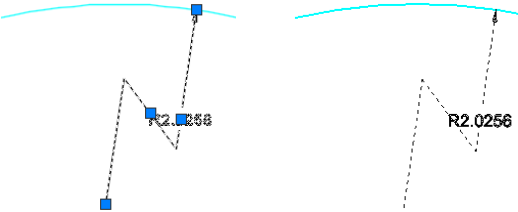

*) BricsCAD displays and edits jogged dimensions, but cannot create them.

Leaders	AutoCAD	BricsCAD	READ / CREATE / EDIT
---------	---------	----------	----------------------

Leader

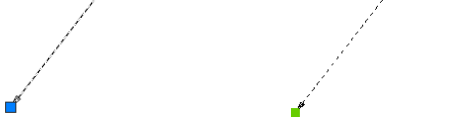

Multileaders	AutoCAD	BricsCAD	READ / CREATE / EDIT
--------------	---------	----------	----------------------

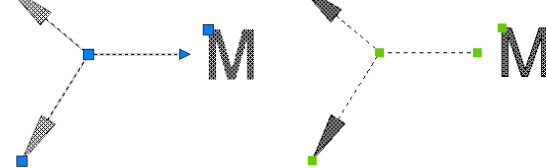

Multiline Leader

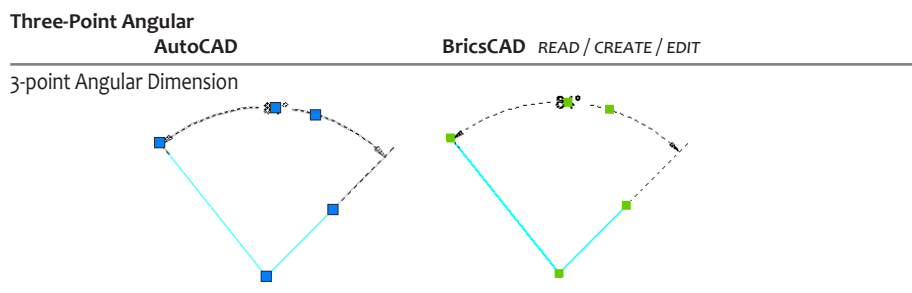
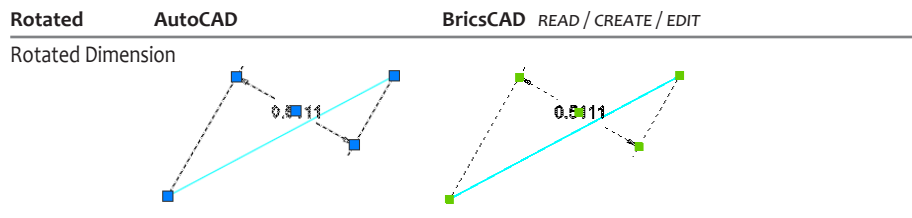
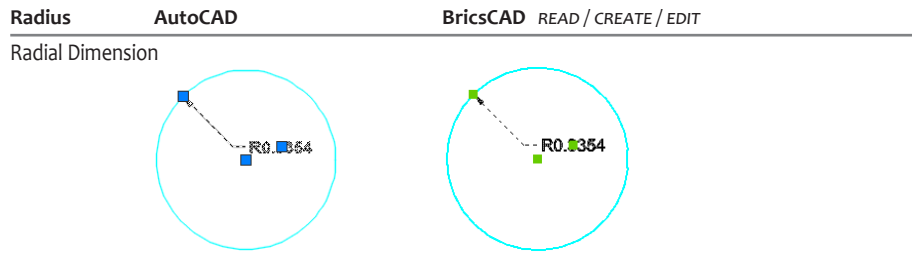
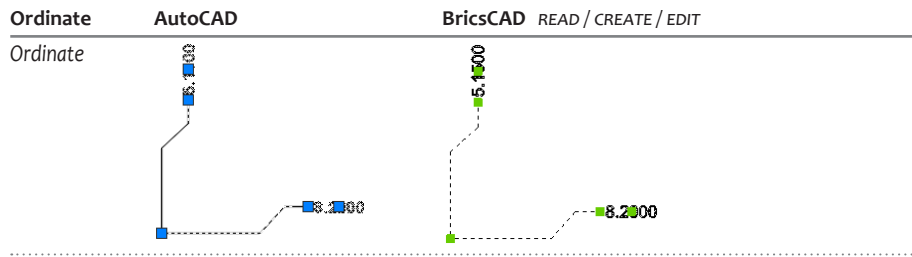

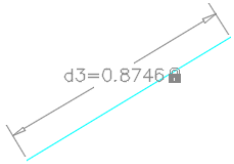
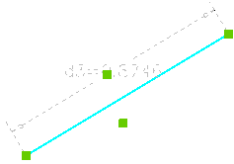
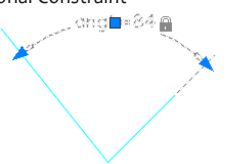
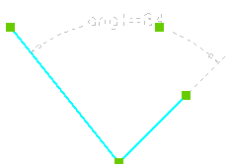
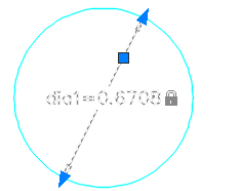
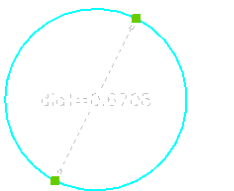
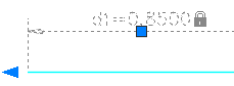

GEOMETRIC AND DIMENSIONAL CONSTRAINTS

BricsCAD has more types of constraints than AutoCAD; its constraints, however, are not compatible with AutoCAD.

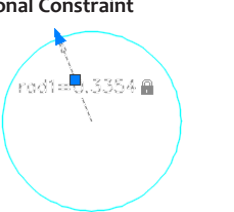
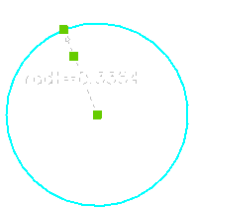
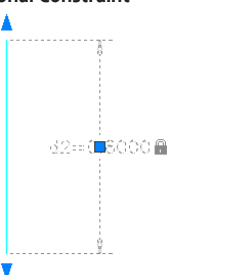
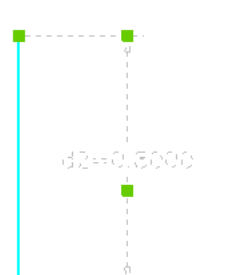
Dimensional Constraints	AutoCAD	BricsCAD	READ / CREATE / EDIT
Aligned Dimensional Constraint			
Angular Dimensional Constraint			
Diameter Dimensional Constraint			
Horizontal Dimensional Constraint			
Radius Dimensional Constraint			
Vertical Dimensional Constraint			

Geometric constraint

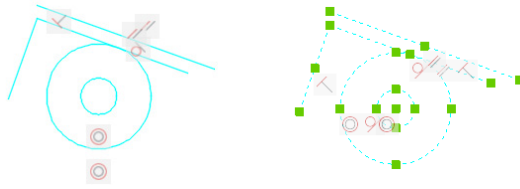

COMPLEX 2D ENTITIES

BricsCAD creates all the same complex 2D entities as AutoCAD, with the exceptions of dynamic blocks and DWF underlays.

Block References

AutoCAD

BricsCAD READ / CREATE / EDIT

Insert

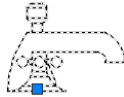

Faucet

Faucet

Dynamic *

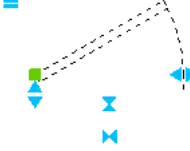
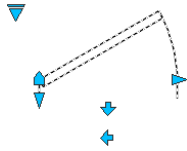

*) BricsCAD displays and edits dynamic blocks, but does not create them.

MInsert

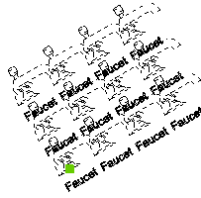
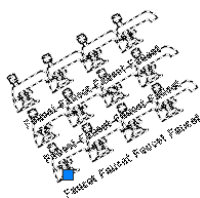



Lights

AutoCAD

BricsCAD READ / CREATE / EDIT

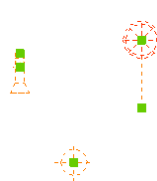
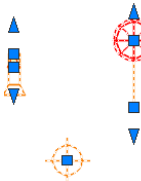
Light

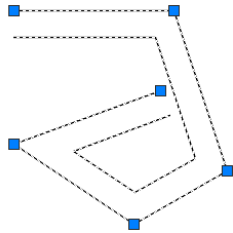
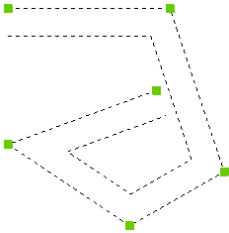
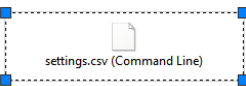
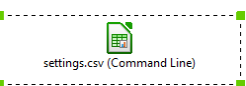
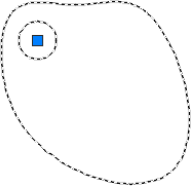
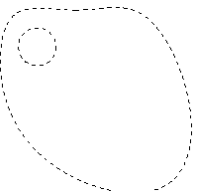
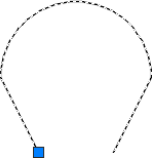
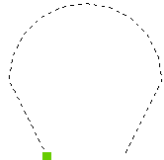

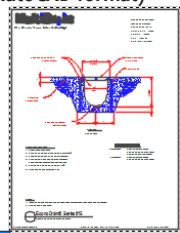
Multilines	AutoCAD	BricsCAD READ / CREATE / EDIT
Mline		
OLE Frames	AutoCAD	BricsCAD READ / CREATE / EDIT
Ole		
Regions	AutoCAD	BricsCAD READ / CREATE / EDIT
Region		
Shapes	AutoCAD	BricsCAD READ / CREATE / EDIT
Shape		
Underlays	AutoCAD	BricsCAD PARTIAL READ* / CREATE / EDIT
DGN Underlay (Microstation format)		
	*) BricsCAD does not display DGN underlays, but it does import DGN files as entities.	
DWF Underlay (AutoCAD format)		
	*) BricsCAD does not display DWF underlays, nor does it import them	

PDF Underlay (Adobe)

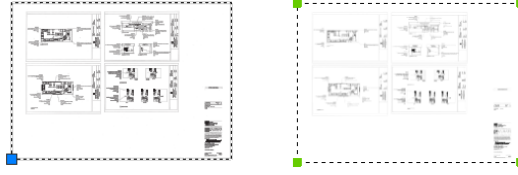

*) BricsCAD displays PDF files as underlays, and imports them as entities

Viewports AutoCAD

BricsCAD READ / CREATE / EDIT

Viewport

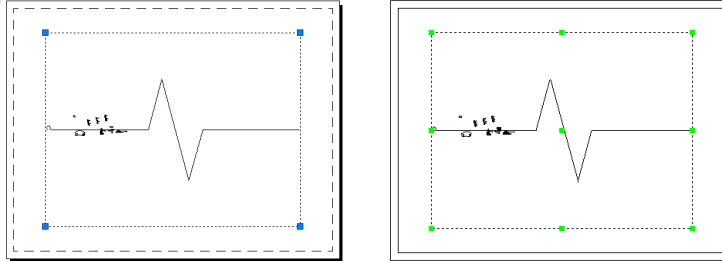

3D ENTITIES

BricsCAD accurately displays the following 3D entities created in AutoCAD:

3D Faces

AutoCAD

BricsCAD READ / CREATE / EDIT

3D face

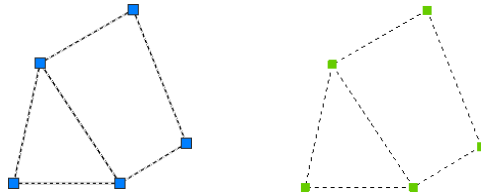

3D Polylines

AutoCAD

BricsCAD READ / CREATE / EDIT

3D polyline

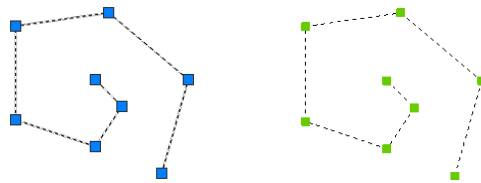

Helices

AutoCAD

BricsCAD READ / CREATE / EDIT

Helix

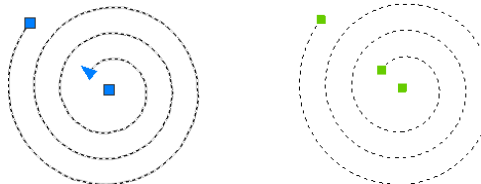

Polyface Meshes AutoCAD

BricsCAD READ / CREATE / EDIT

Polyface Mesh

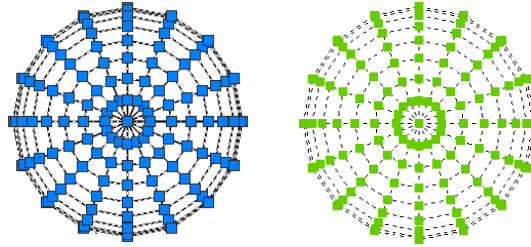

Polygon Meshes AutoCAD

BricsCAD READ / CREATE / EDIT

Polygon Mesh

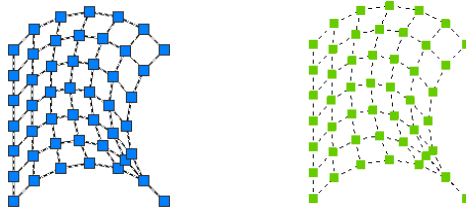

Sections

AutoCAD

BricsCAD

READ / CREATE / EDIT

Section Line

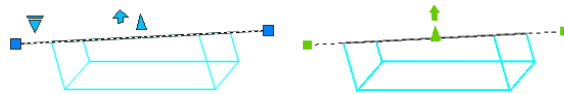

Section Object

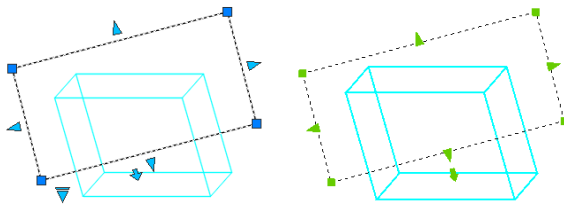

3D Solids

AutoCAD

BricsCAD

READ / CREATE / PARTIAL EDIT*

Box

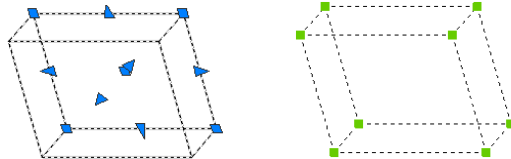

*) BricsCAD cannot edit 3D solids using grips; its grips only move solids.

Cone

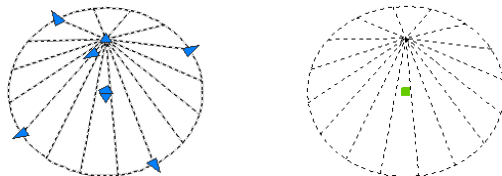

Cylinder

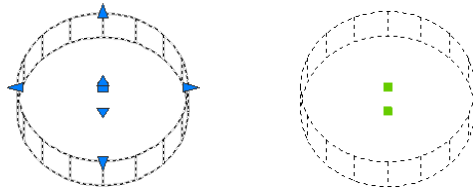

Extrusion

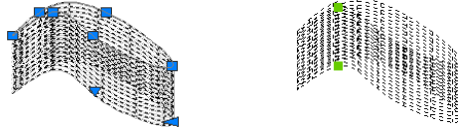

Loft

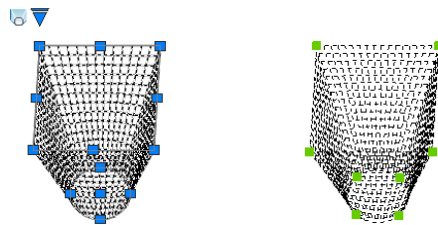

Pyramid

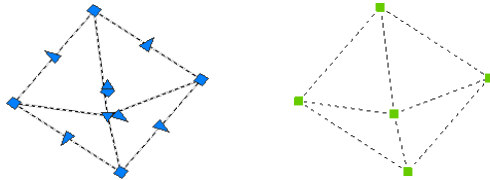

Revolve

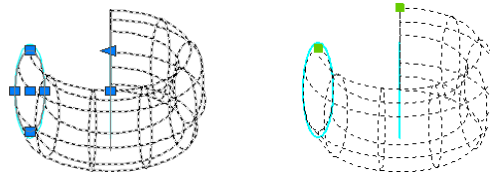

Sphere

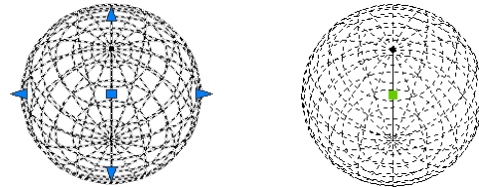

Sweep

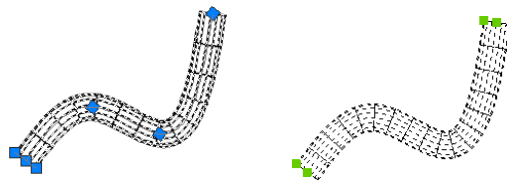

Torus

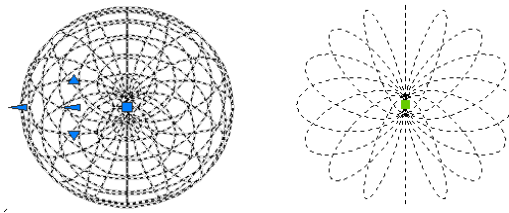

Wedge

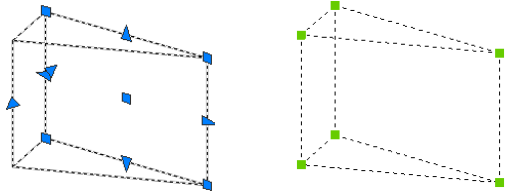

Point Clouds AutoCAD

BricsCAD READ / CREATE / EDIT

Pointcloud

BricsCAD attaches points clouds using its own format.

(new in V2o) BricsCAD reads Autodesk's ReCap point cloud file format

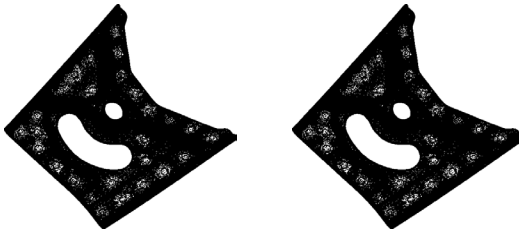

Subdivisions AutoCAD

BricsCAD READ / —* / —*

Mesh

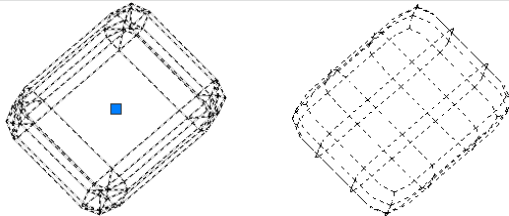

*) BricsCAD recognizes sub-division mesh objects created by AutoCAD, but cannot create or manipulate them, except for basic editing commands, such as Move, Copy, and Delete, and making property changes, such as color and linetype.

Surfaces AutoCAD

BricsCAD READ / CREATE / PARTIAL EDIT*

Extrusion

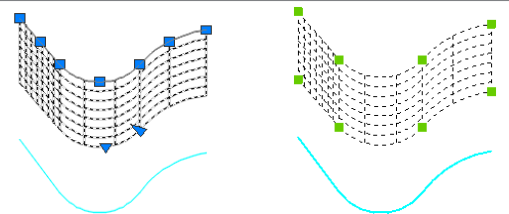

*) BricsCAD cannot edit 3D surfaces using grips; its grips only move surfaces.

Loft

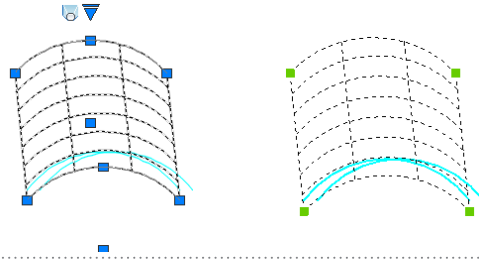

NURBS



Planar

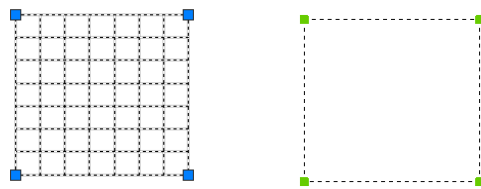

Revolve

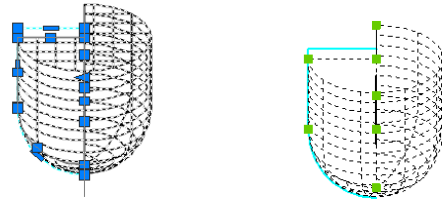

Sweep

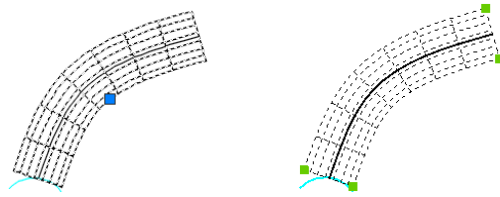

Compatibility Between Properties

BricsCAD supports nearly all of the entity properties found AutoCAD, including the all-important BYLAYER and BYBLOCK settings.

AutoCAD Property	BricsCAD Property	Notes
Annotative	Annotative	
Color	Color	BricsCAD supports ACI colors and True Colors, but not color books
Elevation	Elevation	
Hyperlink	Hyperlink	
Layer	Layer	BricsCAD supports all layer names and properties
Linetype	Linetype	BricsCAD supports all AutoCAD linetypes, and reads .lin files
Linetype scale	Linetype Scale	
Lineweight	Lineweight	BricsCAD supports all lineweight styles
Material	Material	BricsCAD has its own materials library
Plot Style	Plot Style	BricsCAD supports AutoCAD plot styles, reads .ctb and .stb files
Shadow display	...	BricsCAD does not support the shadow property
Thickness	Thickness	
Transparency	Transparency	

LAYER PROPERTY COMPATIBILITY

BricsCAD supports all of the basic properties of AutoCAD's layering system. For instance, DWG files can contain an unlimited number of layers, with names up to 255 characters long, including special characters.

BricsCAD supports layer states and filters, like AutoCAD; on the other hand, BricsCAD supports the Material property in directly layers, whereas AutoCAD does only indirectly.

AutoCAD Command	BricsCAD Command	Comment
Layer	LayerPanelOpen	Opens the Layer panel (palette)
LayerClose	LayerPanelClose	Closes the Layer panel
ClassicLayer	Layer	Opens the Layer dialog box
LayerState	LayerState	AutoCAD opens the Layer States Manager dialog box BricsCAD opens the Drawing Explorer
LayerP	LayerP	

The figures below illustrate the layer properties in the two CAD systems:

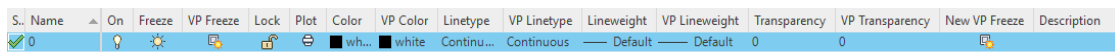

Above: Layer properties in AutoCAD (paper space)

Below: Layer properties in BricsCAD (paper space)

Current	Layer Name	Description	On/Off	Freeze	Locked	Color	Linetype	Lineweight	Transparency	Plot Style	Plot	New VP	VP Freeze	VP Color	VP Linetype	VP Lineweight	VP Transparency	VP Plot Style	Material
0	Defpoints		On	Freeze	Lock	White	Continuous	0	1.00 mm	Color 7	Plot	VP Freeze	VP Freeze	White	Continuous	1.00 mm	0	Color 7	Global

The minor differences in layer properties are listed concisely by the following table:

AutoCAD Layer Property	BricsCAD Equivalent Property	Notes
Status	Current	BricsCAD supports two statuses: current and not current
Name	Layer Name	BricsCAD supports all AutoCAD forms of layer names
On	On/Off	
Freeze	Freeze	
Lock	Locked	
Color	Color	BricsCAD supports all AutoCAD colors, but not ColorBooks
Linetype	Linetype	BricsCAD supports all AutoCAD linetypes, and the .lin file
Lineweight	Lineweight	
Transparency	Transparency	
Plot Style	Plot Style	BricsCAD supports AutoCAD plot styles formats, .ctb and .stb files
Plot	Plot	
Description	Description	
New VP Freeze	New VP	
...	Material	BricsCAD assigns materials to 3D objects though layers

Layer Settings for Layouts

VP Freeze	VP Freeze
VP Color	VP Color
VP Linetype	VP Linetype
VP Lineweight	VP Lineweight
VP Transparency	VP Transparency
VP Plot Style	VP Plot Style

Layer States. AutoCAD defines and controls layer states through a dialog box accessed from its Layers palette; BricsCAD does so though its ubiquitous Drawing Explorer.

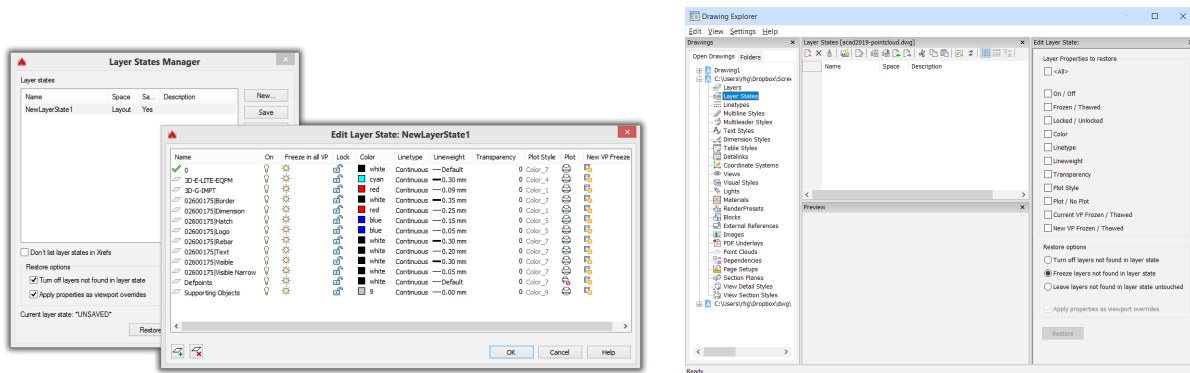

Left: Layer States Manager dialog boxes in AutoCAD
Right: Layer States in BricsCAD's Drawing Explorer

Compatibility Between Styles

BricsCAD supports nearly all styles found in AutoCAD.

AutoCAD Style	BricsCAD Style	Notes
Detail view styles	Detail view styles	
Dimension styles	Dimension styles	
Leader, QLeader	DimLeader, QLeader	
Multiline styles	Multiline styles	BricsCAD supports all aspects of multilines, except editing intersections
Multileader styles	Multileader styles	
Plot styles	Plot styles	
Section view styles	Section view styles	
Section styles	Section Planes	
Table styles	Table styles	BricsCAD supports most properties of table styles, incl. annotative scaling
Text styles	Text styles	BricsCAD supports most properties of text styles, including annotative scaling
Visual styles	Visual styles	BricsCAD supports most properties of visual styles

The following sections describe style compatibility in greater detail.

View Detail and Section Styles

Detail and section view styles are part of AutoCAD’s model documentation. In BricsCAD, this is known as “drawing views” (formerly called as “generative drafting”). *Model documentation* and *drawing views* are the CAD system’s ability to make traditional 2D views — front, top, isometric, details, cross-sections, and so on — from 3D models semi-automatically.

In AutoCAD, model documentation is sourced from AutoCAD or Inventor; BricsCAD is sourced from BricsCAD. Both CAD systems also work with models imported from other MCAD systems, such as Solidworks and Pro/Engineer.

AutoCAD Commands	BricsCAD Commands
ViewDetailStyle	ViewDetailStyle
ViewSectionStyle	ViewSectionStyle

BricsCAD does not support as many style aspects as does AutoCAD. The following properties are missing:

- › Arrangement
- › Model edge
- › Connection line
- › View label (except for position)

Here is the dialog box displayed by AutoCAD and the Drawing Explorer displayed by BricsCAD for the **ViewDetailStyle** command:

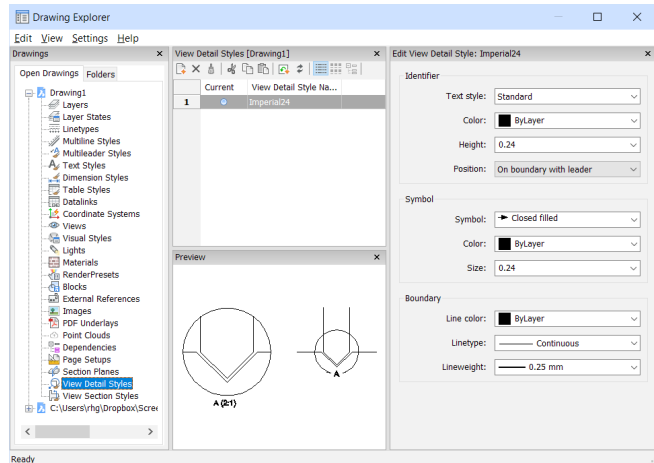
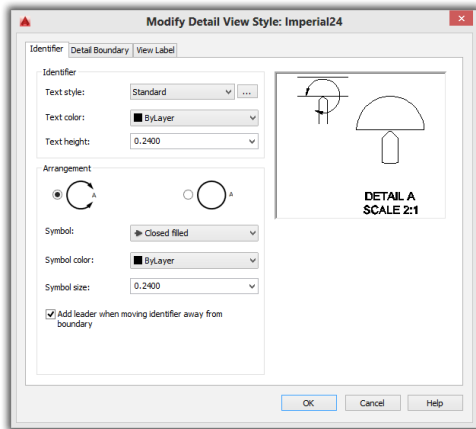

Left: AutoCAD's tabbed Modify Detail View Style dialog box; **right:** BricsCAD's Modify Detail View Style section in the Drawing Explorer

BricsCAD and AutoCAD support a different set of properties. AutoCAD offers these additional properties:

- ▶ Exclude characters
- ▶ Hatch background colors
- ▶ Show hatching toggle
- ▶ Hatch transparency
- ▶ View label properties

Here is the dialog box displayed by AutoCAD and the Drawing Explorer displayed by BricsCAD for the **ViewSectionStyle** command:

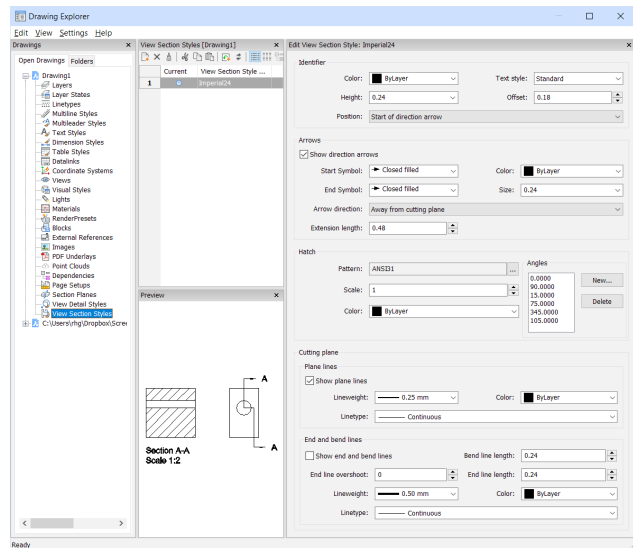
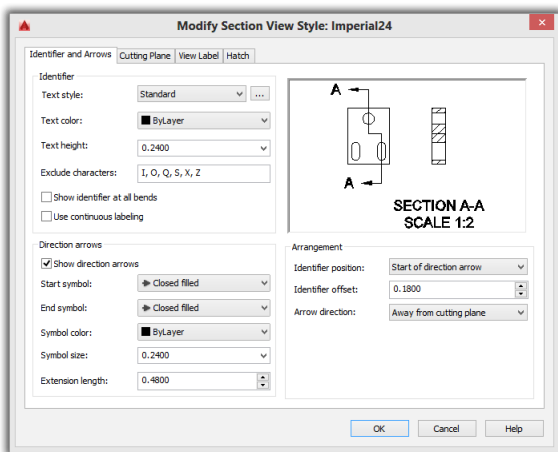

Left: AutoCAD's tabbed Modify Section View Style dialog box; **right:** BricsCAD's version in the Drawing Explorer

Dimension Styles

BricsCAD supports all properties of AutoCAD's dimension styles and variables.

AutoCAD Command	BricsCAD Command
DimStyle	DimStyle

In BricsCAD, the **DimStyle** command brings up the Drawing Explorer:

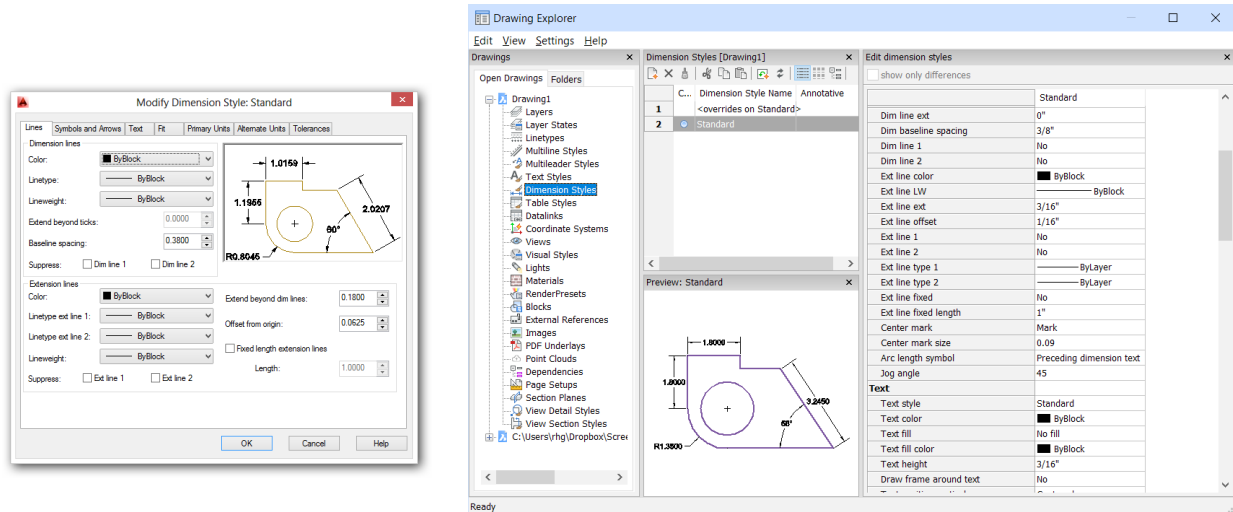

Left: AutoCAD's DimStyle tabbed dialog box; right: BricsCAD's Drawing Explorer for dimensions styles

TIP The BricsCAD version of the DimStyle command includes the **Show Only Differences** toggle. Select two dimensions style names by holding down the **Shift** or **Ctrl** keys.

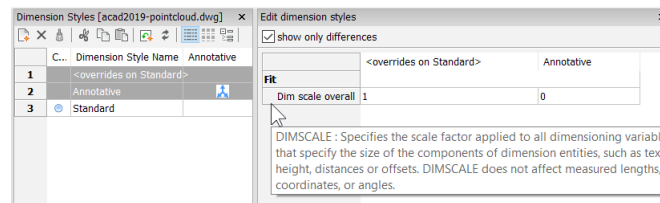

Leader and QLeader Styles

BricsCAD supports styles for leaders drawn by the DimLeader or QLeader commands. Styles are edited by the DimStyle command, just like AutoCAD.

AutoCAD Commands	BricsCAD Commands
Leader, DimStyle	DimLeader, DimStyle
QLeader, QLeader Setting	QLeader, QLeader Setting

Unlike most other styles that use the Drawing Explorer, the options for QLeader in BricsCAD are accessed through a dialog box via the **QLeader** command's **Settings** option.

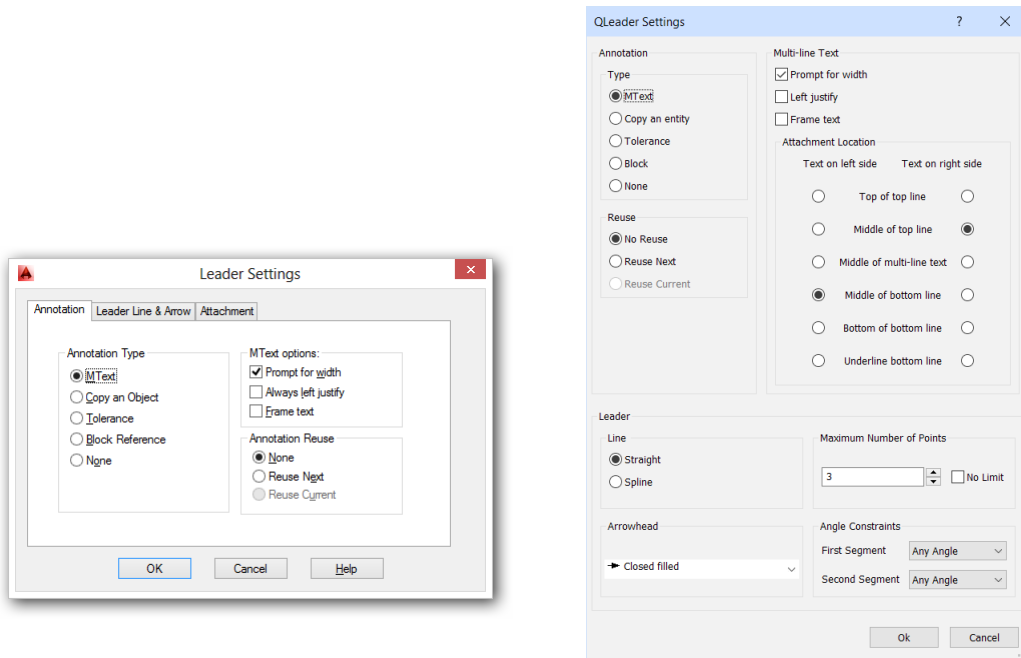

Left: AutoCAD's QLeader command's Settings dialog box; **right:** BricsCAD's QLeader command's options.

BricsCAD supports all the QLeader options found in AutoCAD.

MText and Text Styles

BricsCAD supports all of AutoCAD's text style options. BricsCAD uses an icon for annotative text styles that looks somewhat different from AutoCAD's:



Left: Annotation icon used by AutoCAD; **right:** As employed by BricsCAD

AutoCAD Command	BricsCAD Command
Style	Style
MText	MText

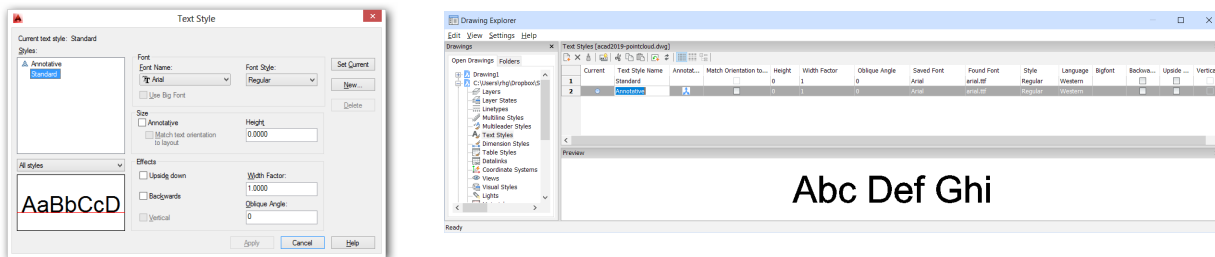

Left: AutoCAD's Style dialog box; **right:** BricsCAD's Drawing Explorer for text styles.

The MText ribbon and toolbar for both CAD systems are shown below.

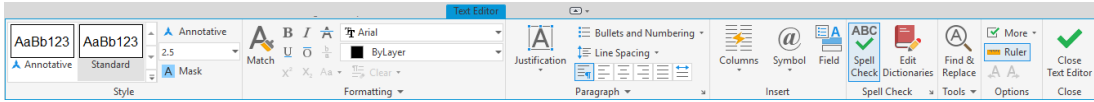

Above: AutoCAD edit mtext through the ribbon; **below:** BricsCAD edits mtext through a toolbar

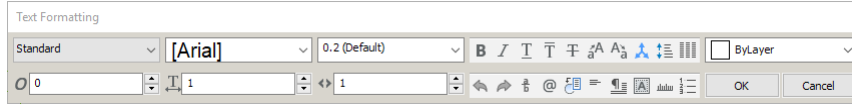

BricsCAD supports most of AutoCAD's mtext options, including mtext's ability to override styles.

AutoCAD Mtext Function	BricsCAD Mtext Function
Style	Style
Font	Font
Annotative	Annotative
Height	Height
Boldface	Boldface
Italicized	Italicized
Underline	Underline
Overline	Overline
Undo	Undo
Redo	Redo
Fractions	Fractions
Color	Color
Ruler Toggle	Ruler Toggle
Dynamic or Static Columns	Dynamic or Static Columns
Column Properties	Column Properties
Text Justification	Text Justification
Paragraph Properties	(new in v20) Paragraph Spacing
Paragraph Justification	Paragraph Justification
Line Spacing	Line Spacing
Bullets and Numbering	Bullets and Numbering
Field Text	Field Text
Case Conversion	Case Conversion
Special Characters	Special Characters
Obliquing Angle	Obliquing Angle
Tracking	Tracking
Width Factor	Width Factor
Import Text	(Use PasteSpec command)
Find and Replace	(Use the Find command)
AutoCAPS	...
Character Set	...
Combine Paragraphs	...
Remove Formatting	...
Background Mask	Background Mask
Editor Settings	(Use Settings command)

Multiline Styles

BricsCAD creates multi-lines through the **MLine** command and specifies their styles through the **MISyle** command, which brings up the Drawing Explorer.

AutoCAD Command	BricsCAD Command
MISyle	MISyle

BricsCAD supports all properties found in AutoCAD's multiline styles, but does not have AutoCAD's MIEdit command for editing intersections.

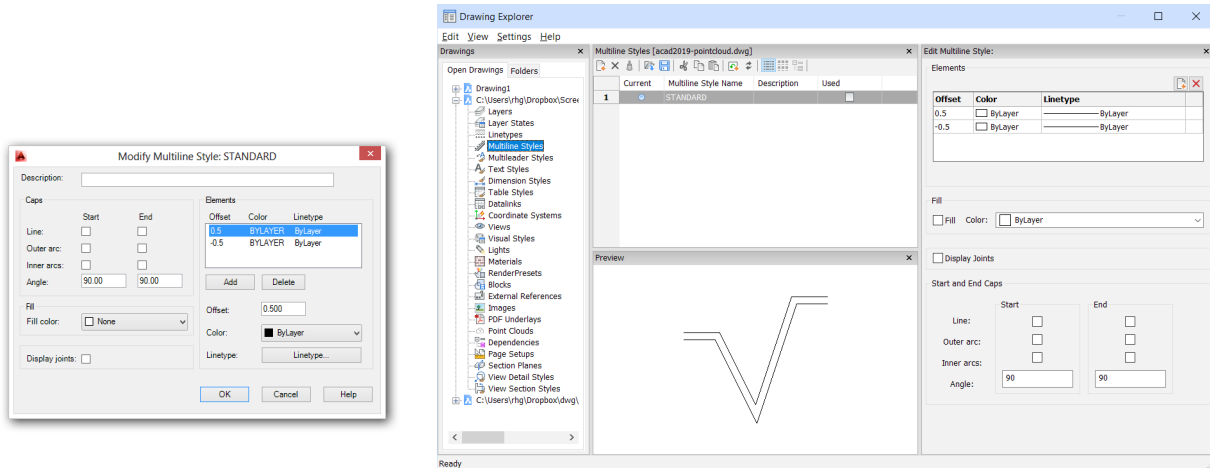

Left: AutoCAD's multiline style editor; right BricsCAD's multiline style editor in Drawing Explorer

Multileader Styles

BricsCAD creates leaders with multiple lines through the **MLeader** command and specifies their styles through the **MleaderStyle** command, which brings up the Drawing Explorer.

AutoCAD Command	BricsCAD Command
MleaderStyle	MleaderStyle

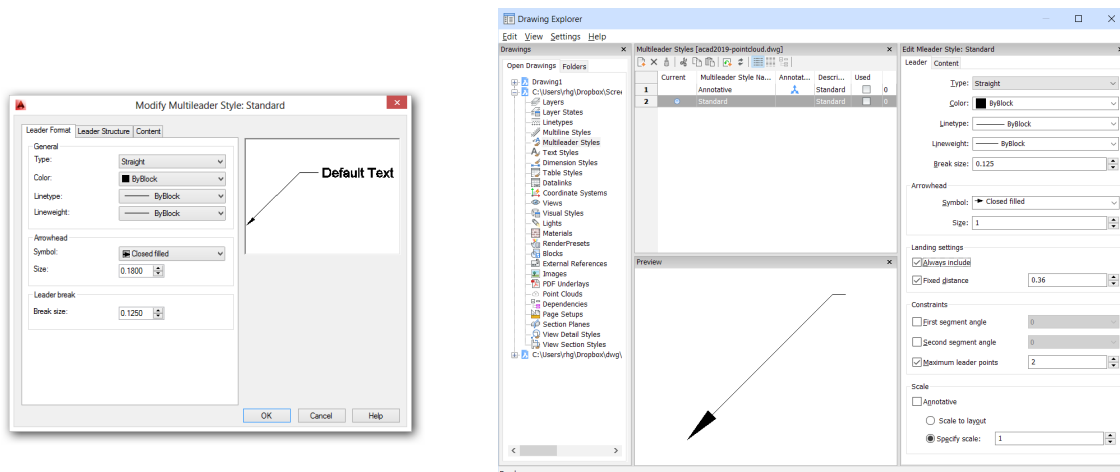

Left: AutoCAD's multileader style editor; right BricsCAD's multileader style editor in Drawing Explorer

BricsCAD supports all properties found in AutoCAD's multileader style dialog box, except that it lacks the callout blocks included with AutoCAD.

Plot Styles

BricsCAD supports both types of AutoCAD plot styles, color and table-based. They are created and edited with the same commands as in AutoCAD.

AutoCAD Command	BricsCAD Command
PlotStyle	PlotStyle
StylesManager	StylesManager
PlotterManager	PlotterManager
PageSetup	PageSetup

The properties supported for plot styles are identical in both CAD systems — color-based styles stored in *.ctb* files; table-based styles stored in *.stb* files.

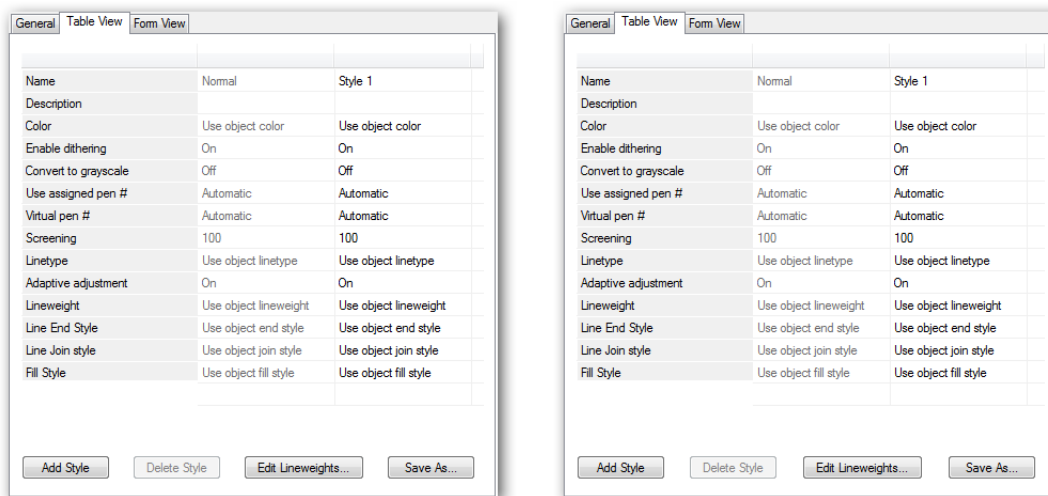

Left: Plot style properties in AutoCAD... ; right: ...and in BricsCAD.

Section Styles

AutoCAD and BricsCAD draw and edit 2D, 3D, and live sections of 3D models. Section properties are created and edited with the same command in AutoCAD and BricsCAD:

AutoCAD Command	BricsCAD Command
SectionPlaneSettings	SectionPlaneSettings

BricsCAD supports all of the section plane properties found in AutoCAD.

TIP Before a section plane style can be edited, the drawing must contain at least one section plane, which is drawn with the **SectionPlane** command.

Section styles are created and modified in BricsCAD by the Drawing Explorer.

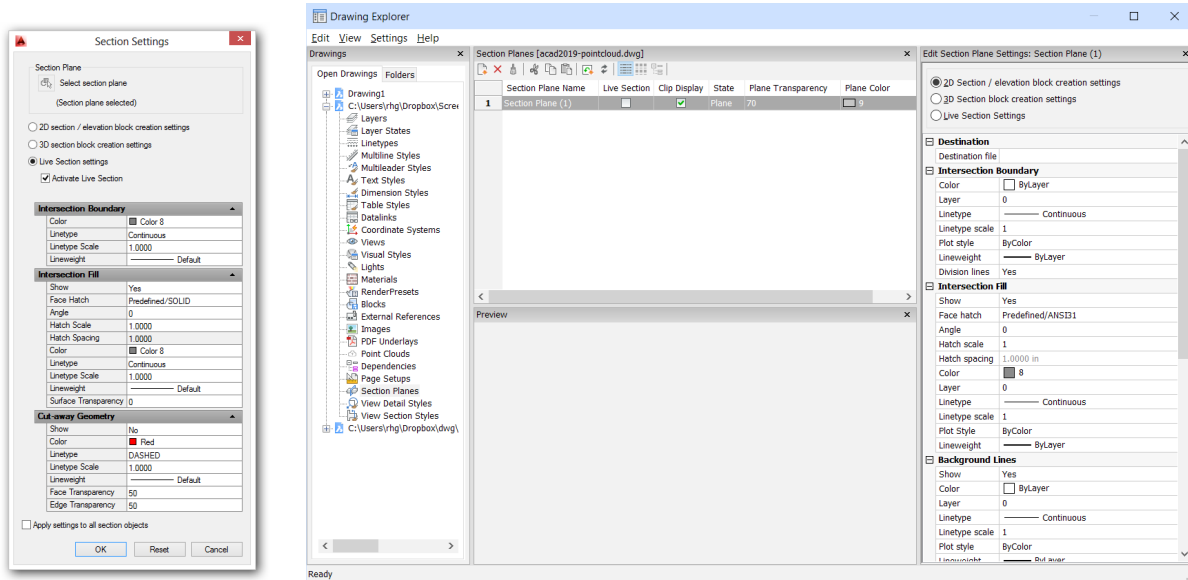

Left: Section Settings palette in AutoCAD; right: Section Planes settings in BricsCAD's Drawing Explorer

Table Styles

BricsCAD creates and edit table styles with the **TableStyle** command, as in AutoCAD. Unlike AutoCAD, BricsCAD's TableStyle command calls up the Table Style section of the ubiquitous Drawing Explorer.

AutoCAD Command

BricsCAD Command

TableStyle

TableStyle

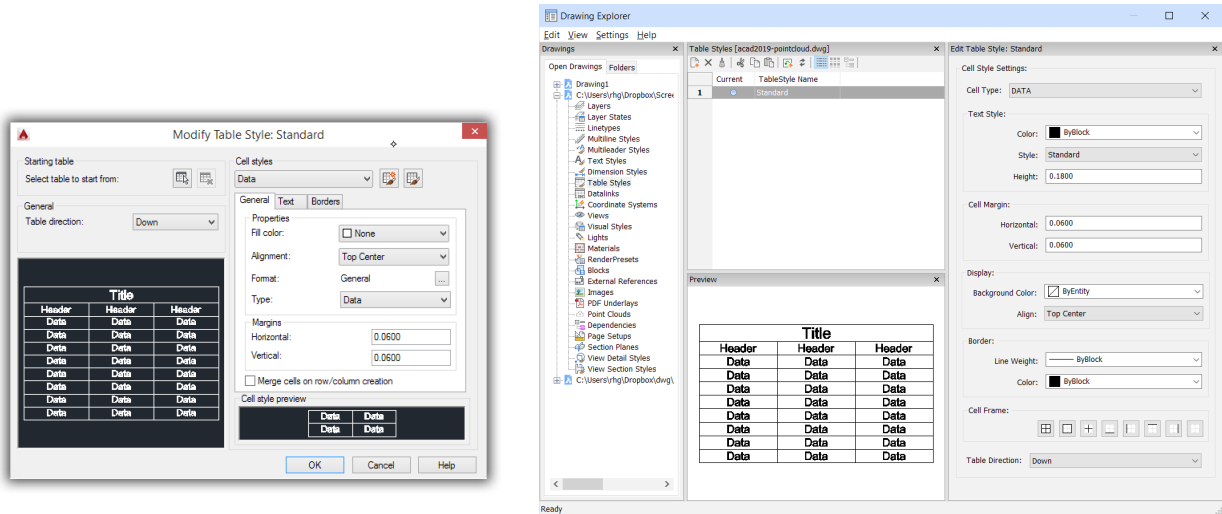

Left: AutoCAD's table properties edited in Modify Table Styles dialog box; right: BricsCAD's table properties edited in the Drawing Explorer

TIP BricsCAD inserts blocks into cells with the **Tinsert** command.

Like AutoCAD, BricsCAD formats cells separately as “titles,” “headers,” and “data.” BricsCAD does not support all of the table properties handled by AutoCAD, as detailed by the table below.

AutoCAD Table Property	Equivalent BricsCAD Table Property
General (Data) properties	
Table Direction	Table Direction
Fill Color	Background Color
Alignment	Align
Text Format	(see Text Properties)
Cell Margins	Cell Margins
Merge Cells	Merge Cells
Text properties	
Style	Style
Height	Height
Color	Color
Angle	...
Borders properties	
Lineweight	Lineweight
Linetype	...
Color	Color
Double Line	...
Double Line Spacing	...
Apply to Borders	Cell Frame

Visual Styles

BricsCAD uses almost the same commands as AutoCAD for named visual styles:

AutoCAD Command	BricsCAD Command
VsCurrent	ShadeMode
VisualStyles	VisualStyles
-VisualStyles	-VisualStyles

BricsCAD includes one more visual style than AutoCAD, specifically the one named “Modeling.”

BricsCAD's VisualStyles command opens Drawing Explorer for creating and editing visual styles:

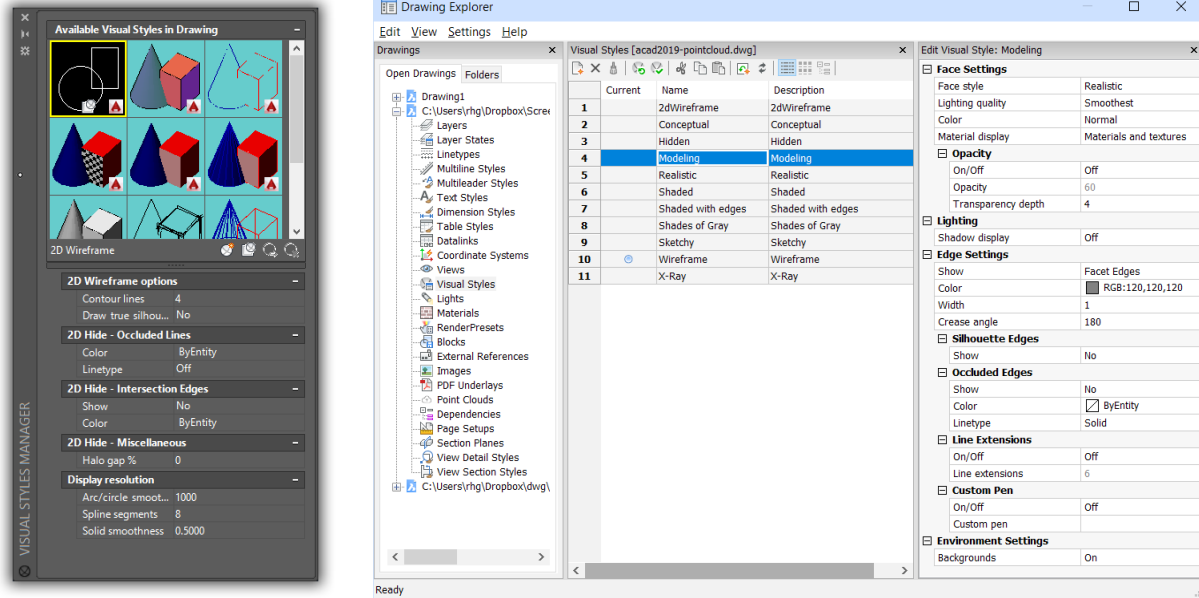

*Left: Visual Styles Manager in AutoCAD.
Right: Drawing Explorer for editing visual styles in BricsCAD.*

BricsCAD supports most of AutoCAD's visual style properties, and has some that are missing from AutoCAD.

AutoCAD Visual Style Property	Equivalent BricsCAD Property
Face Settings properties	
Face Style	Face Style
Lighting Quality	Lighting Quality
Color	Color
Monochrome Color	Monochrome Color
Material Display	Material Display
Opacity properties	
...	On/Off
...	Opacity
...	Transparency Depth
Lighting properties	
Highlight Intensity	...
Shadow Display	Shadow Display
Environmental Settings properties	
Backgrounds	Backgrounds
Edge Settings properties	
Show	Show
Color	Color
...	Width
...	Crease Angle

Occluded Edges properties	
Show	Show
Color	Color
Linetype	Linetype
Silhouette Edges properties	
Show	Show
Width	Width
Intersection Edges properties	
	(not yet implemented)
Show	...
Color	...
Linetype	...
Edge Modifiers properties	
	(not yet implemented)
Extension Lines	...
Jitter	...
Crease Angle	...
Halo Gap%	...

This chapter showed how well BricsCAD reads, creates, and edits nearly the same entities as AutoCAD. Compatibility is important enough for Bricsys to improve the capabilities of BricsCAD with each release.

Customizing and Programming BricsCAD

FOR END USERS WISHING TO CUSTOMIZE BRICSCAD OR AUTOCAD, MOST OF THE ACTIVITY takes place inside a pair dialog boxes that are accessed by these commands:

Program	Settings	Customization
BricsCAD	Settings command (alias: options)	Customize command (alias: cui)
AutoCAD	Options command	Cui command

The **Settings** command in BricsCAD (**Options** in AutoCAD) configures the way the CAD program looks and operates

The **Customize** (**Cui** in AutoCAD) command changes the actions of user interface elements, such as menus, ribbon, and mouse buttons.

Further, you can write add-ons through the use of built-in languages, such as LISP and VBA or through external programming links like BRX (ARx in AutoCAD) and .Net.

This chapter provides you with an overview of customizing and programming BricsCAD. Its emphasis is on the way that BricsCAD does things differently from AutoCAD; there is, after all, no need to learn what's the same! Additional information is available from these sources:

- ▶ For complete details on the topic of customization, refer to the *Customizing BricsCAD* ebook, available for free from https://www.bricsys.com/bricscad/docs/en_INTL/V19/Customizing-BricsCAD-V19.pdf
- ▶ For detailed information on programming BricsCAD, check out the online developer reference available free at https://www.bricsys.com/bricscad/help/en_US/V18/DevRef

CUSTOMIZATION CAPABILITIES

This table illustrates the similarity in customization capabilities between AutoCAD and BricsCAD. Customization methods discussed in this chapter are shown in **boldface**.

Area of Customization	AutoCAD Command	Equivalent Command in BricsCAD
Aliases	... ¹	Customize Aliases
Command bar	Options Display	Settings Command Line
Cursor	Options Display	Settings Display
Double-click actions	Cui Double-click Actions	Customize Mouse
Dynamic input	Options Drafting	Settings Dynamic Input
File paths	Options Files	Settings Files
Fonts	Style	Style
Grips	Options Selection	Settings Grips
Hatch patterns	... ¹	... ¹
Keyboard shortcuts	Cui Keyboard Shortcuts	Customize Keyboard
Linetypes	... ¹	Explorer¹
Menu bar	Cui Menu	Customize Menu
Mouse buttons	Cui Mouse Buttons	Customize Mouse
Plot styles	PlotStyle	PlotStyle
Quad Cursor	... ²	Customize Quad
Quick Access toolbar	Cui Quick Access Toolbars	... ³
Quick Properties palettes	Cui Quick Properties	... ³
Ribbon	Cui Ribbon	Customize Ribbon
Rollover tooltips	Cui Rollover Tooltips	... ³
Scripts	Script ¹ , ActRecord	Script ¹
Selection previews	Options Selection	Settings Selection Preview
Shell commands	... ¹	Customize Shell Commands
Shortcut/Context menus	Cui Shortcut Menus	Customize Menus
Status bar	Right-click, Diesel	Right-click, Diesel
System Variables	SetVar, Options	SetVar, Settings
Tablet	Cui Legacy Tablet	Customize Tablet
Tool palettes	ToolPalettes, Customize	ToolPalettes
Toolbars	Cui Toolbars	Customize Toolbars
UCS icon	USCicon	Settings User Coordinate System
User profiles	Options Profiles	ProfileManager
Workspaces	Cui Workspaces	Customize Workspaces
3D Mouse	Through mouse driver	Through mouse driver

Notes:

¹ File must be edited outside of AutoCAD or BricsCAD with a text editor, such as Notepad

² Not available in AutoCAD

³ Not available in BricsCAD

AutoCAD Options vs. BricsCAD Settings

BricsCAD provides a set of extensive options for controlling your drafting environment, Just like AutoCAD — everything from modifying the look of the user interface to specifying names of project folders. Most settings are stored in system variables that have the same names as in AutoCAD, as well as in data files, many of which are compatible with AutoCAD.

For information and tutorials on moving customization files from AutoCAD to BricsCAD, see chapter 5.

SYSTEM VARIABLES AND PREFERENCES

AutoCAD's primary interface for changing settings is a dialog box displayed by the **Options** command. It provides access to many — but not all — system variables. In BricsCAD, the equivalent dialog box is called up by the **Settings** command. See Chapter 2 for more on how to use this important dialog box.

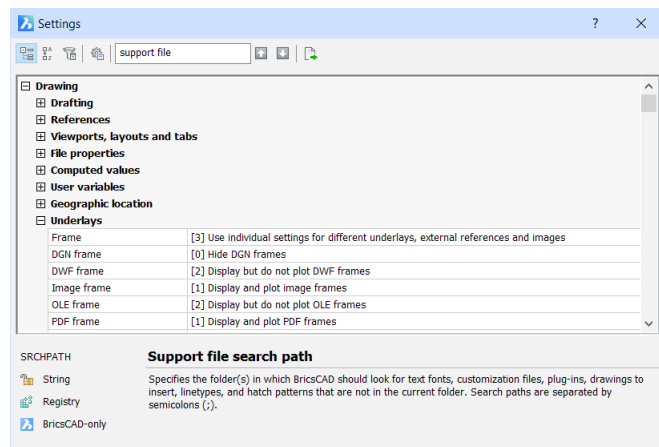
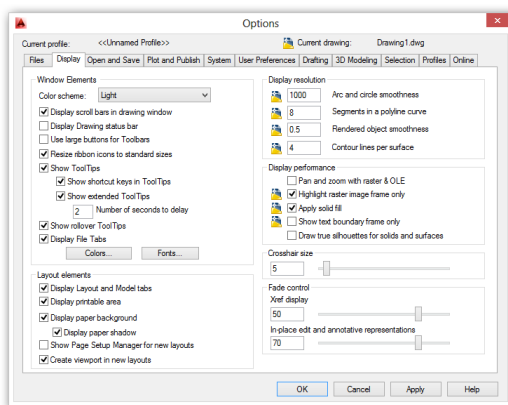

Left: AutoCAD's Display tab in the Options dialog box; right: BricsCAD's Files node in the Settings dialog box

BricsCAD supports most of AutoCAD's system variables; in addition, it has an further set of variables that it calls “preferences.” *Preferences* operate just like system variables. Bricsys gave them the different name to indicate they are unique to BricsCAD. (See Appendix B for the complete list of sysvars and preferences.)

Both CAD programs allow you to enter the names of sysvars and preferences directly at the command prompt. The old **SetVar** command is available also. In addition, BricsCAD exports all the names and settings to a CSV file through an option in the Settings dialog box. (AutoCAD does not do this; instead, use the **Logfileon** command to record the output from the **SetVar** * command.)

FILE PATHS

BricsCAD and AutoCAD drawings use many support files, such as fonts, profiles, and external references. Both CAD programs let you specify alternative paths to these folders, which means that BricsCAD can AutoCAD's support files.

For more information on this capability, see “Common Operations through File Paths” in Chapter 5.

AutoCAD Cui vs BricsCAD Customize

The BricsCAD **Customize** command is equivalent to AutoCAD's **Cui** command. (“Cui” is available as an alias in BricsCAD.) The command displays the Customize dialog box that centralizes customization of many BricsCAD user interface elements.

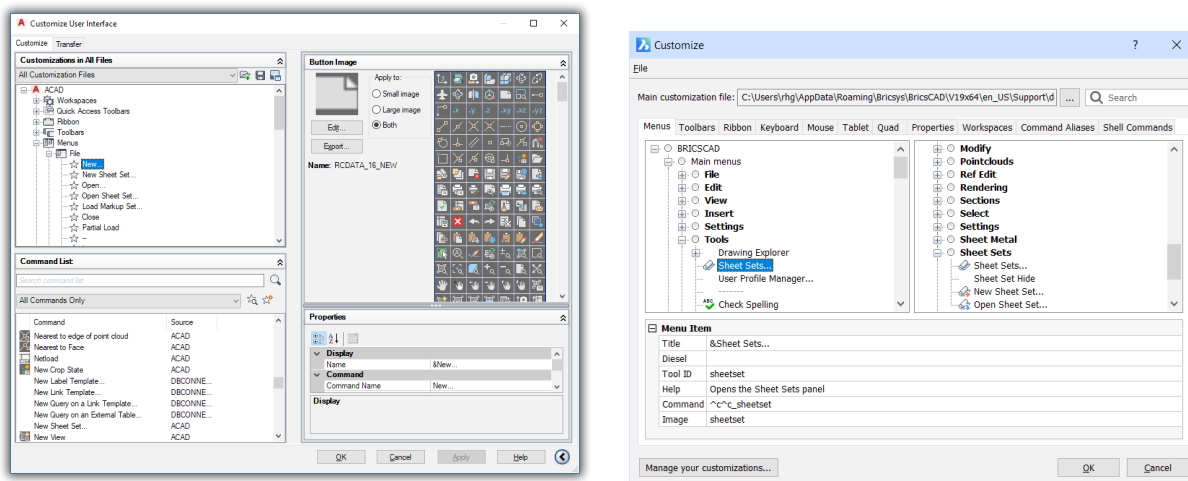

Left: Customize dialog box in AutoCAD; right: ...and for BricsCAD

I find BricsCAD easier to customize than AutoCAD. The tabs in the dialog box perform the following functions:

- ▶ **Menus** tab customizes the menu bar, sub-menus, and context menus (shortcut menus)
- ▶ **Toolbars** tab customizes toolbars and buttons
- ▶ **Ribbon** tab customizes tabs and panels
- ▶ **Keyboard** tab customizes keyboard shortcuts
- ▶ **Mouse** tab customizes mouse buttons and double-click actions
- ▶ **Tablet** tab customizes the tablet overlay menus and stylus buttons
- ▶ **Quad** tab customizes Quad cursor
- ▶ **Properties** tab customizes the Quick Properties displayed by the Quad
- ▶ **Workspaces** tab customizes UI elements shown by workspaces
- ▶ **Aliases** tab customizes command aliases
- ▶ **Shell Commands** tab customizes the shell commands

The process for customizing each element is almost identical in almost all cases. This means that when you learn how to customize one element, such as a menu, then you know how to do any other customization, such as context menus or toolbars.

The way in which BricsCAD approaches customization is, however, different from that of AutoCAD. So in this chapter I show you how, using as my BricsCAD example the customization of a menu.

UNDERSTANDING BRICSCAD'S CUSTOMIZATION TREE

To access the Customize dialog box, use one of the following methods:

- ▶ Enter the **Customize** command
- ▶ Type the **Cui** alias
- ▶ From the **Tools** menu, choose **Customize**
- ▶ Right-click any toolbar or ribbon, and then select **Customize**

When you look at the Customize dialog box, one of the first things that stands out is the ● gray dot that prefixes some menu items. Dots indicate *container* items, which are menu items that contain other items. For example, the File menu contains the following file-related entries:

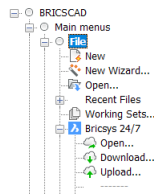

Gray dots indicating container items

The **Main Menu** node defines the structure of the currently-loaded menu. Names like File, Edit, and View match the names on BricsCAD's menu bar. Some editions of BricsCAD may have names that are different from what is shown here.

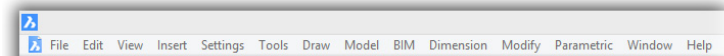





Names on the menu bar matching the list in the Customize dialog box, one for one

Here are examples of containers:

- **BRICSCAD** container holds the names of all *menu groups*. These groups are things like “Main Menu” (the menu items seen on the menu bar) and “Context Menus,” which are the shortcut menus that appear when you right-click entities.
 - **Main Menu** container holds items that appear on the menu bar, such as “File” and “Edit.”
 - **File** container is for the first menu appearing on the menu bar and holds items like “New” and “Open.”
 - **Edit** container is for the second menu on the menu bar.

The row of five dashes “-----” indicates the position of a *separator bar* — the gray lines that you can use to separate groups of menu items.

When you see the  and  buttons (*nodes*), these hold other containers or even submenus. Click a  node to expand sections; click the  node to close them.

How BricsCAD Customizes Menus

The menu bar and its menus are customized in BricsCAD through the Customize dialog box's **Menu** tab. This is where you add, edit, and remove items to and from menus.

Most of your actions will be performed through shortcut menus, like the one shown below. To do so, move the cursor into the Customize dialog box, right-click an existing menu item, and then choose an option from the shortcut menu that appears.

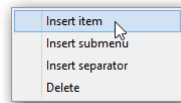

Right-clicking is how things get done in the Customize dialog box

Tutorial: How to Add a Command to a Menu



In this tutorial, you add the **CloseAll** command to the File menu. (The CloseAll command closes all open drawings.) It is to be located after the Close item.

To add the command to the File menu, follow these steps:

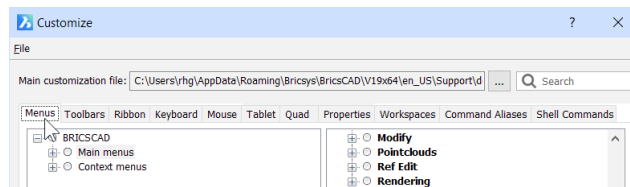
1. Open the Customize dialog box: enter the **Customize** command.
2. When the dialog box appears, click the **Menus** tab.



Accessing the Menu tab in the Customize dialog box

3. To open a container, click a  button. For this tutorial, click the  next to the **File** container.

This reveals the items in the File dropdown menu, as illustrated at left below; the equivalent menu is shown on the right.

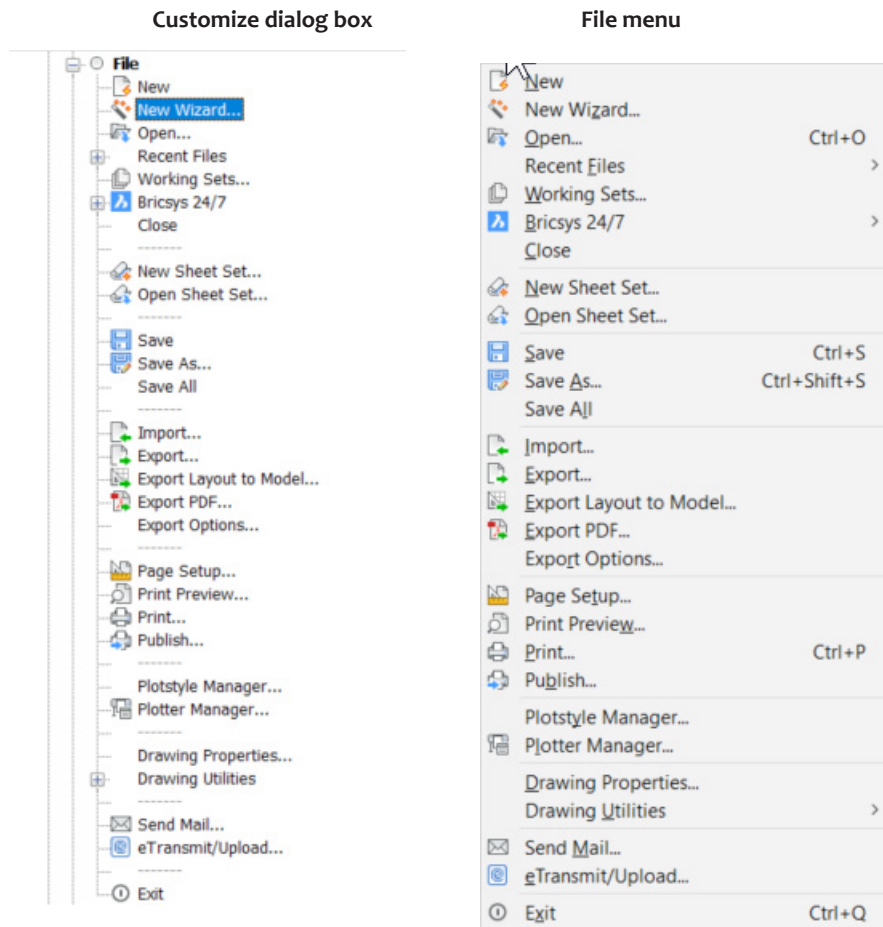

Left: File menu container displayed by Customize dialog box; **right:** Menu items under the File dropdown menu

4. Move the cursor over the ----- (separator) item located below **Close**. You choose this spot, because BricsCAD places new menu items *above* the current one.
5. Right-click (press the right mouse button). Notice the shortcut menu that appears. It holds the commands for adding and removing menu items.

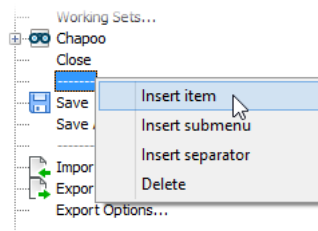

Inserting an item above the selected one

6. From the shortcut menu, choose **Insert Item**. This action adds a new menu item *above* the currently-selected one, the separator line -----.

7. Notice that BricsCAD opens the Add Menu Item dialog box, which lists all commands available in BricsCAD. From this list, you can select existing commands with **Select Available Tool** — or create macros with **Create New Tool**.
- a. Choose the **Select Available Tool** option to access all of BricsCAD’s built-in commands. (The other option, **Create New Tool**, is for creating macros — two or more commands strung together.)

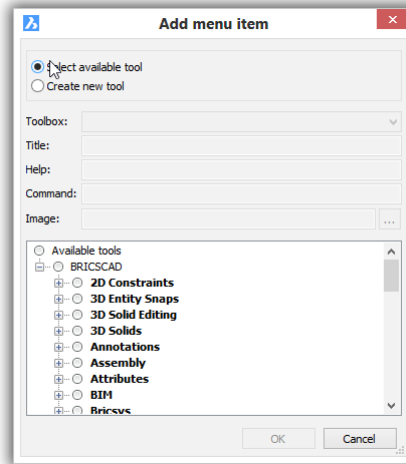

Dialog box for creating new menu items

- b. Under **Available Tools**, scroll down to the **File** item. The fast way to get there is to click any item in the list (such as “2D Constraints”), and then tap the **F** key on the keyboard.

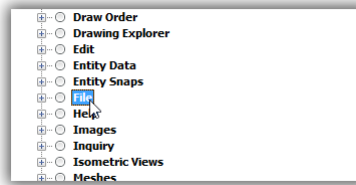

*Getting to the **File** item*

- c. Open the **File** node. Choose **Close All**.

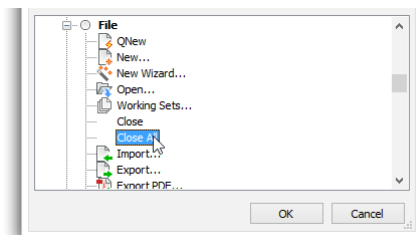

*Choosing **Close All** in the File node*

Notice that in the upper half of the dialog box BricsCAD fills in most of the parameters, such as Title, Help, and so on.

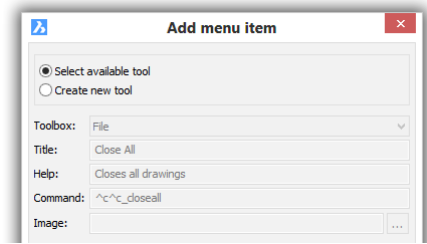

Choosing “Close All” from the list of a available commands

- d. Click **OK**. Notice that the “Close All” command is added to the list of menu items under Close.

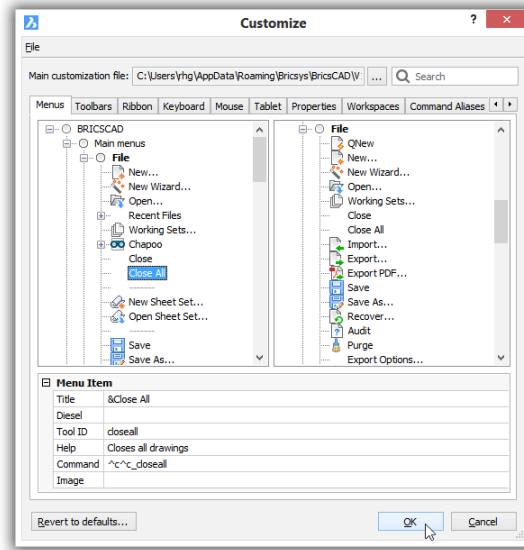

Close All command added to File menu

8. To ensure the new command actually works, test your work always, like this:
 - a. Close the Customize dialog box by clicking **OK**.
 - b. Choose the **File** menu. Notice that the “Close All” item has been added.

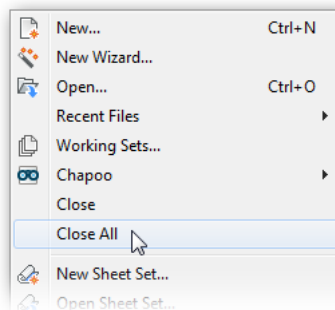

Testing the Close All command

- c. Click **Close All**. Does it work correctly? It should prompt you to save all open drawings that have changed since being loaded.

TIPS FOR WORKING WITH BRICSCAD CUSTOMIZATION

From my experience in customizing BricsCAD, here are answers to questions users have.

Q: Which commands can be add to menus, toolbars, and so on?

All commands can be added. To see a list of all the commands in BricsCAD, peruse the list found the Customize dialog box.

To find a specific command, use the **Search** field. Happily, BricsCAD does not make the same error as AutoCAD, which searches only for *menu* names, not *command* names; you have to know that before you can search. For example, if you search AutoCAD's CUI for the "ObjectScale" command name, you won't find it; you have to search for "Add Object Scale," because that is the command's menu name.

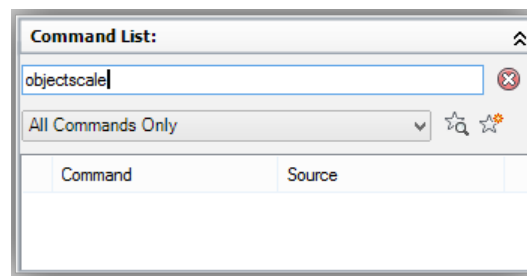

AutoCAD unable to find commands by name in CUI

The good news in BricsCAD is that your search for the ObjectScale command name is fruitful, for BricsCAD finds it.

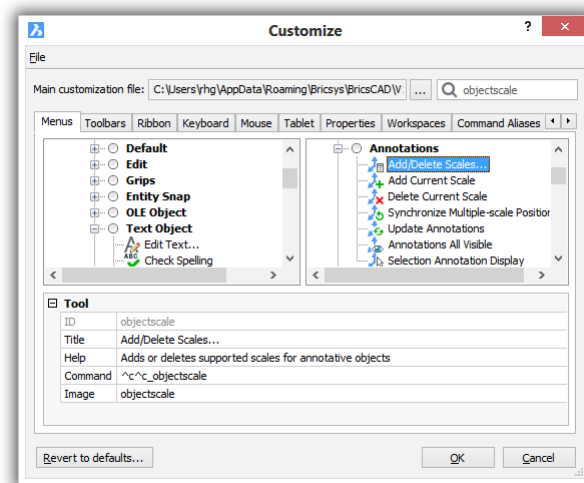

BricsCAD finding commands by name

Q: What's the difference between "Insert" and "Append"?

Sometimes a shortcut menu shows the verb **Append**, other times it shows **Insert** instead. The words seem similar, but have different actions; here's how:

- ▶ **Append Item** adds the new item at the end of the menu container
- ▶ **Insert Item** adds the new item *before* the currently-selected item

The difference does not matter much, because if an item ends up in the "wrong" location, you can just drag it to the correct position.

Q: What do I do when I mangle a customization?

At the bottom of the Customize dialog box in BricsCAD, click the **Manage Your Customizations** button.

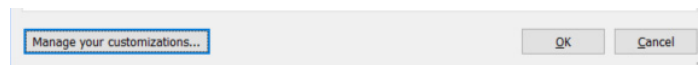

The Manage Customizations dialog box provides an overview of the changes made to the user interface through the Customize command. (AutoCAD lacks this facility.) It shows the changes you made, not all elements of BricsCAD UI.

On the left is the list of user interface elements segregated by workspace name. In this case, many panels were changed.

On the right is information about the UI element you selected, such as for the Drafting workspace. The properties are not editable by you.

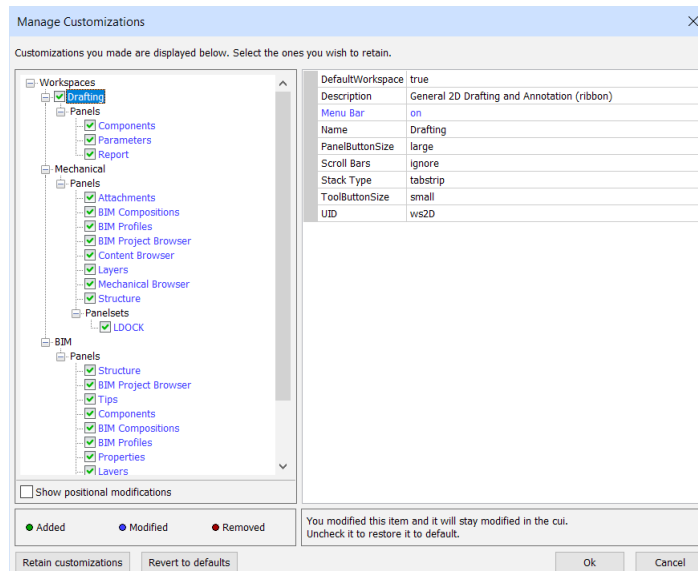

Managing customizations in BricsCAD

The dialog box uses color to identify changes in both panels:

Green — UI elements that were added

Blue — UI elements that were changed

Red — UI elements that were removed

(UI elements that experienced no changes are not listed.)

In the screen grab below, workspace **Drafting** is blue, indicating it was changed. To see what the change was, select it and then look in the right-hand panel: notice that **Menu Bar** is blue, and that its value is on. This means that I changed the Drafting workspace by turning on the menu bar.

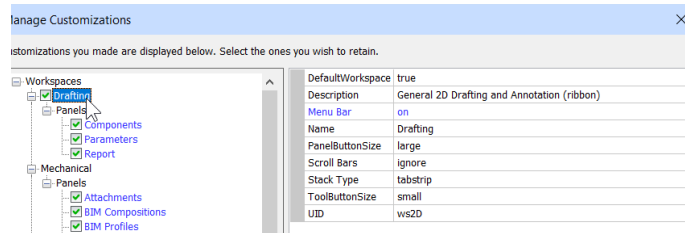

Identifying changes made to UI elements

Similarly, when we select the **Components** panel, we see on the right-hand side that its **Stack Z Order** was changed to 1.

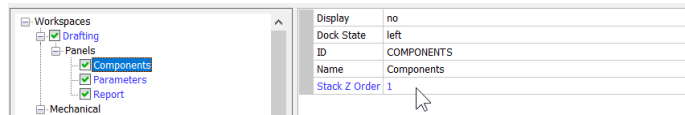

Change made to properties of Component panel

To see the original value of a changed property, click the green check mark, in this case next to Components. Notice that the value turns gray and changes to “<Missing property>”. This means that the panel previously did not have a Stack Z Order assigned.

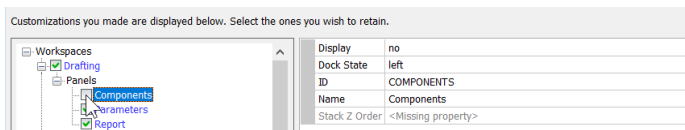

Resetting a changed property

To revert the change, click the box next to Components.

To change everything back to the original, fresh-out-of-the box look, click the **Revert to Defaults** button. Be careful, though, because it removes *all* customizations you made to BricsCAD in this dialog box — except for the ones in the partial CUI files. So, this is why you always should work with partial CUIs!



The nuclear option

CREATING A NEW MENU ITEM IN BRICSCAD

You add new “commands” through *macros*, which BricsCAD calls “tools.” In this tutorial, you learn how to create a tool in BricsCAD. It will consist of two commands: the first command saves the current drawing and then the second one opens the Print dialog box.

I’ve named the macro “Save’n Print,” and it looks like this:

```
^C^C_qsave;_plot
```

Notice that the format of this macro is exactly the same as how it would be written in AutoCAD. *Custom* commands (a.k.a. “macros”) are constructed from other commands, LISP routines, metacharacters, and Diesel instructions — just as in AutoCAD.

You will use BricsCAD’s **Insert Tool** to add this command.

The correct way to add commands is to first create a new partial menu for them. The reason you do this is because of the **Revert to Defaults** button, which you see at the bottom of the Customize dialog box. Should a user (or you, even) click this button, then all customizations are lost! Except, of course, those added to partial menus.

The following tutorial shows you how construct macros for partial menus in BricsCAD.

Step 1: How to Create Partial Menus in BricsCAD

First, create the new partial menu, as follows:

1. In the Customize dialog box, click **File**, and then choose **Create New Partial Cui File**.

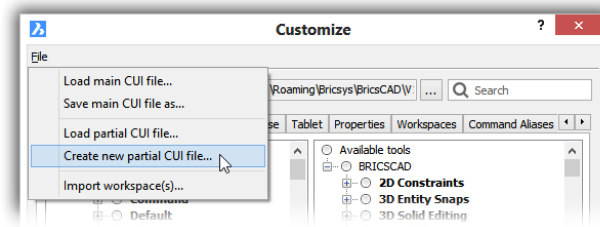

Creating a new partial CUI file

- Notice the Create a Customization File dialog box. In the **File Name** field, enter a name that is brief but descriptive. For this tutorial, enter “my tutorial.”

File Name **my tutorial**

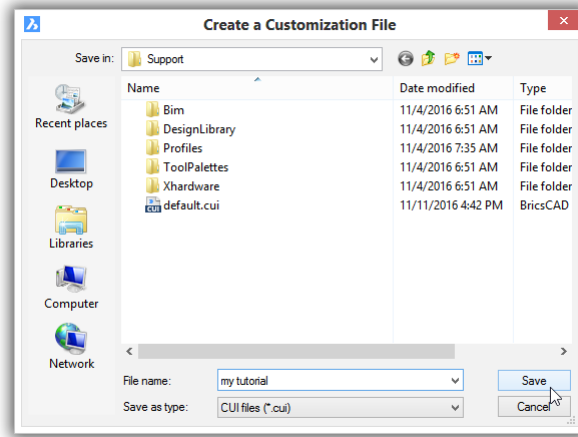

Naming the new partial menu file

- Click **Save**. In the Customize dialog box, notice that “My Tutorial” is added as a node under the Files tab. The “My Tutorial” partial menu is also added to the Toolbar, Ribbon, and other tabs so that it can be used everywhere.

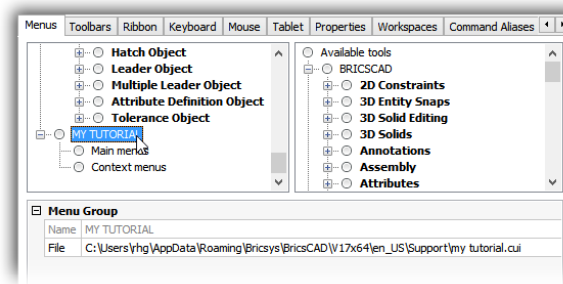

My Tutorial added to menus

- Under My Tutorial, right-click **Main Menus**, and then choose “Append Main Menu.”

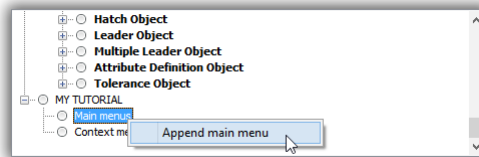

Adding a new main menu item

- The Add Main Menu dialog box opens. Give the new menu its name, like “Tutorial,” and then click **OK**.

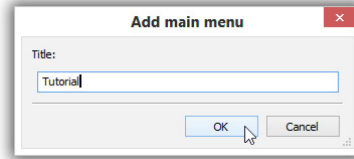

Naming the new menu item

After you click OK to close the dialog box, the new Tutorial menu item appears.

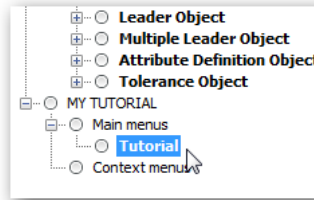

Tutorial menu item added to the tree

- To see this item on the menu bar, close the Customization dialog box by clicking **OK**. Notice that “Tutorial” appears after the Help item and is empty.

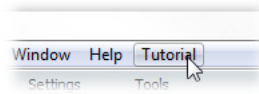

The menu bar showing the new Tutorial item

The partial menu is ready for the next step: adding custom commands.

Step 2: Adding Custom Commands to BricsCAD

To create a new custom command in BricsCAD, follow these steps in the Customize dialog box:

- Look at the right-hand side of the Customize dialog box. In the **Available Tools** pane, navigate to the “My Tutorial” partial menu.

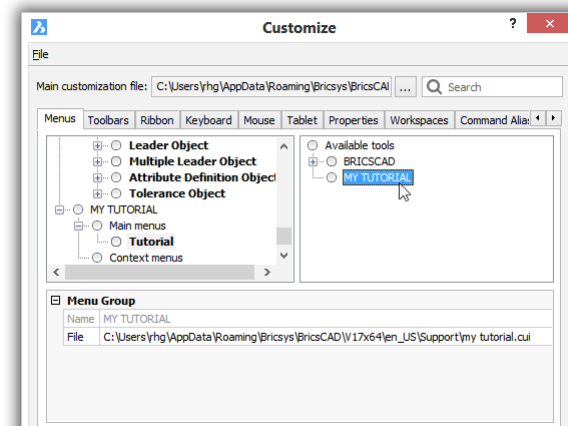

Working in the Available Tools pane

- In partial menus, new commands are collected into “toolboxes.” A *toolbox* is a collection of similar commands, such as ones related to editing or to file management.
To add a toolbox, right-click “My Tutorial,” and then from the shortcut menu, choose **Append Toolbox**.

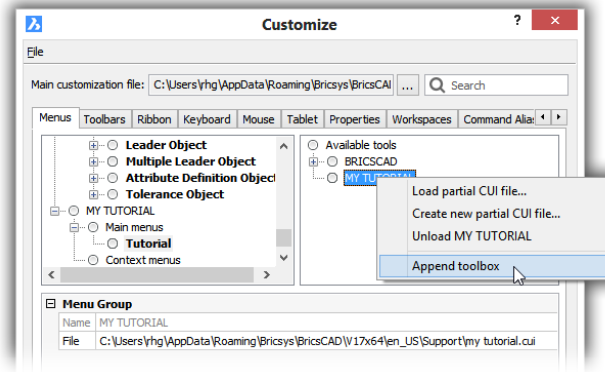

Adding a new toolbox to a new partial menu

- In the Add Toolbox dialog box, enter “Plotting,” and then click **OK**. (A tool is a command.)

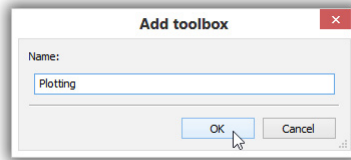

Naming the new toolbox

- The toolbox is created. Go ahead and create the new tool. Right-click and choose **Append Tool**.

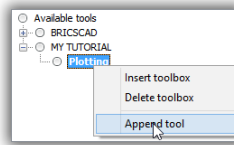

Adding a tool to the toolbox

- The Add Tool dialog box appears. Here you define the new tool. Enter the macro in the **Command** field, as shown below.

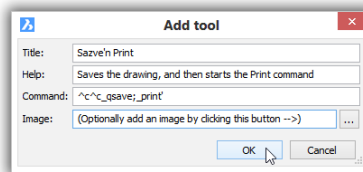

Fields for defining parameters of new tool

You can use the table below as a guide.

Parameter	Text that You Enter	Notes
Toolbox	File	Adds the new command to the File category of available tools
Title	Save'n Print	Specifies the name that appears in the File menu
Help	Saves the drawing, and then starts the Print command.	Specifies the help text that appears on the status bar
Command	^^^C_qsave;_print	Specifies the macro that cancels the current command, saves the drawing, and then starts the Print command
Image	(leave blank)	Specifies the icon, although none is required for menus

- Click **OK** to exit the Add Menu Item dialog box. Notice that the new tool is added to the Tutorial menu (in the left pane of the Customize dialog box), as well as to the list of Available Tools (in the right pane).

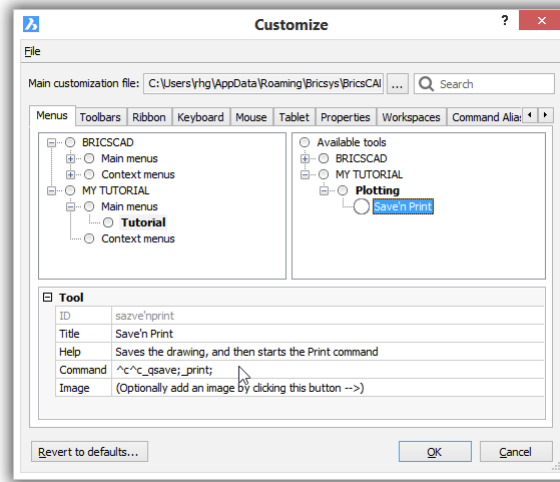

New command appears in both panes

In addition, its parameters are shown in the Menu Item pane at the bottom of the dialog box. Here, you can edit the parameters, just as you can with regular commands.

- Click **OK** to exit the Customize dialog box.
- Test the new item by selecting **Save'n Print** from the **Tutorial** menu.

About BricsCAD's Macro Metacharacters

Menu items execute macros, which can contain *metacharacters*. BricsCAD and AutoCAD use many of the same metacharacters. I've listed some of the most common ones here so that you can see they are indeed identical:

Metacharacter	Meaning
^^C	Cancels the current command.
'	Executes the command transparently.
=	Internationalizes the command.
;	Executes Enter.
\	Pauses the macro.

About BricsCAD's Menu Design Conventions

BricsCAD and AutoCAD use many of the same conventions for designing menus. Two of them are summarized below:

& (*ampersand*) designates shortcut keystrokes for accessing menu items with the **Alt** key

... (*ellipsis*) indicates the menu item will display a dialog box

About Diesel and DCL in BricsCAD

AutoCAD and BricsCAD employ the same Diesel expressions in menu macros and LISP routines, and the same DCL (dialog control language) code for constructing dialog boxes.

CUSTOMIZING CONTEXT MENUS

BricsCAD calls shortcut menus “context menus,” because the menus change their content depending on the context. Context menus are found in the **Menus** tab, below the **Main Menu** section.

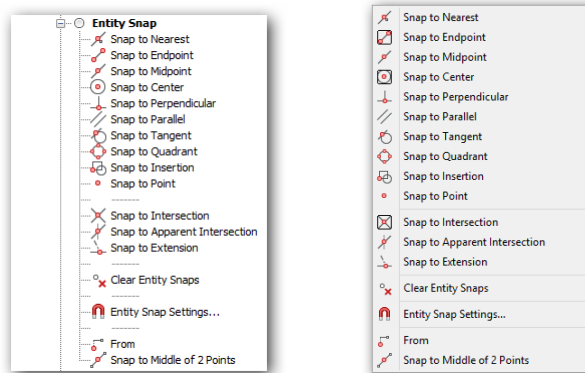

Left: Defining the Entity Snap shortcut menu in the Customize dialog box of BricsCAD; **right:** BricsCAD's Entity Snap context menu.

As with menus, the list of items in each context container matches that of the shortcut menu. For instance, when you right-click, BricsCAD displays the Entity Snap context menu.

To customize a context menu, you have same options as you have with menus:

Menu Item	
Title	&Enter
Diesel	
Tool ID	enter
Help	Completes a command, accepts command values, and cycles grip modes
Command	;
Image	

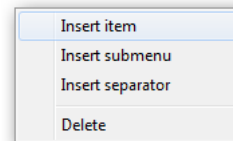

Left: Pane for customizing a context menu item in BricsCAD; **right:** Shortcut menu for adding elements to context menus in BricsCAD.

CUSTOMIZING TOOLBARS

Toolbars are customized in BricsCAD using the **Toolbar** tab of the Customize dialog box.

The process for customizing toolbars is identical to that of customizing menus, with two exceptions:

- ▶ Submenus of toolbars are called “fly outs.”
- ▶ Toolbars can contain “controls,” which menus cannot; control is another name for *droplist*.

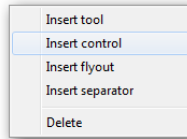

Inserting controls or droplists into a toolbar

You can specify parameters for each toolbar and for each button. As in AutoCAD, BricsCAD can specify the initial location and visibility of toolbars. To do so, (a) select a toolbar name, such as Standard, and then (b) edit the settings in the pane, as shown below:

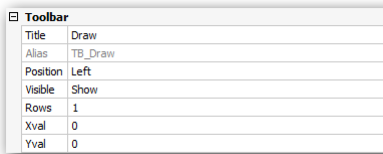

Parameters for positioning toolbars

The parameters for setting the initial position of toolbars are as follows:

Parameter	Options
Position	Floating, Top, Left, Bottom, Right
Visible	Show, Hide

To edit individual buttons, select a name, and then edit the properties:

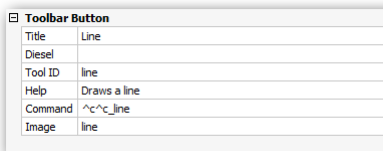

Parameters for toolbar buttons

Similar properties are available for flyouts.

In AutoCAD and BricsCAD, the visibility of toolbars is controlled by the current workspace; all of AutoCAD's toolbars are turned off by default.

CUSTOMIZING RIBBON TABS AND PANELS

The ribbon's tab and panel elements are customized in BricsCAD with the **Ribbon** and Workspace tabs of the Customize dialog box. The design of tabs and panels in BricsCAD is identical to those of Word, AutoCAD, and so on:

- ▶ The ribbon is segregated into one or more “tabs”
- ▶ Tabs contain one or more “panels”
- ▶ Panels contain one or more command elements, such as buttons and droplists

Customizing the ribbon takes place in three areas:

Ribbon. The look of the ribbon is specified by the Workspace tab, where all that happens is the names of tabs to be shown by the named workspace are listed. The figure below shows the names of tabs to be displayed the “2D Drafting” workspace.

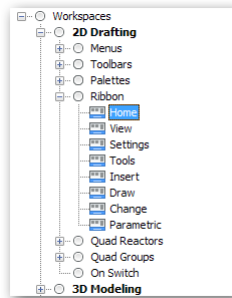

Above: List of tabs to be displayed by the ribbon...

Below: ...and the names of tabs on display in the ribbon

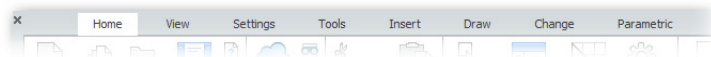

Tabs. Just as a ribbon is just a list of tab names, a tab is just a list of panel names. These are customized by the **Ribbon Tabs** section of the Ribbon tab.

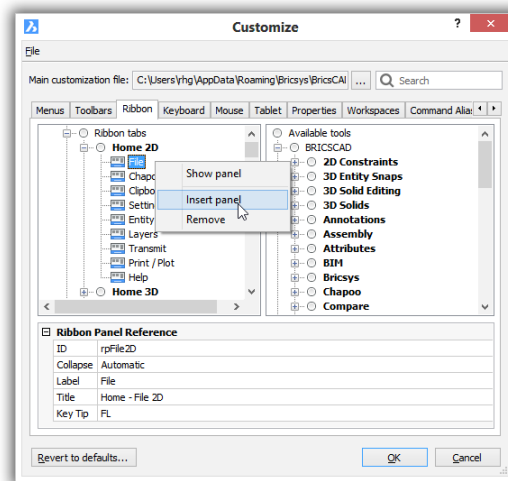

Above: List of panels to be displayed by the Home 2D tab...

Below: ...and the names of panels on display in the tab

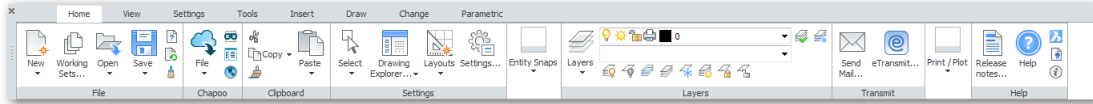

Use the right-click shortcut menu to insert and remove panels. To change the order in which panels appear in the tab, just drag them up and down the list.

Panels. The hard work takes place in designing the panels, as a ribbon can have big and little buttons with and without text labels, buttons strung horizontally or stacked vertically, droplists, and so on. They are customized by the **Ribbon Panels** section of the Ribbon tab:

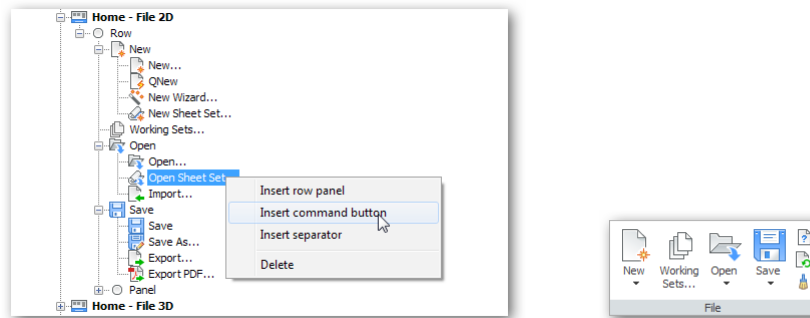

Left: List of commands to be displayed by the File 2D panel... right: ...and the buttons in the panel

I won't go into the details here; they are best left to our *Customizing BricsCAD* book.

CUSTOMIZING KEYBOARD SHORTCUTS

Keyboard shortcuts are customized in BricsCAD by the **Keyboard** tab, as shown in the screen grab below. BricsCAD has many of the same shortcuts as does AutoCAD; see Appendix C for a useful cross-reference of all keystroke shortcuts used by both programs.

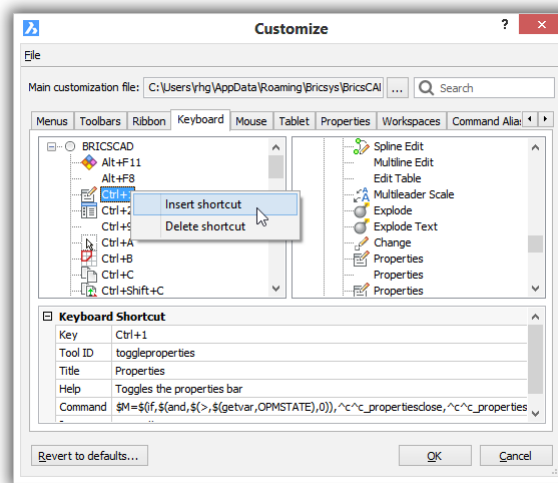

Customizing shortcut keystrokes

To add and remove shortcuts (or edit their assigned actions), right-click an existing one and then choose an option from the context menu:

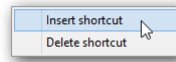

Adding and removing keyboard shortcuts

Adding (inserting) shortcuts follows the same steps as adding menu items. You can enter the following kinds of shortcuts in the **Key** field, highlighted in the figure below:

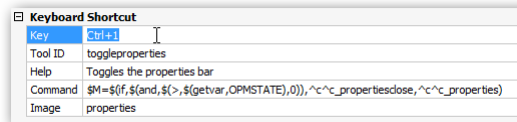

- ▶ **CTRL** keys
- ▶ **SHIFT+CTRL** keys
- ▶ Function keys
- ▶ **SHIFT, CTRL, ALT, CTRL+ALT, SHIFT+ALT, SHIFT+ALT,** and **SHIFT+ALT+CTRL** function keys

BricsCAD does not, unfortunately, warn you if a key combination is already in use.

CUSTOMIZING MOUSE BUTTONS & DOUBLE-CLICKS

The actions of mouse buttons are customized in BricsCAD by the **Mouse** tab, as are double-click actions, as shown by the figure below:

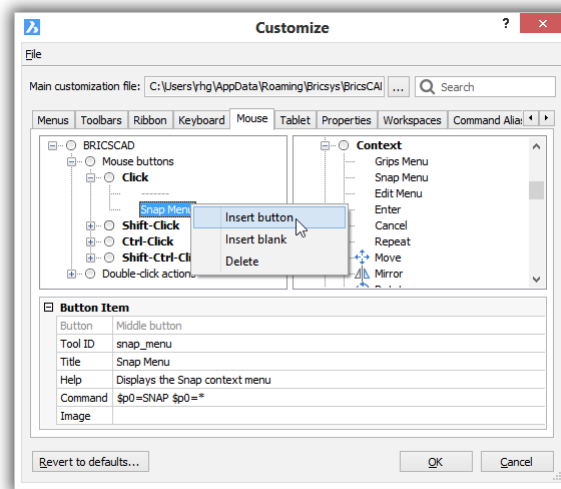

Customizing mouse button actions

To have the click of a mouse button display a menu to the user, you employ the same macro construction as in AutoCAD. See the code highlighted in the figure below:

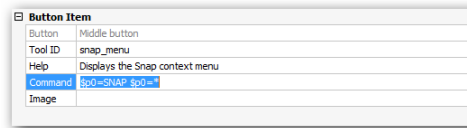

Editing actions for mouse buttons

Double-Click Actions

Double-click actions in BricsCAD are also customized with the **Mouse** tab. Double-click actions are customized in BricsCAD in the Mouse tab of the Customize dialog box. Go down to the **Double-click actions** section, and then edit the **Command** field.

In general, double-clicking an entity causes the Properties pane to appear, but this can be changed; indeed, Bricsys has assigned a number of other commands to the double-clicking of specific entities. Double-clicking a hatch pattern, for example, executes the HatchEdit command.

The lists of double-clickable entities is nearly identical for BricsCAD and AutoCAD. Now, some AutoCAD entities are not native to BricsCAD. As in AutoCAD, you can add and remove double-click actions to and from BricsCAD. To do so, right-click an existing action and then choose an option from the context menu. Inserting a double-click action takes the same steps as adding a menu item; see “Creating a New Menu Item” earlier in this chapter.

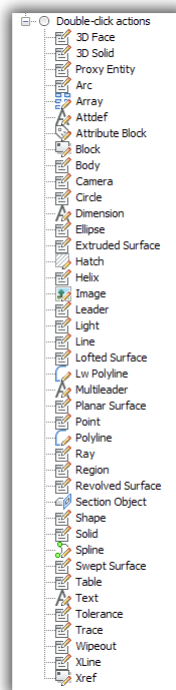

Entities that react to double-click actions

CUSTOMIZING TABLET BUTTONS AND MENUS

Tablet overlay menus and digitizer buttons are customized in BricsCAD through the **Tablet** tab, as illustrated below. Entries under Digitizer Buttons and Tablet Menu initially look empty because no tablet menu is loaded with the Default profile. To add tablet support to BricsCAD, download CUI files and drawings for tablet buttons and overlays from www.bricsys.com/bricscad/tools/Tablet.zip.

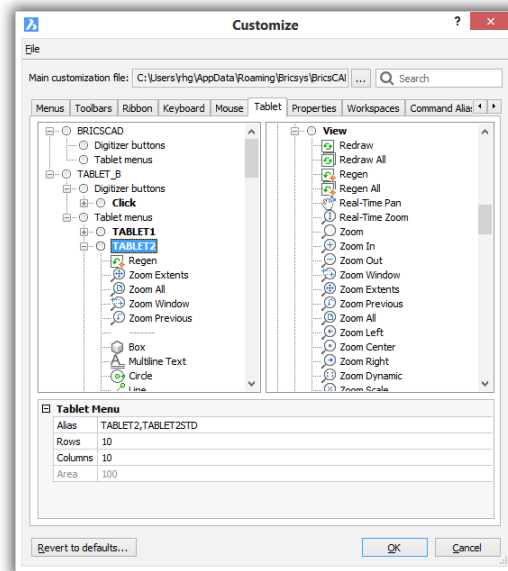

Tablet items appear after the partial CUI file for tablets is loaded in BricsCAD

The tablet overlay drawing provided by Bricsys is illustrated below:

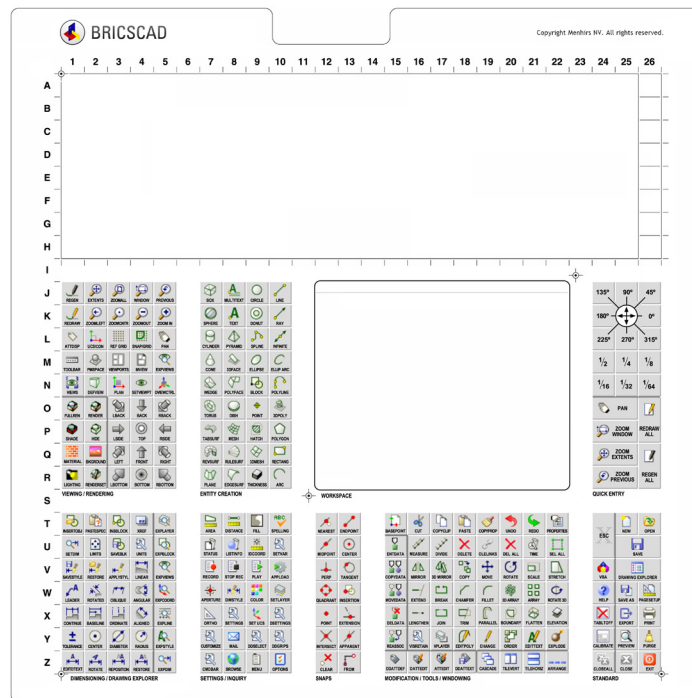

Tablet drawing provided by Bricsys containing the same commands as AutoCAD

After downloading, load the *tablet.cui* or *tablet(acadLike).cui* partial CUI files into BricsCAD with the MenuLoad command (just like you would in AutoCAD). Once one of these partial CUI files are loaded, then two sections in the Customize dialog box are filled with entries for tablet buttons and menus: Digitizer Buttons and Tablet Menus.

CUSTOMIZING QUICK PROPERTIES

Quick Properties in AutoCAD are displayed by a tooltip when the cursor hovers over an entity. In BricsCAD, they are displayed by the Quad.

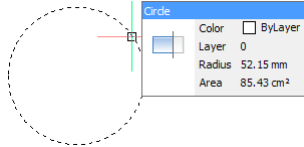

Property information displayed by the Quad in BricsCAD

Just as in AutoCAD, you can specify (customize) the properties displayed for each and every entity type in BricsCAD. This is done through the **Properties** tab of the Customize dialog box.

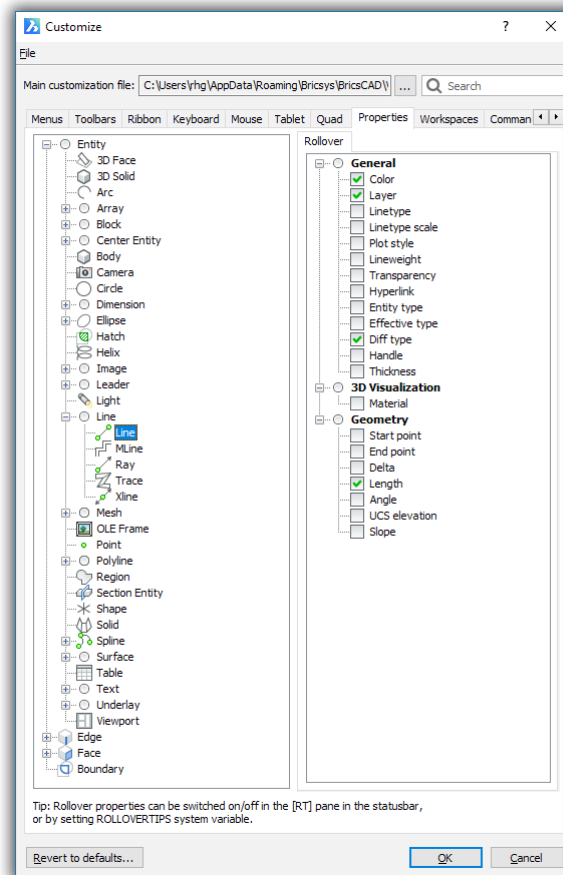

Selecting the properties to display for the 3D Solid entity

Select an entity in the left pane, and then choose which properties you want the Quad to display from the list in the right pane.

If quick properties do not display in the Quad, click the **RT** button on the BricsCAD status bar.

CUSTOMIZING THE QUAD

BricsCAD uses the **Quad** tab to determine the look and functions of its unique Quad cursor.

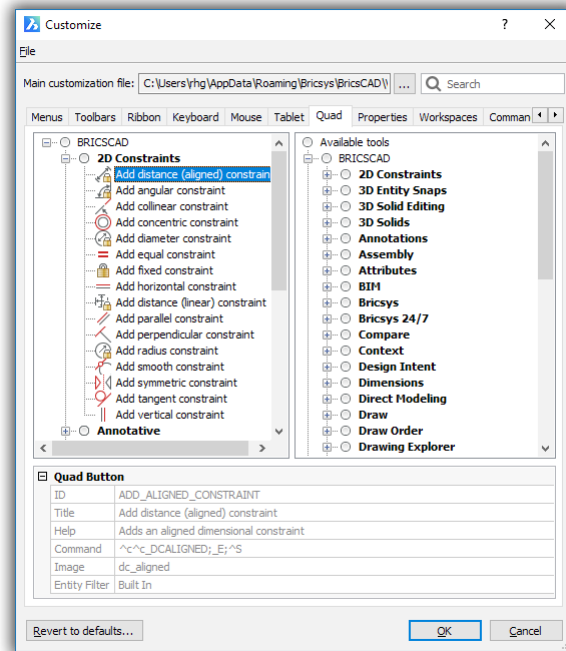

Customizing the Quad

BricsCAD has a unique metacharacter not found in AutoCAD. **^S** selects the entity under the cursor for processing by the Quad. This is a powerful reactor, useful for tasks like one-click dimensioning.

CUSTOMIZING WORKSPACES

Workspaces in AutoCAD and BricsCAD have the same effect on the user interface: they decide which toolbars, palettes, menu items, and ribbon tabs appear when users switch to a different workspace.

Workspaces are customized in the **Workspace** tab of the Customize dialog box.

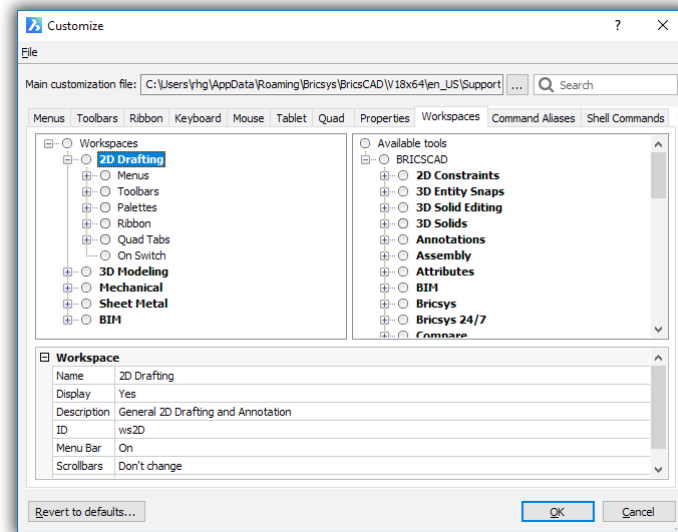

Customizing workspaces in BricsCAD

For instance, to decide which palettes (panels) should be displayed in the “2D Drafting” workspace, open the **Palettes** node, and then turn panels names on or off. It’s that simple

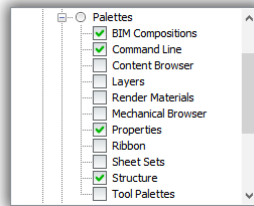

Deciding which panels (palettes) to display

CUSTOMIZING ALIASES AND SHELL COMMANDS

Command aliases are customized in BricsCAD with the **Aliases** tab. BricsCAD has many of the same aliases as does AutoCAD.

In BricsCAD, you create and edit aliases inside the Customize dialog box. To do so, click the **Add** or **Edit** button to see the Edit Alias dialog box, illustrated above. For defining aliases and shell commands, BricsCAD uses the same format for aliases as does AutoCAD.

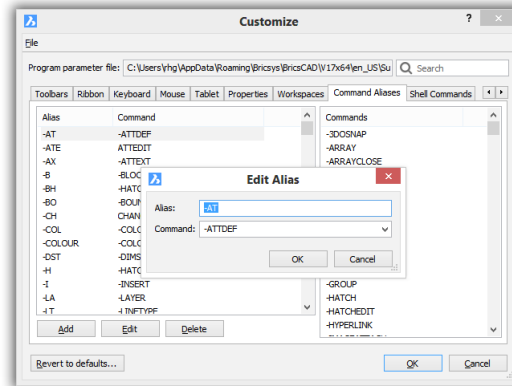

Editing an alias

Both CAD packages store the definition in a *.pgp* file but with different filenames:

BricsCAD aliases are stored in the *default.pgp* file.

AutoCAD aliases are in the *acad.pgp* file

When you copy an *acad.pgp* to a BricsCAD installation, rename the incoming file “default.pgp.”

Shell Commands

BricsCAD users the same format for shell commands as AutoCAD. They are customized in the **Shell Commands** tab, as illustrated below:

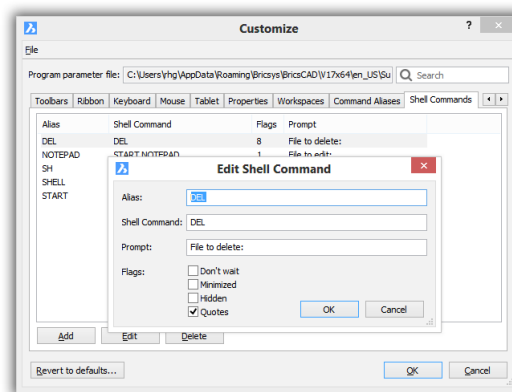

Editing a shell command

CUSTOMIZING TOOLS PALETTES

Tool palettes can be customized, but the process in BricsCAD is different than in AutoCAD. Here is the difference between the two CAD systems in how items are added to palettes:

- BricsCAD** — you drag *commands* from the Customize dialog box to the Tools palette, as described below
- AutoCAD** — you drag *entities* from the drawing into the Tools palette

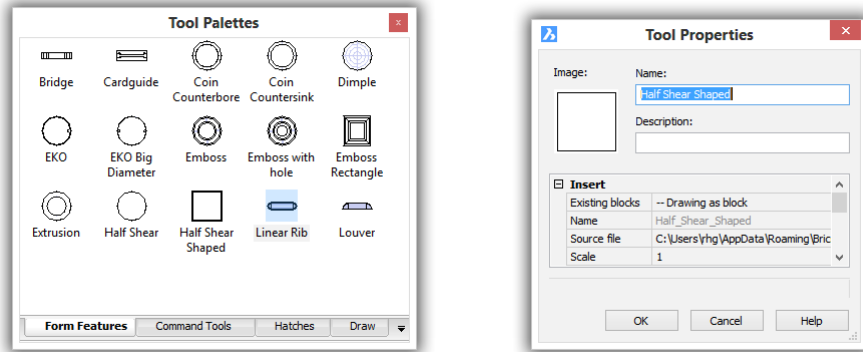

Left: Palette from BricsCAD; right: customizing the actions of an icon

When it comes to palette groups, both CAD programs use a separate dialog box to create and change them, as well as to export and import palette definition files. Despite the presence of the dialog box, BricsCAD cannot, however, create groups, nor does it export palettes.

To access the palette group dialog box:

- BricsCAD** — right-click the Tools palette, and then choose **Customize Palettes**
- AutoCAD** — enter the **Customize** command, which is unrelated to CUI

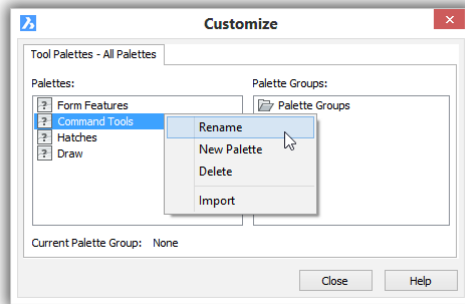

Customizing groups of palettes

(Notice that BricsCAD has *two* dialog boxes named “Customize,” one for customizing the UI and the other for palette groups!) Both programs store Tools palette definitions in external files in XML format:

- ▶ AutoCAD stores palette definitions in ATP files, short for “AutoCAD tool palettes”
- ▶ BricsCAD stores them in BTP files, short for “BricsCAD tool palettes.” Both are XML-format files.

Both CAD systems import palette definitions using XTP files, short for “Xml Tool Palette,” which allows BricsCAD to read palettes from AutoCAD

Other Areas of Customization

Customizing BricsCAD doesn't just occur in the Settings and Customize dialog boxes. Here is a review of additional elements that can be modified, including fonts, linetypes, hatch patterns, and plot styles.

FONTS

AutoCAD and BricsCAD use the same types of font files:

- ▶ TrueType (.tff) fonts
- ▶ Compiled shape (.shx) fonts

This means BricsCAD can use all of the fonts displayed by any AutoCAD drawing.

TrueType Fonts

All TrueType TTF files are stored in a common folder accessed by all programs. AutoCAD and BricsCAD both access the same source, and so there is no need to copy .tff files to some BricsCAD folder.

- ▶ Windows stores TTF fonts in folder `/windows/fonts`
- ▶ Linux stores TTF fonts in folder `/usr/share/fonts/truetype`
- ▶ Mac stores TTF fonts in folder `/System/Library/Fonts`

LEGALITIES: ABOUT COPYING FILES

Autodesk permits the copying of support files, since the corporation understands that drawings are effectively disabled when DWG files are sent to clients without these crucial files. Support files that are coded in ASCII contain the following notice from Autodesk:

Permission to use, copy, modify, and distribute this software for any purpose and without fee is hereby granted, provided that the above copyright notice appears in all copies and that both that copyright notice and the limited warranty and restricted rights notice below appear in all supporting documentation.

When copying files, do so in whole so that you include the notices that Autodesk asks you to preserve.

TRUETYPE FONTS

There is one exception. Some TrueType fonts (.tff files) are commercial products, and cannot be copied without payment to the copyright holder. The good news, however, is that all TrueType fonts provided with Windows and AutoCAD may be copied freely. If a drawing contains copyrighted TrueType fonts, you can often find ones that look similar but cost nothing.

SHX Fonts

AutoCAD keeps SHX fonts in the `C:\program files\autodesk\autocad\fonts` folder. To use them with BricsCAD, you can copy the SHX files to the equivalent folder in Bricsys:

- ▶ Windows stores SHX fonts in folder `C:\Program Files (x86)\Bricsys\BricsCAD V20\Fonts`
- ▶ Linux stores SHX fonts in folder `/opt/bricsys/bricscad/fonts`
- ▶ Mac stores SHX fonts in folder `/Applications/BricsCAD V20.app/Contents/MacOS/Fonts`

AutoCAD also installs TTF versions of its SHX fonts in `\windows\fonts` folder, because TrueType fonts look much smoother and fill better than SHX fonts. If possible, you should use TrueType fonts in your drawings, instead of SHX fonts. While Autodesk continues to provide SHX font files, it only does so to provide compatibility with old drawings.

If necessary, use the `default.fmp` file to map SHX font names to TTF ones. See below.

PFB Fonts

AutoCAD also supports the rarely-used PostScript `.pfb` font format. The support is indirect: you have to use its `Compile` command to convert PostScript fonts into SHX format. BricsCAD does not work with PostScript fonts, but this does not matter as PFB files are actually as SHX fonts in AutoCAD drawing files.

PostScript fonts are the default for Linux, but this does not matter, because neither CAD package uses them directly.

Font Mapping

BricsCAD and AutoCAD support font mapping, something that becomes handy when a font is not displayed in a drawing. This occurs when DWG files are copied from one computer to another, but the second computer doesn't have all of the font files needed by the drawings.

Here are two ways to use font mapping:

- ▶ *Quick'n dirty* method uses the **FontAlt** system variable to specify the name of a single font to use when the correct one(s) cannot be found. Only one font is substituted for all missing fonts. AutoCAD specifies `arial.ttf`, while BricsCAD uses `simplex.shx`.
- ▶ *Comprehensive* method uses the **FontMap** system variable to specify the name of a `.fmp` file, which holds a list of all font names that can be mapped to alternative. Here is where the file is located:

CAD System	FontMap	Default Folder
AutoCAD	<code>acad.fmp</code>	<code>C:\Users\login\AppData\Roaming\Autodesk\AutoCAD\R20.0\enu\Support</code>
BricsCAD Windows	<code>default.fmp</code>	<code>C:\Users\login\AppData\Roaming\Bricsys\BricsCAD\V20\en_US\Support</code>
BricsCAD Mac	<code>default.fmp</code>	<code>Users\login\Library\Preferences\Bricsys\BricsCAD\V20x64\en_US\Support</code>
BricsCAD Linux	<code>default.fmp</code>	<code>home/login/Bricsys/BricsCAD/BricsCAD/V20/en_US/Support</code>

Both CAD systems use the same simple format for FMP files: replacement font names are separated by a semi-colon, one per line. Here are the first few entries of the BricsCAD version of the file:

```
ic-comp;complex.shx
ic-complex;complex.shx
ic-gdt;gdt.shx
ic-ital;italic.shx
ic-italc;italicc.shx
```

Should you need to, copy the *acad.fmp* file from AutoCAD, rename it to *default.fmp*, and then paste it into the folder used by Bricsys.

eTransmit

One way to ensure that Bricsys has all the fonts it needs is to use AutoCAD's **eTransmit** command. This command collects the DWG file, needed support files, all font files, and any attachments, and then places them into a folder or a ZIP file.

There is just one problem: by default, the option to include font files is turned off — for legal reasons. (See the boxed text, “Legalities: About Copying Files.”) To include fonts in AutoCAD, click the **Transmittal Setups** button, choose **Modify**, and then turn on the **Include Fonts** option. See figure below.

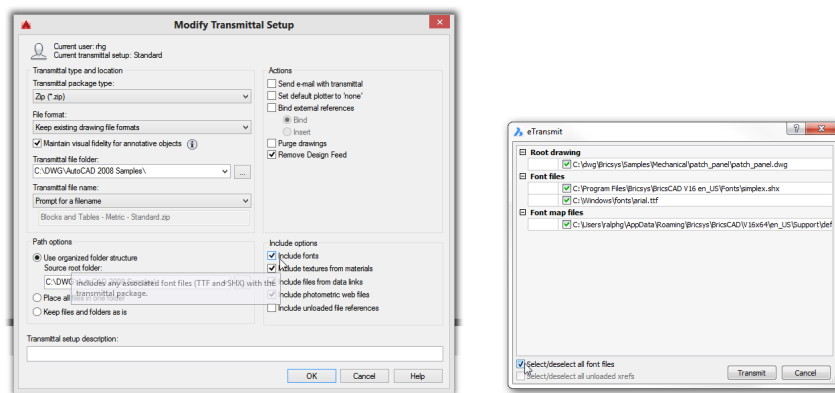

Left: Including all fonts files in AutoCAD; **right:** including the font files in BricsCAD

In BricsCAD, have eTransmit list all font files by turning on the **Select/Deselect All Font Files** option.

If you want just a list of needed fonts and other support files, click AutoCAD's **View Report** button, and you get a list of required and missing files:

```
AutoCAD Drawing Standards File References:
MKMStd.dws
AutoCAD Font Map References:
acad.fmp
AutoCAD Compiled Shape References:
Fonts\txt.shx
Fonts\romand.shx
The following files could not be located:
@Arial Unicode MS.(shx,ttf)
Textures\Mats\
PlotCfgs\Sample Floor Plan_Base.stb
```

LINETYPES AND HATCH PATTERNS

BricsCAD and AutoCAD use the same definitions for linetypes, as well as for hatch patterns:

- ▶ **Simple** linetypes defined by *.lin* files
- ▶ **Complex** linetypes defined by *.lin* and *.shx* files
- ▶ **Hatch patterns** defined by *.pat* files

This means that BricsCAD can use linetypes and hatch patterns that have been customized for AutoCAD. AutoCAD stores LIN and PAT files in folders Windows stores the files in folder *C:\Users\<login>\AppData\Roaming\Autodesk\AutoCAD |R20.0|enu\Support*. BricsCAD stores LIN and PAT files in the following folders:

- ▶ Windows stores the files in folder *C:\Users\<login>\AppData\Roaming\Bricsys\BricsCAD\V20|en_US\Support*
- ▶ Linux stores the files in folder *home/<login>/Bricsys/BricsCAD/BricsCAD/V20/en_US/Support*
- ▶ Mac stores the files in folder */Users/<login>/Library/Preferences/Bricsys/BricsCAD/V20x64/en_US/Support*

Tutorial: How to Copy AutoCAD **.lin** and **.pat** Files to BricsCAD

If you wish to reuse linetypes and hatch patterns from AutoCAD, then follow these steps to copy and rename them:

1. Copy the *.lin*, *.shx*, and *.pat* files from their AutoCAD support folder (see above for its location)...
2. ...to the BricsCAD support folder (see lists above for locations).
3. Once copied, however, you must to rename the files, because BricsCAD uses different file names for default linetype and hatch pattern files. For example, the *acad.lin* linetype file needs to be renamed to *default.lin*. Here is the entire list of file names:

File Type	AutoCAD Default Name	BricsCAD Default Name	Notes
Linetype definitions	<i>acad.lin</i>	<i>default.lin</i>	AutoCAD standard linetypes
	<i>acadiso.lin</i>	<i>iso.lin</i>	ISO-standard linetypes
	<i>ltypeshp.shx</i>	<i>ltypeshp.shx</i>	Shape files for complex linetypes
Hatch pattern definitions	<i>acad.pat</i>	<i>default.pat</i>	AutoCAD standard patterns
	<i>acadiso.pat</i>	<i>iso.pat</i>	ISO-standard hatch patterns

As an alternative to copying and renaming files, you could instead import AutoCAD linetype files into BricsCAD. The drawback is that this method works only on a per-drawing basis, yet could be useful for populating DWT template files. It works like this:

1. In BricsCAD, enter the **Linetype** command to open the Drawing Explorer window at the Linetypes node.
2. Click the  **New** button to display the Load Linetypes dialog box.
3. Click **File** to access other *.lin* files.
4. Use the **Look In** droplist to navigate to AutoCAD's support folder, such as *C:\Users\<login>\AppData\Roaming\Autodesk\AutoCAD |R20.0|enu\Support*. Remember to replace *<login>* with your Windows login name.

5. Choose the *.lin* file you wish to open, and then click **Open**. The linetypes from AutoCAD are added to the current drawing.

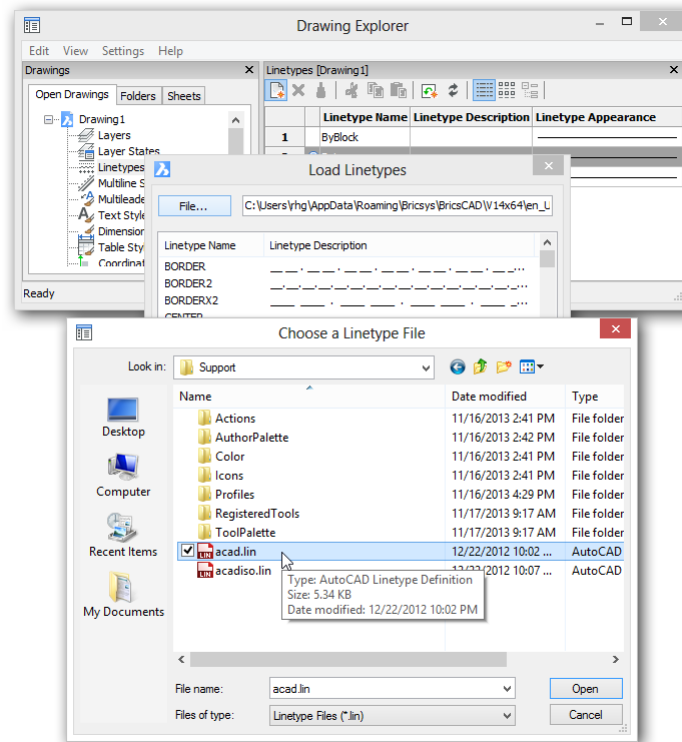

Loading AutoCAD linetype files into the current BricsCAD drawing

Linetypes and hatch patterns are customized by BricsCAD and AutoCAD the same way, editing the related *.lin* and *.pat* files with Notepad or another text editor.

To see custom hatch pattern files in BricsCAD, when their names differ from *default.pat*, set the hatch **Type** to “Custom” in the Hatch Pattern Palette dialog box.

PLOT STYLES

BricsCAD and AutoCAD support both color-based and style-based plot styles that allow entities to look different when plotted. Recall that CTB files are for the older color-based plot style tables, while STB files are for the newer style-based plot style tables. The figures below show that the style-based plot style tables of both CAD programs are identical:

This means BricsCAD can use STB and CTB files created by AutoCAD — after you rename them, because the sole difference is the file name of the default files:

BricsCAD default plot style file is *default.stb*

AutoCAD default plot style name is *acad.stb*

To create or edit plot styles in BricsCAD, use the **PlotStyle** command. Or choose **Plotstyle Manager** from the **File** menu.

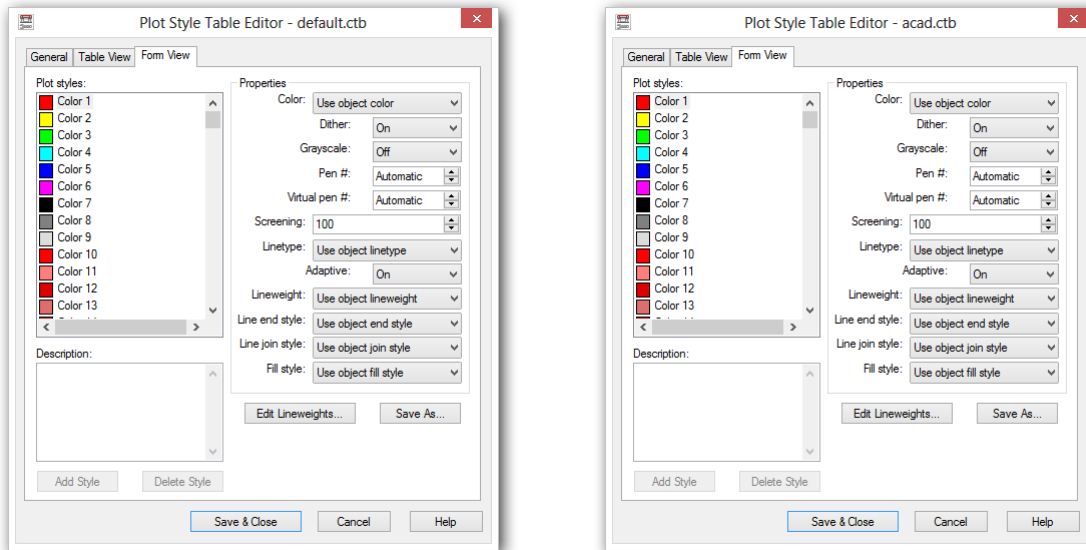

Left: BricsCAD's plot style table; right: AutoCAD's plot style table

Plotter Manager

BricsCAD and AutoCAD both support PC3 plotter manager files, which allow us to customize plotter options. This means that BricsCAD can use PC3 files created in AutoCAD.

The plotter configuration editors of both CAD programs are similar. To create and edit plotters in BricsCAD, choose **Plotter Manager** from the **File** menu, or enter the **PlotterManager** command.

Supported Files

In addition to DWG drawing files, BricsCAD and AutoCAD employ many additional files. The following tables cross-reference by extension supported files between the two CAD packages.

Drawing Files

.adt	.adt	Audit log files
.bak	.bak	Backup drawing files
.dwf	.dwf	Design Web format files
.dwfx	...	XPS compatible version of DWF files
.dwg	.dwg	Drawing files
.dws	...	CAD standards files
.dwt	.dwt	Drawing template files
.dxb	...	Binary drawing interchange files for CAD/camera
.dxf	.dxf	Drawing interchange files, ASCII and binary
.sv\$.sv\$	Autosaved drawing files
.xlg	.xlg	Xref log files
.\$\$\$...	Emergency backup files
.\$ac	...	Temporary files created by AutoCAD
.\$a	...	Temporary files

Support Files

.acb	...	AutoCAD color book files
.acl	...	Autocorrect list files
.arg	.arg	User profile files
.atc	.btc	AutoCAD / BricsCAD tool catalog files
.aws	...	AutoCAD workspace files
.blk	...	Block template files
.cfg	.cfg	Configuration files
.chm	chm	Compiled HTML format help files
.chx	...	Standards check files
.cui	.cui	Customize User Interface files
.cuix	...	Customization container files
.cus	.cus	Custom dictionary files
.dbq	...	Database query files
.dbt	...	Database template files
.dbx	...	Database extension files
.dct	.dic	Dictionary files
.dsd	...	Drawing set description files
.dst	.dst	Sheet set data files
.err	...	Error log files
.fdc	...	Field catalog files
.fmp	.fmp	Font mapping files
.hdi	...	Heidi device interface files
...	.hlp	Windows-format help files
.htm, .html	.htm, .html	Hypertext markup language files

...	.icm	IntelliCAD menu files
.ies	...	Illumination distribution data files
.ini	...	Configuration (initialization) files
.lin	.lin	Linetype definition files
.log	.log	Log files created by the LogFileOn command
...	.lwi	Base material files
.mli	...	Material library files for rendering
.mln	.mln	Multiline style files
.mnc	...	Compiled menu files (deprecated as of AutoCAD 2006)
.mnd	...	Uncompiled menu files containing macros (deprecated)
.mnl	...	AutoLISP routines used by AutoCAD menus (deprecated)
.mnr	...	Menu resource files
.mns	.mns	AutoCAD-generated menu source files (deprecated)
.mnu	.mnu	Menu source files (deprecated as of AutoCAD 2006)
.nfl	...	Filter list files
.pat	.pat	Hatch pattern definition files
.ptw	...	Publish to Web settings files
.pwt	...	Publish to Web template files
.rml	...	Redline markup files (obsolete)
.shp	...	Shape and font definition files
.shx	.shx	Compiled shape and AutoCAD font files
.slg	...	Status log files
.ttf	.ttf	Microsoft font files
.txt	.txt	Text message files
.udl	...	Microsoft data link files
.xml	...	Extended markup language files
.xmx	...	External message files
.xpg	...	XML-format tool palette group files
.xtp	.xtp	Tool palette exchange files

Plotting Support Files

.ctb	.ctb	Color-table based plot parameter files
.pc2	...	Plot configuration parameters files for AutoCAD 2000 (deprecated)
.pc3	.pc3	Plot configuration parameters files since AutoCAD 2000i
.pcp	...	Plot configuration parameters files for AutoCAD R14 (deprecated)
.plt	.plt	Plot files
.pmp	.pmp	Plotter model configuration files
.pss	...	Plot stamp settings files
.stb	.stb	Style-table based plot parameter files

Import-Export Files

.3ds	...	3D Studio files
.bmp	.bmp	Windows raster files (device-independent bitmap)
.cdf	.cdf	Comma delimited files
.dgn	...	MicroStation V8 and V7 design files
.dxe	...	Data extraction files created by DataExtraction command
.dxx	...	DXF files created by AttExt command
...	.ecw	Enhanced Compression Wavelet files

...	.emf	Enhanced meta format files
.eps	...	Encapsulated PostScript files
.fax	...	Fax raster plot files
.fit	...	FIT raster plot files
.gif	.gif	CompuServe image files
.jpg, .jpeg	.jpg, .jpeg	Joint photographic expert group files
...	.jp2	JPEG 2000 files
.kml	...	Google Earth files (keyhole markup language)
.kmx	...	Compressed KML files
.pcx	.pcx	Raster format files
.pdf	.pdf	Portable document format files
.png	.png	Portable Network Graphics raster files
.sat	.sat	ACIS solid object files (short for "Save As Text") files
.sdf	.sdf	Space-delimited files
.slb	.slb	Slide library files
.sld	.sld	Slide files
.stl	...	Solid object stereo-lithography files
...	.svg	Scalable vector graphics
.tga	.tga	Raster format (Targa) files
.tif	.tif	Raster format (Tagged image file format) files
.txt	.txt	Space delimited files
.wmf	.wmf	Windows metaformat files
.xls	...	Excel spreadsheet files
API and Programming Files		
.actm	...	Active macro source code files
.arx	.tx	AutoCAD / Teiga runtime extension files
...	.brx	Bricsys runtime extension files
.cpp	.cpp	ObjectARX source code files
.dce	.dce	Dialog error log files
.dcl	.dcl	Dialog control language descriptions of dialog boxes
...	.drx	Design runtime extension files
.dll	.dll	Dynamic link libraries
.dvb	.dvb	Visual Basic for Applications program files
.fas	...	AutoLISP fast load programs files
.h	.h	ADS/SDS and ARX/BRX/TX function definition files
.lib	.lib	ARX BRX/TX function library files
.lsp	.lsp	AutoLISP/LISP program files
...	.mcr	Macro files
.pgp	.pgp	Program parameters files (external commands and aliases)
.rx	...	Lists of ARX applications that load automatically
.scr	.scr	Script files
.unt	.unt	Unit definition files
...	.vbi	VBA project files prior to BricsCAD V8
.vlx	...	Compiled Visual LISP files

Programming Considerations

By supporting almost the same list of programming languages and APIs as does AutoCAD, Bricsys makes it easy for you to transfer your AutoCAD add-ons to BricsCAD:

AutoCAD API	Equivalent in BricsCAD	Notes
Action Recorder (*)	Scripts, SCR	AutoCAD's Action Recorder scripts cannot be edited; scripts recorded by BricsCAD can be edited.
ActiveX	ActiveX	In-place editing; not available in BricsCAD for Linux or Mac
ADS	SDS	ADS code ported from AutoCAD requires just a recompile using BRX headers; ADS/SDS are deprecated by Autodesk and Bricsys.
ARX	BRX or TX	Ported ARX code requires just a recompile using new BRX headers; when used with TX (ex-DRX), ported ARX code must be rewritten.
AutoLISP	LISP	Ported AutoLISP code runs as-is in BricsCAD; no changes needed, includes support for Vl, Vlr, Vla, and Vlux functions and encryption.
COM	COM	Ported AutoCAD COM code runs as-is in BricsCAD; not available in BricsCAD for Linux or Mac.
CUI	CUI	Ported AutoCAD CUI files made need adjusting for BricsCAD.
Diesel	Diesel	Ported Diesel code runs as-is in BricsCAD; no changes needed.
DCL	DCL	Ported DCL code runs as-is in BricsCAD; no changes needed.
CUI	CUI	Ported AutoCAD menu and toolbar macros work as-in in BricsCAD.
.Net	Teigha.NET	BricsCAD provides Teigha.NET and extra BRX-managed wrappers; not available in BricsCAD for Linux, Mac, or Windows Standard version.
...	TX	Teigha eXtensions (formerly DRX) from Open Design Alliance; not available in AutoCAD.
...	VBA	Current AutoCAD VBA code runs as-is in 32-bit BricsCAD for Windows; not available in BricsCAD Linux, Mac, 64-bit Windows, or Windows Standard
VSTA	...	VSTA is unavailable in BricsCAD.

In general, BricsCAD provides a nearly identical subset of function names. In the case of non-compiled code, such as LISP and DCL, you just drop it into the BricsCAD environment. You recompile compiled code using headers provided by Bricsys. For writing C and C++ applications, BricsCAD offers BRX, which is code-compatible with AutoCAD's ARX. BricsCAD supports SDS, which is compatible with AutoCAD's ADS, although this API is deprecated by Autodesk and Bricsys.

You can reuse *.lsp* AutoLISP routines, and *.dcl* dialog control language files with no modification; in Windows only, *.dvb* projects (VBA macros). Detailed information is freely available from the Bricsys online developer reference at http://www.bricsys.com/bricscad/help/en_US/V18/DevRef.

The screenshot shows the 'Developer Reference Overview' page for BricsCAD V18. It features a table titled 'Availability' that lists various APIs and their support across different operating systems (Windows and Linux) and product editions (Platinum, Pro, Classic).

	WINDOWS			MAC			LINUX		
	Platinum	Pro	Classic	Platinum	Pro	Classic	Platinum	Pro	Classic
LISP	•	•	•	•	•	•	•	•	•
DCL	•	•	•	•	•	•	•	•	•
DIESEL	•	•	•	•	•	•	•	•	•
COM	•	•	•	-	-	-	-	-	-
VBA	•	•	-	-	-	-	-	-	-
BRX	•	•	-	•	•	-	•	•	-
TX	•	•	•	•	•	•	•	•	•
.NET	•	•	-	-	-	-	-	-	-
SDS	•	•	•	•	•	•	•	•	•

ABOUT BRX

BRX is 100% code compatible with ARX, AutoCAD's C++ interface. This means that you need only maintain one set of source code for both CAD platforms. They are not, however, *binary* compatible so modules compiled with ARX cannot be loaded directly into BricsCAD — and visa versa. First, recompile the source code, as follows:

BricsCAD compiles code and link with BRX to run on BricsCAD; The necessary *.h, *.c, and *.tlb files are included in the BRX SDK

AutoCAD compiles code with ARX to run on AutoCAD

The BRX API was developed by Bricsys, and so is available for BricsCAD exclusively. The API is supported on BricsCAD V8 (or higher) Pro and Platinum only, not on BricsCAD Classic or releases prior to V8. The higher the BricsCAD version, the more BRX functions are supported. BRX offers the following functions in common with ARX.

This list is not exhaustive:

- ▶ Common basic functionality, such as AcRx, AcAp, AcCm, AcDb, AcEd, AcGe, AcGi, AcGs, and AcUt
- ▶ Multiple document interface using AcApDocument, AcApDocumentIterator, AcApDocManager, and so on
- ▶ Reactors like AcApDocManagerReactor, AcDbDatabaseReactor, and AcEditorReactor
- ▶ Custom objects derived from AcDbObject, AcDbEntity, and so on
- ▶ Transactions using AcDbTransactionManager, AcTransactionManager, and so on
- ▶ Input point processing with AcEdInputPointManager and AcEdInputPointMonitor
- ▶ MFC-based user interface extensions, such as AcUi and AdUi-based categories
- ▶ COM interfaces callable from C++
- ▶ Undocumented ARX functions, such as acdbSetDbmod, acedPostCommand, acedEvaluateLisp, ads_queueexpr, getCurrentPlotStyleName, and GetListOfPlotStyles
- ▶ Load on demand for commands registered through the AcadAppInfo interface
- ▶ Property palette interface, OPM
- ▶ B-modeler code compatible with A-modeler
- ▶ Hidden Line and Brep APIs
- ▶ Managed wrapper classes for .NET API

ABOUT TX

The TX SDK produces TX modules files with the .tx extension, which are DLLs that are loaded at runtime by BricsCAD. BricsCAD is based on the Teigha libraries from Open Design Alliance, and so TX modules compiled with the TX SDK (Teigha eXtension software development kit) can be loaded to run in BricsCAD.

Prior to V12, the modules were named .dtx. These cannot be loaded into V12 or later; you must recompile the source code using the latest TX SDK. TX classes, methods, and functions seem similar to those in ARX.

There are, however, a number of differences:

- ▶ TX SDK enforces smart pointers in client code.
- ▶ Constructing and destructing objects are different from ARX.
- ▶ Control flow of error handling is different in ARX and TX applications, because error handling is based on exceptions thrown by the Teigha libraries, for the most part, and these need to be caught by the client code.
- ▶ TX SDK contains a subset of ARX, and so functions such as `AcEdJig`, `AcApDocument`, `AcApDocManager`, `AcEdInputPointMonitor`, and `AcUi` are missing.
- ▶ Some basic operations are done differently from ARX, such as retrieving the active database instance or opening entities.
- ▶ There are some minor differences in the class hierarchy of objects.

For more on how to use TX with BricsCAD, refer to the online documentation at http://www.bricsys.com/bricscad/help/en_US/V20/DevRef/source/TX_01.htm.

ABOUT .NET (WINDOWS ONLY)

The BricsCAD .NET API exposes the CAD system's functionality, and allows you to build managed code that runs under the .NET Common Language Runtime CLR. .NET is not available on Linux, Mac, or Classic versions of BricsCAD. With BricsCAD V15, the supported .NET runtime is version 4.0. See <https://www.microsoft.com/net>.

To set up a project with Visual Studio, create a class library using the class library wizard under your preferred .NET language. There are two DLLs that need to be referenced: *BrxMgd.dll* and *TD_Mgd.dll*. The optional *TD_MgdBrp.dll* handles the Brep APIs. These DLLs are located in the BricsCAD installation folder.

When referencing these DLLs, it is important to set the **Copy Local** property to **False**. All other DLLs such as referenced COM DLLs or satellite DLLs, can have their Copy Local property to true, or as needed by your project. Samples projects are found in the `|Bricsys|BricsCAD|API|dotNet` folder.

PORTING AUTOLISP TO LISP

Most AutoLISP routines work directly in BricsCAD. Its LISP engine supports VL and VLA functions, and LISP reactors (except in the Linux and versions), as well as encrypted LISP; it does not support compiling to FAS (compiled LISP) files.

You may experience the following issues:

- ▶ BricsCAD's command line input can vary slightly from AutoCAD's. The solution is to verify the content of all (**command**) functions, or avoid using (**command**) altogether.
- ▶ BricsCAD does not implement a few AutoLISP functions. The solution is to rewrite the code, or to adapt external libraries.

BricsCAD Automation Object Model

See https://bricsys.com/bricscad/help/ro_RO/CurVer/DevRef/source/COM_ComponentObjectModel_Diagram.htm

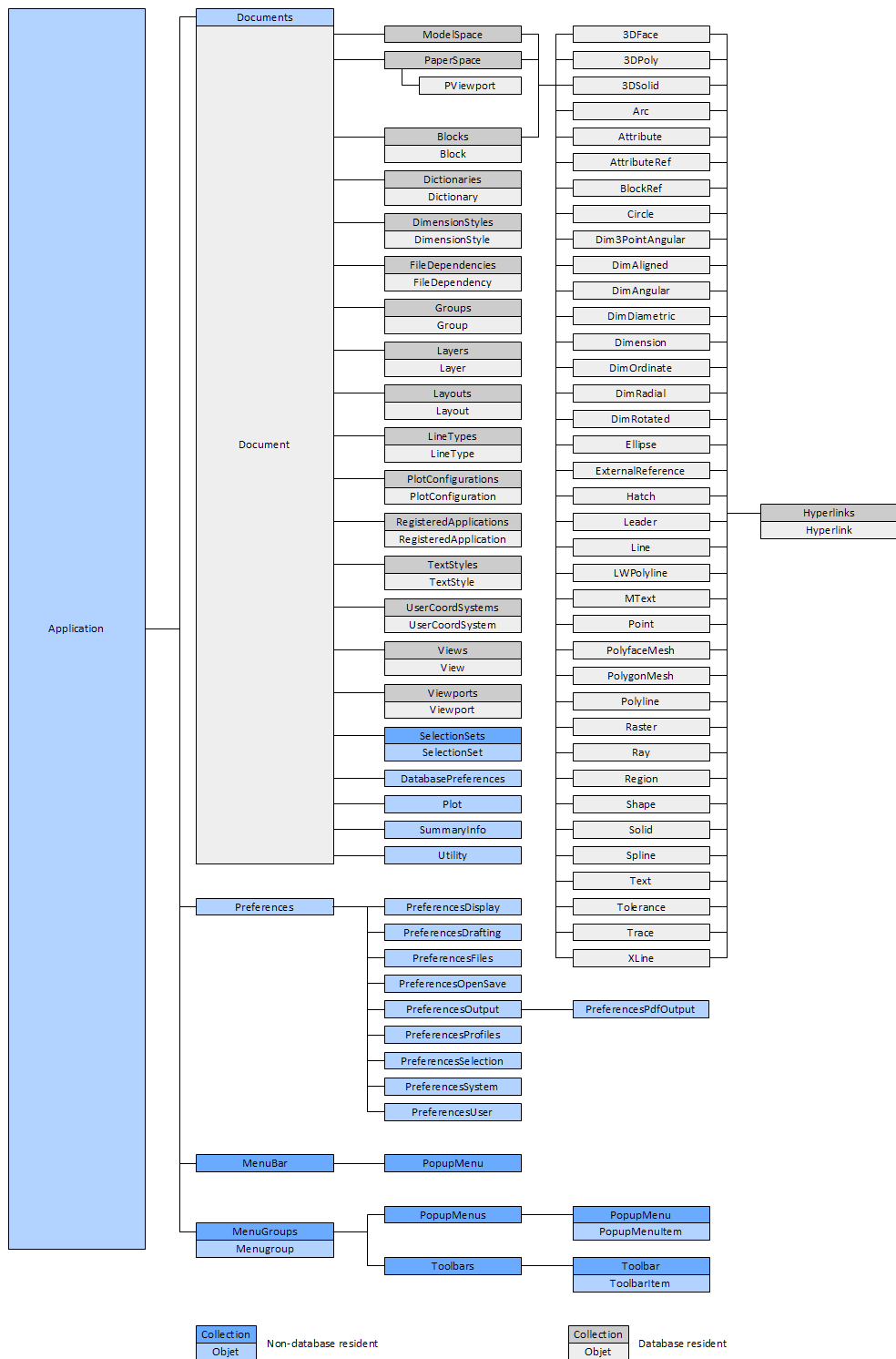

BricsCAD LISP Advanced Development Environment

Bricsys offers BLADE, a more powerful version of Autodesk's VLIDE programming environment for LISP.

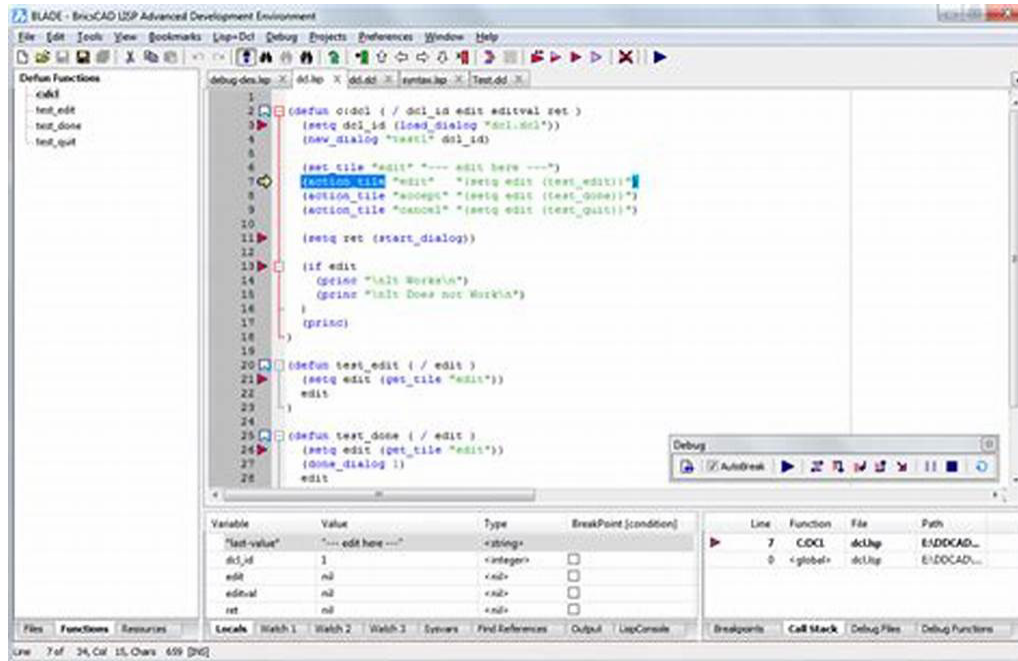

The Blade LISP editing environment

James Maeding provided these tips on using BLADE on the BricsCAD Forum (<https://forum.bricsys.com/discussion/33671/blade-basics>).

- ▶ BLADE lets you check paren closing by double-clicking before or after a paren (“(“ or “)”).
- ▶ “Check text in editor” to see if there are any errors. The report is clickable. The cyan highlighted text takes you to the error area.
- ▶ If you have several files involved in one program, you can set up a *project*, which is a list of the files. Then each project has a little list window.
- ▶ You can double-click on an item in the list to go to or open.
- ▶ You can click a button at the top to “load all lisps in project”
- ▶ You can use Find, and say to look in “all project files”
- ▶ You can compile many lisps to one .vlx, and automatically protect any global vars from other lisps using “separate namespace” (awesome!)
- ▶ You can set a breakpoint with **F9**, then choose **Tools->Load** text in editor. When you run a function, it will stop there and you step through with **F8**, **Shift-F8**, and can also fast forward to other break points with green arrow on debug toolbar.
- ▶ While in debug, you can select a variable, right click, and say “add watch” to see its val.
- ▶ In debug, you can select any var or expression, like (strcat “wow “ “this “ “is great”), and right click “inspect” see the result in a window that stays “pinned” with the val, even after you stop debug.

DOSLib LISP Library

DOSLib is a free library of LISP-callable functions not found in regular LISP. It works with BricsCAD Pro and Platinum. See <https://wiki.mcneel.com/doslib/home>.

PORTING DCL TO BRICSCAD

DCL routines work directly in BricsCAD for designing dialog boxes.

In addition, OpenDCL is fully supported and available for BricsCAD; see <http://opendcl.com/wordpress>.

Porting Diesel to BricsCAD

Diesel routines work directly in BricsCAD for macros and the status bar.

PORTING VBA TO BRICSCAD (WINDOWS ONLY)

AutoCAD and BricsCAD for Windows both use *.dvb* files for VBA projects. BricsCAD Pro and Platinum deliver VBA v7.1., and works both the 32- and 64-bit versions. VBA is not available in BricsCAD for Linux or Mac.

PORTING ADS TO SDS

Since ADS/SDS were developed nearly 20 years ago, Bricsys considers SDS *deprecated*, meaning developers should no longer use it. However, for backwards compatibility, Bricsys supports the old SDS interface.

(ADS is short for AutoCAD Development System, the first API for AutoCAD to use external libraries. SDS is short for SoftDesk Development System, a workalike first developed by SoftDesk for its IntelliCADD project.)

ADS code requires only a recompile using the BRX headers. To run an IntelliCAD-style SDS module on BricsCAD, the code must be adapted as described at http://www.bricsys.com/bricscad/help/en_US/V20/DevRef/source/SDS_01.htm.

PORTING COM TO BRICSCAD (WINDOWS ONLY)

COM (Common Object Model) is available in Pro versions of BricsCAD, and is accessed through programming languages like VB, VBA, VB.NET, C, and C++.

Though BricsCAD's object model is quite similar to AutoCAD's, it is not identical. Nevertheless, most VBx code written for AutoCAD should work directly under BricsCAD. When you find a required element missing from the object model, the BricsCAD developer support team is open to creating the functions you require.

BricsCAD does not support VSTA (Visual Studio Tools for Applications).

LOADING APPLICATIONS INTO BRICSCAD

BricsCAD and AutoCAD use the **AppLoad** command to load applications into each CAD program.

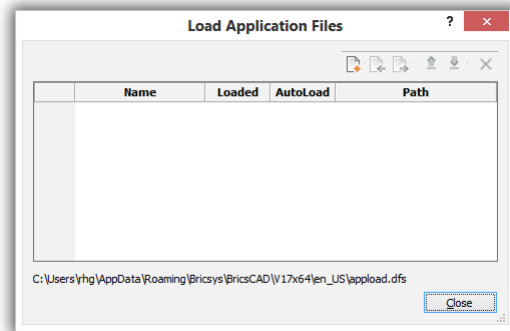
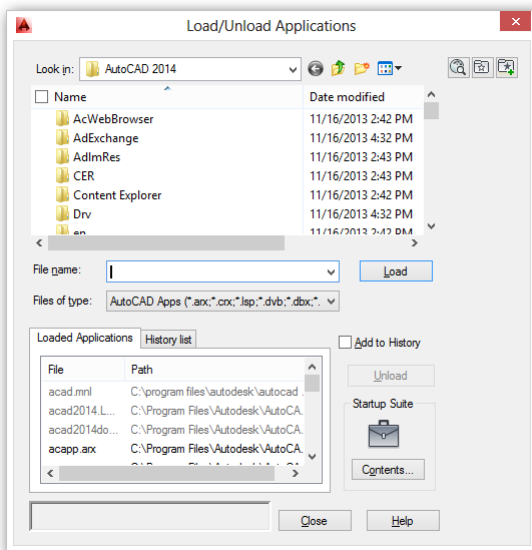

Left: AutoCAD's application loader; **right:** BricsCAD's application loader

Units

BricsCAD and AutoCAD share the same units conversion file, which is used by functions in LISP, SDS, and so on.

BricsCAD calls its file *default.unt*, while AutoCAD's file name is *acad.unt*.

THIRD-PARTY DEVELOPER SUPPORT

Bricsys notes that “There is day to day support for application developers who need assistance porting applications to BricsCAD, or simply require technical information about the porting process and the possibilities. The Bricsys development team has an extended section with dedicated developers for the different development environments (LISP, COM, ADS, ARX, .NET).”

When third-party developers request an addition to the API, it becomes a new feature in BricsCAD that end-users can employ. Bricsys does not charge third-party developers, unlike Autodesk. There is no fee to join, no annual membership, no charge for support, and no royalties on shipping products.

Visit <https://www.bricsys.com/en-intl/applications/developers/> for more information.

Operating Dual-CAD Design Offices

SOME FIRMS OPERATE AUTOCAD OR BRICSCAD EXCLUSIVELY, BUT OTHERS RUN A MIX OF CAD systems. The reality is that it can be done. This chapter explores the realities of running a multi-CAD shop, and explains how to solve issues that may arise.

We also examine the benefits and drawbacks to running the Linux operating system as a cost-saving alternative to Windows and MacOS.

Why Use More Than One CAD System?

It's become common for design firms to license more than one brand of CAD package. Examples include

- ▶ Some seats of AutoCAD, with many seats of AutoCAD LT
- ▶ Some seats of Solidworks, with many seats of DraftSight
- ▶ Some seats of AutoCAD, with many seats of BricsCAD

The CAD manager, however, faces more work when the office runs CAD systems that are different. The differences lie in variations in capability, disparities in licensing policy, varying levels of hardware, and areas of incompatibility.

So why would a design firm cause itself apparently unnecessary grief by taking on these problems? Dual-CAD firms tell me that they adopt a second CAD package for these reasons:

- ▶ **Cost savings** — lower total cost of ownership, as much as \$1 million after nine years
- ▶ **Compatibility** — maximizing compatibility with clients
- ▶ **Capability** — more functionality

If I were a clever motivational speaker, I would call these “The Three Cs to Success.”

LOWER TOTAL COST OF OWNERSHIP

For some firms, it is too expensive to pay \$1,610 every year for every legal installation of AutoCAD. (Prices as stated by the respective CAD vendor Web sites at time of writing.) To save money, they run a majority of their seats on a lower-cost package, such as AutoCAD LT or BricsCAD Pro.

First Year Cost. For instance, a 100-seat design firm might split its workstations 10/90 between AutoCAD and the lower-cost CAD software. The tactic saves the firm over \$40,000 in licensing costs during the first year alone. The table below illustrates the costs of mixing AutoCAD subscription licenses and BricsCAD Pro permanent licenses.

FIRST YEAR COST

Number of Seats	Licensing Cost	Initial Savings
Pure AutoCAD		\$ 0
100 of AutoCAD/year	\$161,000	
Mix of AutoCAD and BricsCAD		\$45,450
10 of AutoCAD/year	\$ 16,100	
90 of BricsCAD Pro ¹	\$ 99,450	
Total Cost	\$ 115,550	
Pure BricsCAD		\$50,500
100 of BricsCAD Pro	\$ 110,500	

¹ Permanent license cost for BricsCAD Pro. I chose Pro rather than Platinum for this cost comparison, because the additional functions provided by Platinum are not found in AutoCAD, such as 3D constraints and assemblies, making it more equivalent.

The actual cost to license one hundred seats is probably lower than that shown by the table, because CAD vendors tend to offer customers better pricing on bulk purchases, although networked versions tend to cost 25% more than standalone licenses.

The prices in the table are accurate as of 22 November, 2018. Note that CAD vendors tend to increase their prices annually.

Upgrade Costs. Following the first year licensing cost, your design firm can choose to spend on additional charges typically associated with software use:

- ▶ Upgrade fees
- ▶ Annual maintenance or support fees, which usually includes upgrades at no added cost

Autodesk as of January 31, 2016 eliminated AutoCAD upgrades and perpetual licenses. In this regard, BricsCAD also has the purchasing advantage over AutoCAD. BricsCAD allows you to upgrade your perpetual license of BricsCAD at any time in the future for a modest fee.

Subscriptions. The third alternative is to purchase all subscriptions instead of some perpetual licences. (Autodesk limits payment to only subscription pricing.) Payments can be made upfront to Autodesk for a month-long use of their CAD software, or else upfront for one year, two years, or three years. This corresponds to being billed monthly, annually, biannually, or triennially. Bricsys offers only annual subscriptions.

The table shows the cost for subscribing to 100 licenses on one-year plans, the only length common to both CAD programs. To be on subscription, Bricsys requires all seats at a single site be on subscription.

TRI-ANNUAL COST

Number of Seats	3-Year Subscription Price ¹	3-Year Cost Savings
Pure AutoCAD		
100 of AutoCAD	\$472,500	\$ 0
Mix of AutoCAD and BricsCAD		
10 of AutoCAD	\$ 47,250	
90 of BricsCAD	\$110,700	\$ 314,500
Pure BricsCAD		
100 of BricsCAD	\$ 123,000	\$ 349,500

¹ Prices in US\$ as reported by each vendor's Web site on 22 November 2018

You can easily set up a spreadsheet to calculate the costs and savings specific to your design firm over any term of years. Note that in the future prices will be higher than this year, but this increase is partially offset by the fact that both firms increase their prices — so the overall savings remain.

Subscription Pros and Cons

The advantages and disadvantages to paying by subscription are as follows:

- ▶ **Pro:** The upfront financial cost is 1/3 less than that of a perpetual license
- ▶ **Con:** A subscription becomes more expensive than a pure perpetual license after three years

- ▶ **Pro:** Being a subscription, the amount is 100% deductible from income taxes (depending on the law in your jurisdiction)
- ▶ **Con:** In some jurisdictions, the full permanent license cost is depreciated 100% after just two years, which is a better tax break

- ▶ **Pro:** Firms can reduce costs by reducing license counts when the work load lessens, such as during recessions, or can rent software monthly when the workload jumps
- ▶ **Con:** CAD vendors may pressure firms to not reduce their license count under the threat of higher fees (this actually occurred during the 2008 recession); subscription-paid software stops working after 15 to 30 days, should the firm be unable to afford the next payment

- ▶ **Pro:** Subscriptions often include additional benefits, such as free upgrades, better support, and extra software at no cost
- ▶ **Con:** Subscription prices increase over time, and benefits fluctuate as CAD vendors alternate between wanting more revenue (raising prices over the long term) and wanting more new customers by putting subscription prices “on sale” or increase benefits

Hardware. I did not include the benefit of using older and slower hardware with BricsCAD, as this cannot be easily quantified financially; there are too many variations in workstation features and pricing. For instance, as I write this section, I bought a refurbished Dell slim-profile workstation for \$150 (excl. monitor): 4GB RAM and 2.8GHz dual-core CPU, the kind that suits BricsCAD just fine. It does not require the more expensive computers and graphics boards that AutoCAD requires to run well.

The advantage goes to BricsCAD, as initial hardware costs are lower and subsequent hardware upgrades are rarer. In the end, a 100-seat site is looking at saving over \$1,000,000 over nine years.

Country-Biased Pricing

Both Autodesk and Bricsys charge different prices for different countries. You can learn the current price schedule for your country by visiting these online shops:

- ▶ Autodesk: <http://www.autodesk.com/store>
- ▶ Bricsys: <https://www.bricsys.com/estore/>

The pricing situation is acute for firms in developing countries, where starting architects make as little as \$300 a month. In my opinion, I find it disturbing when software companies charge more in these high-growth, low-income countries, thereby placing software tools out of reach of potential customers. Ironically, software companies complain about the high rate of piracy in developing countries — they fail to see the connection.

To save customers money in the early design stage, Bricsys provides BricsCAD Shape for free. This is a 3D-only modeler that accepts materials, inserts blocks, and is 100% compatible with BricsCAD. The company sees it as a replacement to SketchUp.

Another way to save money is to run the free Linux operating system on computers, instead of Windows, whose cost is bundled into the price of computers. While MacOS is free, it runs only on Apple-branded computers, which tend to be the most expensive ones. Also, Apple halfheartedly makes hardware for professionals. The catch to offices employing Linux is that the CAD vendor must have a version of the software that runs on Linux. Autodesk does not; Bricsys does.

Linux is doubly cost-effective, because it runs well on older, less powerful computers. Newer releases of Windows typically require new hardware, if only because the updated operating system no longer supports older device drivers or software.

In summary, BricsCAD is triply cost-effective:

- ▶ BricsCAD Platinum is priced 4x less than AutoCAD, and 1.5x less than AutoCAD LT
- ▶ BricsCAD runs on Linux, which is free
- ▶ BricsCAD and Linux have lower hardware demands than AutoCAD and Windows, and so run effectively on older computers

MAXIMIZING COMPATIBILITY WITH CLIENTS

Like all responsible capitalist corporations, design firms look to reduce their expenses, and so prefer the lowest-cost system that produces the highest profits with the fewest expenses — measurable and unmeasurable. Above, I listed some of the measurable expenses above; let's look at the ones that are not measurable.

The #1 unmeasurable expense comes from the **difficulty** in using a software system. In the case of CAD, this can mean difficulty of the user interface, links to external programs, and absolute compatibility with the industry standard, AutoCAD. For this last reason, design shops employ at least a few seats of AutoCAD.

For many years, Autodesk put huge resources into leapfrogging AutoCAD ahead of the competition. As of AutoCAD 2014 onwards, however, Autodesk slowed its pace. The flagship software gains only a few new functions each year. The DWG format remains unchanged for as long as five years at a time.

Nevertheless, most design firms have at least one license of AutoCAD on the chance that drawings from clients might not reproduce correctly in an IntelliCAD or a BricsCAD. This is no different from firms saving money by standardizing on the free Libre Office package, yet maintaining a license of Microsoft's Office to ensure compatibility with files created by the *de facto* standard in office software.

Open Design Alliance. The industry counterweight to Autodesk is the Open Design Alliance. The ODA was established in the late 1990s to document Autodesk's DWG format, which has been kept proprietary. (As a result of the formation of the ODA, Autodesk relented and documented DWG through its own API, RealDWG.)

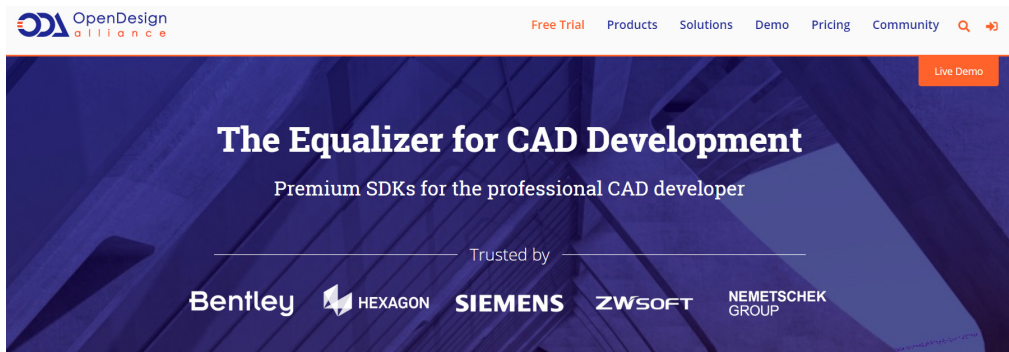

Home page for the Open Design Alliance

Today, the ODA organization has 1,200 members and provides application programming interfaces that allow members' software to read and write AutoCAD DWG, DXF, and other popular file formats, such as MicroStation DGN, Adobe PDF, and Revit RVT. The organization also provides resources such as an equivalent to Autodesk's ARx programming interface, ADT and MDT object enablers, and the licensing of add-on software like ACIS and C3D solid modeling kernels. <http://www.opendesign.com>

ODA and its contract programmers do the hard work by figuring out what's inside DWG. This means that BricsCAD and other firms can concentrate on adding features to their CAD systems. The bad news is that Autodesk has in the past changed the *content* of the DWG files as often as every year to add more capabilities and object types. The good news is that the ODA's programmers usually figure out the new content in under six months, which is why new releases of BricsCAD tend to come out each year in October or November.

CAPABILITY THROUGH MORE FUNCTIONS

For a few years, Autodesk added really big features to AutoCAD, such as 3D subdivision mesh modeling, 3D surfaces, point cloud processing, and dynamic blocks. The bad news is that these huge additions kept workalikes from replicating these complex functions in their entirety. On their own, they don't have the programming resources; banded together under ODA, however, they make progress.

The good news is that the for workalikes often don;t need to replicate AutoCAD completely. It turns out that 3D point clouds and the like are of little interest to heads-down drafters. If a design firm needs the capability, there are many third-party stand-alone products that do as good a job as AutoCAD in this area — or better.

The majority of AutoCAD and BricsCAD users produce 2D drawings. A Solidworks product manager once proclaimed at a users conference that “2D will go on and on, probably for 50 years.” At any user conference, the biggest cheers are reserved for new functions that save time in 2D drafting, like automatic balloon placement. Even in hard-core 3D CAD environments, such as Catia, the numbers indicate that more than 50% of drawings are produced in 2D. (Catia from Dassault Systemes is high-end 3D modeling software used by aircraft and automotive firms, among others.)

Nevertheless, 3D cannot be ignored, and workalikes traditionally have been weak in that area: IntelliCAD and other workalikes have achieved today what AutoCAD did more than a decade ago.

The primary exception is BricsCAD, which is taking big strides in beefing up its 3D offerings.

- ▶ With V11, Bricsys added a higher-priced Platinum Edition that offered 3D history-based parametric modeling, known as X-Solids. It included a parametric parts library, called X-Hardware.
- ▶ With V12, Bricsys added 3D direct modeling and 2D constraints to all editions, with 3D constraints added to the Platinum Edition.
- ▶ With V13, Bricsys added assembly modeling for linking two or more 3D models using constraints, kinematic analysis for checking motion and interference between parts, and bills of materials.
- ▶ With Communicator, Bricsys added import and export for popular MCAD formats such as Solidworks, Inventor, and IGES
- ▶ With V14, Bricsys added sheet metal design and assemblies.
- ▶ With V15, Bricsys greatly expanded sheet metal design, began on BIM (building information modeling for architects), and added a link to CAM.
- ▶ With V16, Bricsys added 3D surfacing, beefed up the capabilities of BIM and generative drafting, added 3D lofting, and began importing MCAD assemblies.
- ▶ With V17, Bricsys added 3D compare of modified 3D models, IFC certification, and real-world material specifications.
- ▶ With V18, Bricsys added more BIM functions, expanded capabilities to sheet metal design, added the Manipulator widget for interactive 3D editing, and introduced the free BricsCAD Shapes software.
- ▶ With V19, Bricsys added automation to applying repeated elements to building models, expanded the sheet metal design capability, added a parametric 3D parts library, and so on.
- ▶ With 20, Bricsys added support for Autodesk ReCAP point cloud format, made Blockify command common to all editions, and recognizes civil engineering data and commands.

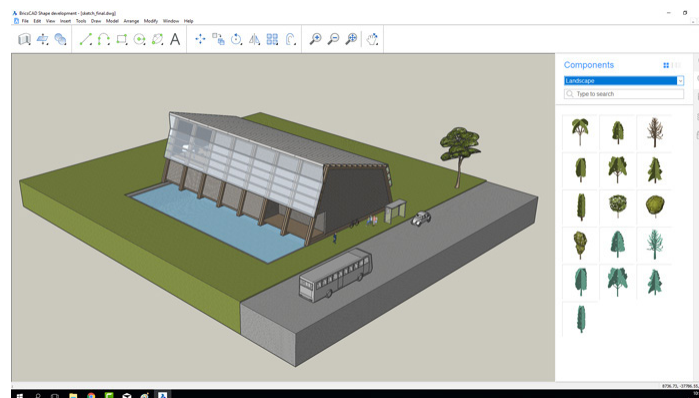

Bricsys Shape for preliminary 3D modeling

Running BricsCAD & AutoCAD in One Office

To run more than one CAD system in your office successfully, it is important to understand the differences between them. Differences exist, because the abilities of AutoCAD and BricsCAD differ.

Read this chapter, then establish an in-house workflow to assign drafting tasks appropriate to each CAD system. I describe this in the following section. The advice we give is based on the experiences at offices that actually implemented BricsCAD and AutoCAD.

The primary roadblock comes when you find a feature missing in a CAD system, then you will need to find a workaround. For instance, should BricsCAD cannot handle certain entities, you can xref drawings from the other CAD system into BricsCAD. BricsCAD can display nearly anything that AutoCAD can draw, but does not create or edit every entity type.

In summary, BricsCAD has the following capabilities *vis a vis* AutoCAD:

Activity	BricsCAD can...
View	...display nearly all AutoCAD entity types, even if it cannot edit or create a very few of them
Edit	...edit most AutoCAD entities, although sometimes only through the Properties panel
Create	...create many AutoCAD entities, but fewer than it can edit

See chapter 3, “Drawing File Compatibility,” for the nitty-gritty details on each DWG object.

DIVIDING WORKFLOWS BETWEEN AUTOCAD & BRICSCAD

You probably are well acquainted with your office’s *workflow*. This is the route by which drawings and associated documented flow through the office. For instance, one of my consulting clients has the following workflow:

1. Receive DWG drawing files from architects
2. Review the dimensions on received drawings for dimensional accuracy
3. Create overall elevation views of the building’s faces; make plan views of each floor
4. Draw up assembly drawings for fabricators
5. Make detail drawings of every item, then generate bills of materials
6. Plot drawings on B- or C-size paper
7. Send completed paper drawing sets to clients and fabrication shops for manufacture

As much as possible, the work is done in BricsCAD, because it operates on the majority of workstations. The only work handled by AutoCAD are design functions BricsCAD is unable to complete.

The design firm took time to list the CAD functions they employ in the office, and then created two lists:

List A: Functions that work only in AutoCAD

List B: Functions that work in both BricsCAD and AutoCAD

Here is an example of the lists they created, in which they noted the *usefulness* of functions to their workflow. Firstly, features common to both CAD systems:

Features that Work in BricsCAD and AutoCAD	Level of Usefulness
Template DWT files	Very useful for speeding up initial drawing creation
Field text	Very useful for automating text
Data extraction and spreadsheets	Very useful
Hyperlink command	Very useful for linking to other drawings
Geometric and dimensional constraints	Very useful; using dimensional constraints for sizing objects
Sheet sets	Very useful for organizing groups of drawings
Mleaders, editing, styles	Very useful for joining multiple leaders into one; and for lining up leaders neatly
DimBreak	Very useful for editing dimensions
Overkill	Useful for cleaning up drawings
LISP / AutoLISP	Useful for automating some routine drafting
CUI / Customization	Useful in some aspects, such as combining commands
Explorer / DesignCenter, Tool Palettes	Probably useful for sharing and accessing content
Drawing Views	Probably useful for generating 2D plans from 3D; firm had not yet deployed this function
Annotative scaling	Not useful
Point cloud processing	Not useful
Rendering	Not useful

And here is the usefulness rating of functions found in only AutoCAD (not BricsCAD):

Features Specific to AutoCAD	Level of Usefulness
DimSpace, DimJogLine	Very useful for editing dimensions
LayTrans command	Useful for bulk editing layer names of incoming drawings
Dynamic blocks	Useful for creating complex linetypes
Measure and Divide	Useful for placing QDim dimensions; BricsCAD lacks QDim
QDim	Useful when used with Measure; not in BricsCAD
Check Standards commands, DWS files	Too limited in scope to be useful
Active Recorder	Not useful
3D mesh and surface modeling	Not useful

Your firm's designation of useful and useless functions may differ. Concentrate on dealing with functions that are useful in the workflow; useless and limited functions can be ignored. With each release, the lists must be updated as new functions are added to both CAD systems.

STRATEGIC IMPLEMENTATION

While your firm may have several employees who are keen to implement more efficient drafting methods with BricsCAD and AutoCAD, it pays to place *one* strategic employee in charge of CAD management and training for everyone.

Here is the implementation plan that one design firm arrived at:

1. Decide on the split between the Classic, Pro, and Platinum versions of BricsCAD
2. Upgrade all Linux and Windows licenses of BricsCAD to the latest version
3. Determine a split of drafting tasks between AutoCAD and BricsCAD, recognizing the limits of BricsCAD
4. Automate 2D drafting processes as much as possible
5. As necessary, introduce a few seats of other CAD systems for handling specific 3D constructions and automated drafting of which AutoCAD and BricsCAD might not be capable
6. Establish a steering group to ensure the new techniques are disseminated throughout the firm; ensure progress is made
7. Consider hiring local trainers for specific topics; create a CAD programmer position
8. Review the implementation in a year's time

COMMON OPERATIONS THROUGH FILE PATHS

BricsCAD and AutoCAD drawings employ many support files that are identical in content. Examples of these include linetype definitions, font files, and external references. The good news is that the two can share the same support files; this reduces management complexity. The only catch is that Autodesk starts the names of many support files with *acad*, while Bricsys start with *default*; these files can be renamed.

To keep track of files logically, CAD vendors store support files in specific folders. Both CAD programs let you specify paths to these folders.

BricsCAD specifies paths in the **Program Options | Files** section of the **Settings** dialog box

AutoCAD specifies paths in the **Files** tab of the **Options** dialog box

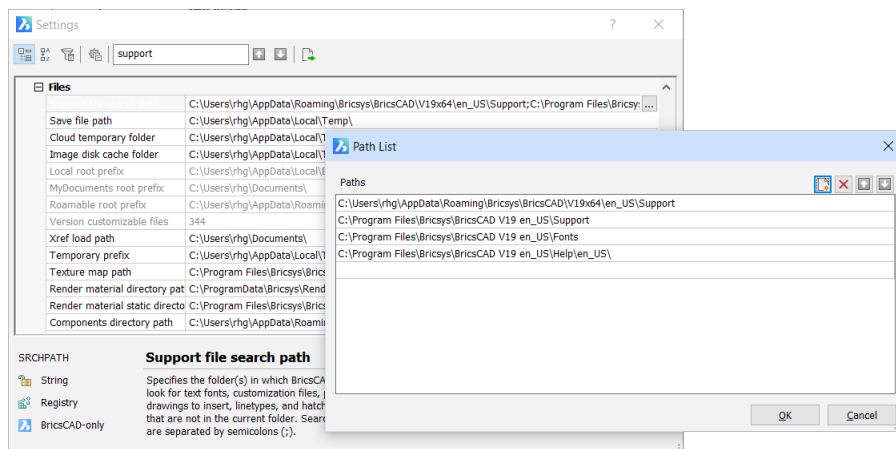

BricsCAD storing paths in the Settings | Program Options | Files section

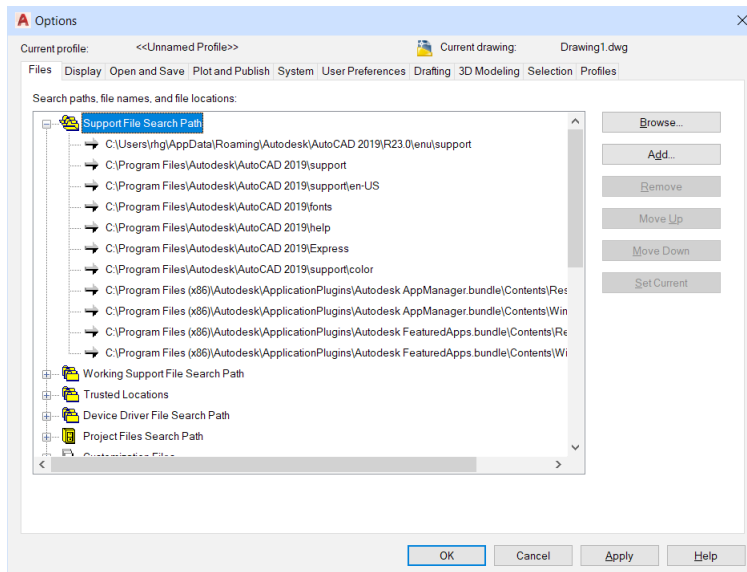

AutoCAD storing paths in the Options / Files tab

In older, simpler times, all support files were stored in a folder named `\Support`. But as Microsoft made Windows more complex, it required software makers to scatter support files into many folders for those cases when Windows computers are used by more than one user.

Local are files stored on the computer you use; these are files specific to each user and each program, such as DWG drawing files and local customization files.

LocalLow are files stored like Local files, but with a lower integrity level; used by Web browsers when Windows protected mode is on. BricsCAD and AutoCAD do not use LocalLow folders.

Common are files stored on the computer you use; these are files, such as font files and printer drivers, that are common to many programs. CAD programs make use of these files.

Temporary are files stored “anywhere,” locally or on the network; these files are created by CAD programs for the duration of the editing session, such as automatic backup files.

Roaming files are stored on any computer; these files are specific to you, such as customized linetype and hatch pattern files, and so are accessible from any networked computer. See Roamable Profiles later in this chapter.

Network files are stored on the network and are accessible to everyone, such as blocks and template files.

In Windows, support folders are usually found in a hidden folder named “AppData” under `C:\users\<login>\`, where “<login>” is the name by which you log into Windows. My login name is *rhg*, and so all of my Local, and Roaming folders are found under `C:\users\rhg\AppData`.

BricsCAD provides users with the following commands to make it easier to handle support files:

SupportFolder opens the C:\Users\<login>\AppData\Roaming\Bricsys\BricsCAD\V20x64\en_US\Support folder.

TemplateFolder opens the C:\Users\<login>\AppData\Local\Bricsys\BricsCAD\V20x64\en_US\Templates folder.

WhoHas display ownership information for a selected drawing file.

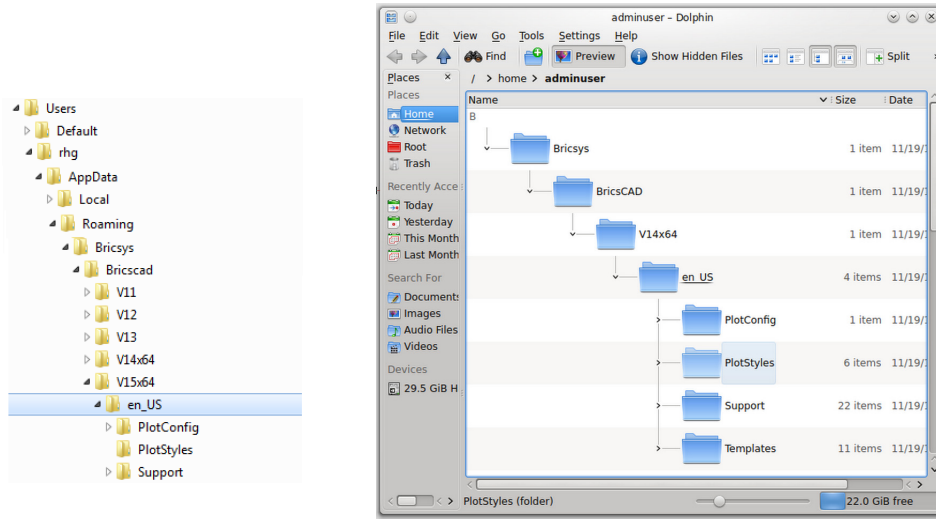

Left: Local and Roaming support folders for BricsCAD in Windows

Right: Support folders in Linux

To maintain compatibility with Windows, BricsCAD for Linux uses similar folder names and structures, although without the Local and Roaming folders. All support folders are found in this path:

`/home/<login>/Bricsys/BricsCAD/V20`

Tutorial: How to Add AutoCAD Support Folder Names to BricsCAD

If AutoCAD is installed on the same computer as BricsCAD, then you can point BricsCAD's support paths to AutoCAD's folders. This is a brilliant way for your office to use common files for both programs, such as hatch patterns, linetypes, and fonts.

To use AutoCAD's support files in BricsCAD, enter the **Settings** command, as follows:

1. Start BricsCAD, and then enter the **Settings** command.
2. In the Search field, enter "support file".

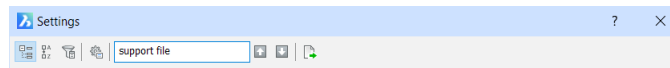

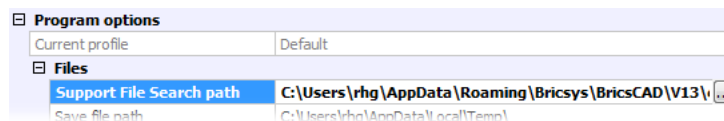

Searching for the phrase "support file"

Notice that the Settings dialog box jumps to the **Support File Search Path** item.



The support file search path entry in the Settings dialog box

3. Click the  **Browse** button to open the Folders List dialog box.
4. In the Folders List dialog box, click  **Add Path**.

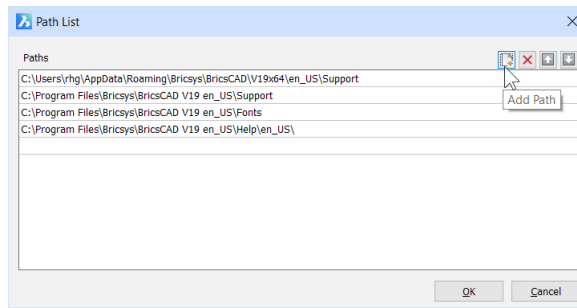

Adding paths to BricsCAD's search path

5. A blank line is added, as shown below. Click  **Browse** to look for the paths to add.

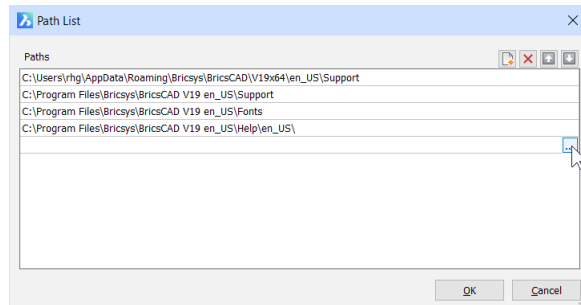

Clicking the Browse button

6. In the Choose a Folder dialog box, navigate to the AutoCAD folder you wish to add, and then click **OK**.

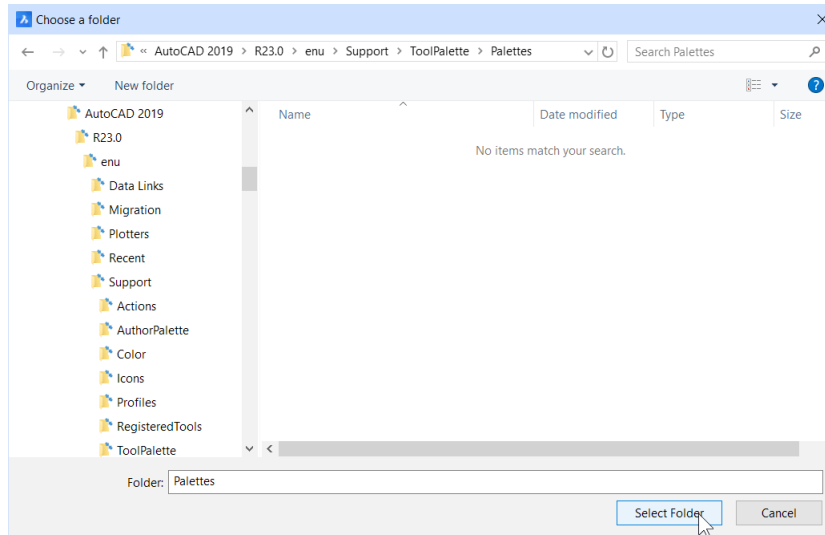

Selecting a folder to add to the search path

Notice that the folder is added to the list.

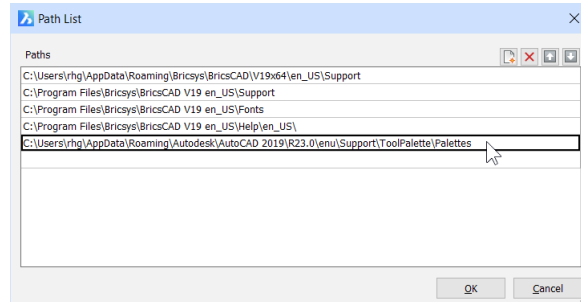

New folder added to the search path

7. Repeat the process to add the locations of other support folders, such as these:
 - ▶ DWT drawing template files at C:\Users\<login>\AppData\Local\Autodesk\AutoCAD 2018 - English\R22.0\enu\Template
 - ▶ Most other support files at C:\Users\<login>\AppData\Roaming\Autodesk\AutoCAD 2018 - English\R22.0\enu\Support
8. When done, click **OK**.

TIP You can do the same process in AutoCAD: use its **CUI** dialog box's Files tab to point it to BricsCAD support folders.

USER PROFILES

BricsCAD and AutoCAD both support *user profiles* that store each user's customization settings. After changing settings with the BricsCAD **Settings** and AutoCAD **Options** commands, you save the settings in a *.arg* user profile file. The idea here is that the CAD manager makes multiple profiles to customize each CAD program for different users and for specific projects.

Profiles are made differently in each CAD package:

BricsCAD creates user profiles through an external application, *UserProfileManager.exe*

AutoCAD creates user profiles through the Profiles tab of the Options dialog box

To access BricsCAD's UserProfileManager program:

- ▶ In Windows 7, click **Start** button, and then choose **All Programs | Bricsys | BricsCAD V20 | User Profile Manager**
- ▶ In Windows 8 and 10, press **Windows+Q** and then enter "user profile manager" in the **Search** field

- ▶ Or access it from inside BricsCAD by entering the **ProfileManger** command

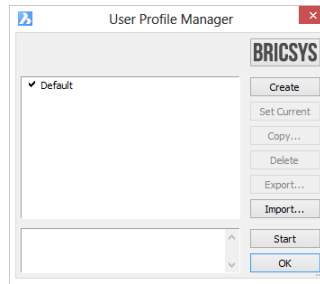

User Profile Manager is a stand-alone program with BricsCAD

- ▶ To save the current user interface configuration, click **Create** and then give the profile a name.
- ▶ To switch to another profile, choose it from the list, and then click **Set Current**.
- ▶ To read an *.arg* file from AutoCAD, click **Import**.

Launching BricsCAD with a User Profile

To launch BricsCAD with a specific user profile, add the **/p** switch to the desktop shortcut's properties:

1. To access the properties, right-click the BricsCAD shortcut icon on the desktop, and then choose **Properties** from the shortcut menu.

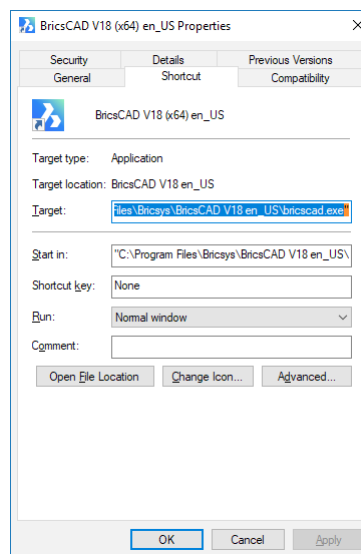

2. Edit the **Target** field to look like this (changes shown in blue):
"C:\Program Files\Bricsys\BricsCAD V20\bricscad.exe" /P <UserProfileName>

For example, replace <UserProfileName> with the *.arg* file's name, such as *myprofile.arg*:

"C:\Program Files\Bricsys\BricsCAD V20\bricscad.exe" /P *myprofile.arg*

3. Click the **OK** button to close the dialog box.

Now when the icon is clicked, it starts BricsCAD with the specified profile.

Tutorial: How to Import AutoCAD Profiles into to BricsCAD

Both programs use the same format for *.arg* files, and so you can import AutoCAD-generated profiles into BricsCAD. Follow these steps to export and import them.

Firstly, export the *.arg* file from AutoCAD, as follows:

1. In AutoCAD, enter the **Options** command, and then click on the **Profiles** tab. (See figure above.)

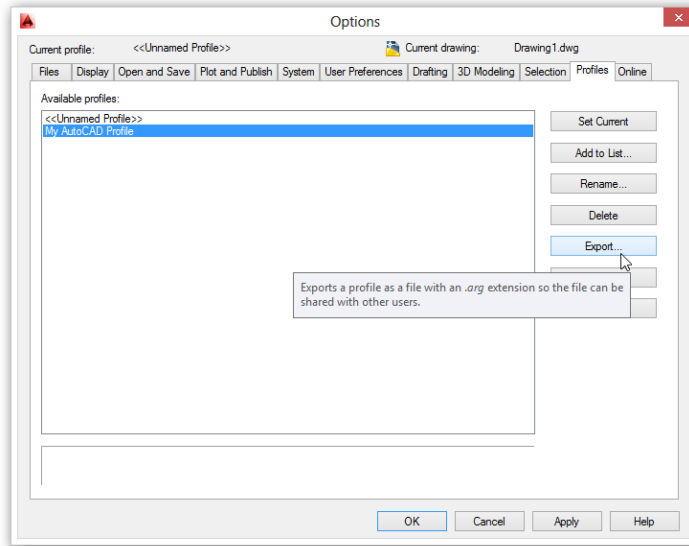

Exporting a user profile from AutoCAD

2. Choose a profile from the list, and then click **Export**.
3. Select the folder into which profile file should be saved. If you wish, change the file name.
4. Click **Save**.
5. Click **OK** to exit the dialog box.

Secondly, import the *.arg* file to BricsCAD:

1. In BricsCAD, from the **Tools** menu, choose **User Profile Manager**.
2. In the User Profile Manager, click **Import**.
3. Choose the *.arg* file exported from AutoCAD, and then click **Open**.
4. To apply the profile, click **Set Current**.
5. Click **OK** to exit the program.

ROAMING PROFILES

BricsCAD and AutoCAD both support *roaming profiles*, which let you “roam” about and use the CAD program on any computer connected to the office network. Your profile is identified automatically by the login name you entered when you accessed the computer. The benefit is that BricsCAD and AutoCAD are customized automatically with your settings.

Not all CAD files are roamable; some remain local, such as DWT template files. This is why roaming and non-roaming (local) files are kept in separate folders. It is up to the software maker to decide which are which.

AutoCAD Support Folders

AutoCAD’s nonroamable (local) files are in `C:\Users\<login>\AppData\Local\Autodesk\AutoCAD\R22.0\enu` and consist of the following files:

- ▶ Template files (DWT, DST, DGN)
- ▶ Web Services

AutoCAD’s roamable files are in `C:\Users\<login>\AppData\Roaming\Autodesk\AutoCAD\R22.0\enu` and consist of the following files:

- ▶ Data links
- ▶ Language packs
- ▶ Migration
- ▶ Plot styles (CTB, STB), plotter parameters (PMP), and plotter configurations (PC3)
- ▶ Support files (CUIX, FMP, LIN, MLN, MNL, PAT, PGP, PSF, UNT, and so on)

BricsCAD Support Folders

BricsCAD’s nonroamable (local) files consist of the following ones:

- ▶ Template files (DWT)

The files are found by following these OS-specific paths:

Windows	<code>C:\Users\<login>\AppData\Local\Bricsys\BricsCAD\V20x64\en_US</code>
Mac	<code>/users/<login>/Library/Prferences/Bricssys/BricsCADV20x64/en_US/</code>
Linux	<code>home/<login>/Bricsys/BricsCAD/V20x64/en_US/</code>

BricsCAD’s roamable files consist of the following ones:

- ▶ Plot styles (CTB, STB), and plotter configurations (PC3)
- ▶ Support files (CUI, FMP, LIN, PAT, PGP, PSF, UNT, and TXT)

Bricsys files are found by following these OS-specific paths:

Windows	<code>C:\Users\<login>\AppData\Roaming\Bricsys\BricsCAD\V20x64\en_US</code>
Mac	<code>/users/<login>/Library/Prferences/Bricssys/BricsCADV20x64/en_US/</code>
Linux	<code>home/<login>/Bricsys/BricsCAD/V20x64/en_US/</code>

You can change in BricsCAD the path to local and roamable folders with system variables **LocalRootPrefix** and **RoamableRootPrefix**. This is useful when the content of the folders is stored on a central server.

Tutorial: Importing Menu Files from AutoCAD

If you have menus that you customized in AutoCAD, then you can probably use them in BricsCAD. Follow these steps to import menu files from AutoCAD:

1. Use the **Customize** command to open the Customize dialog box.
2. At the right end of **Main Customization File** field, click the  button.
3. In the Select Main CUI File dialog box, click the **Files of Type** droplist.

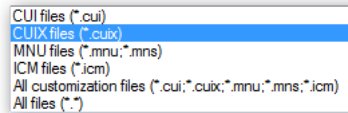

Selecting a menu file type to import

Notice the list of file types:

- ▶ **CUIX** — compressed CUI files that also store resources, like icon files; in use by AutoCAD since release 2012 and by BricsCAD since V14
 - ▶ **CUI** — standard menu files used by AutoCAD since release 2007 and by BricsCAD since V8
 - ▶ **MNU** or **MNS** — legacy menu and support files used by AutoCAD and by AutoCAD LT prior to release 2007
 - ▶ **ICM** — IntelliCAD menu files used by BricsCAD prior to V8 and by IntelliCAD-based systems
4. Choose a file type, select a file name, and then click **OK**. Notice that the menu structure changes to match the newly-imported file.

Careful! Although BricsCAD imports AutoCAD menu files effortlessly, menu actions sometimes do not work, because AutoCAD macros can contain macro code or metacharacters not supported by BricsCAD.

Tutorial: Making Hidden Folders Visible in Windows

Local and roaming folders can be difficult to find, because they are, unfortunately, typically hidden by Windows and MacOS. (They are not hidden in Linux.) Because I access them frequently, I unhide the folders.

If you find yourself accessing these folders often, create shortcuts on your computer's desktop. Here's how: hold down the **Ctrl+Alt** key while dragging the folder name from Explorer onto the desktop.

Here is how I do this in Windows:

1. First, make *all* hidden folders visible by following these steps:
 - a. In Windows, open File Explorer, and then choose Options:
 - Windows 7: from the Tools **menu**, choose **Folder Options**.
 - Windows 8.x and 10: choose the **View** tab, and then from the Show/Hide panel, click **Options**.

- b. In the dialog box, choose the **View** tab,
- c. Under Advanced Settings, turn on **Show Hidden Files and Folders**.

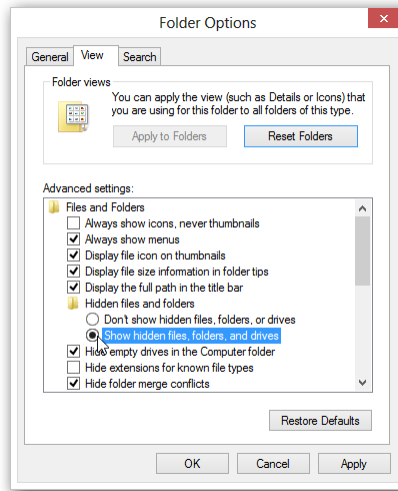

Accessing the option to reveal hidden folders

2. Now that hidden folders are visible, follow these steps in Explorer:
 - a. Go to the C:\users\ - b. Right-click the folder, and then choose **Properties**.
 - c. Uncheck **Hidden**, and then click **OK** to close the dialog box.

You can now see the Local and Roaming folders.

Tutorial: Making Hidden Folders Visible in MacOS

The Library folder is where BricsCAD stores its support files on Mac computers. Here is how to reveal the folder in MacOS:

1. Open Finder, and then navigate to your user folder. In my case, it is “ralphg.”
2. From the **View** menu, choose **View Options**.
3. In the dialog box, notice that the **Show Library Folder** option is turned off. Click it to turn it on.

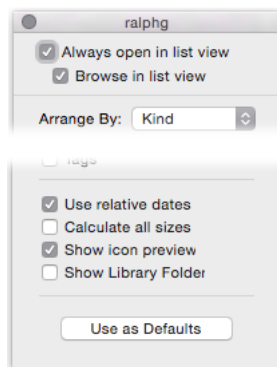

Unhiding hidden folders in MacOS

4. Close the dialog box. Notice that the Library folder is now visible.

Tutorial: Loading AutoCAD's PGP File into BricsCAD

The PGP file holds alias abbreviations for command names. If you have customized aliases in AutoCAD, then you can use them in BricsCAD.

Here is how to load the PGP file from AutoCAD into BricsCAD:

1. Use Windows Explorer to copy the *acad.pgp* file **from** this folder:
`C:\Users\<login>\AppData\Roaming\Autodesk\AutoCAD\R22.0\enu\Support`
2. Rename it *default.pgp*.
3. Place the renamed file in the appropriate BricsCAD folder:
 - ▶ **Windows** `C:\Users\<login>\AppData\Roaming\Bricsys\BricsCAD\V20x64\en_US\Support`
 - ▶ **MacOS** `/Users/<login>/Library/Preferences/Bricsys/BricsCAD/V20x64/en_US/Support`
 - ▶ **Linux** `home/<login>/Bricsys/BricsCAD/V20x64/en_US/support`(Remember to replace <login> with your Windows login name.)

It turns out that in BricsCAD you cannot simply use the Customize dialog box's **Program Parameter File** field, because it does not allow you to enter a different path.

To transfer files from a Windows computer to a MacOS or Linux computer, use a USB thumbdrive or a file transfer service like Dropbox.

Tutorial: How to Export AutoCAD Palettes to BricsCAD

If you have customized the content of AutoCAD's Tools Palette, then you can use them in BricsCAD, because they use the same *.xtp* file format for exporting and importing palettes. XTP is short for "xml tool palettes," and is a file format based on XML, a self-documenting version of HTML that is often used in data exchange situations.

To import palette files from AutoCAD to BricsCAD, follow these steps:

1. Start AutoCAD, and then enter the **Customize** command.
2. In the Customize dialog box, right-click the palette you want to export. From the shortcut menu, choose **Export**.

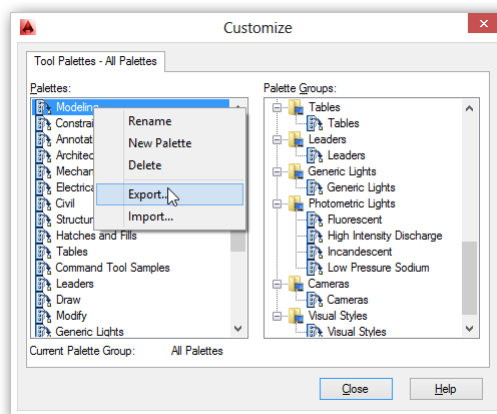

Choosing palettes to export from AutoCAD

3. In the Export Palettes dialog box, choose the folder in which to place the exported XTP file, and then click **Save**. (I tend to use the Desktop, because it is easy to find later!)
4. Switch to BricsCAD.
5. Right-click the Tools Palette bar, and then choose **Customize Palettes**.

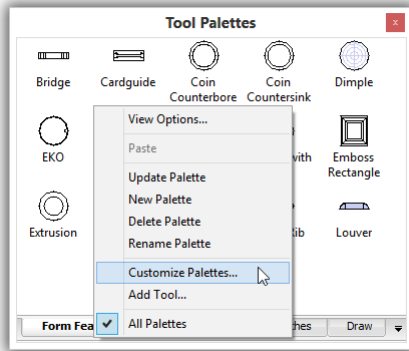

Accessing the Customize dialog box in BricsCAD

6. In the Customize dialog box, right-click any palette, and then choose **Import** from the shortcut menu.

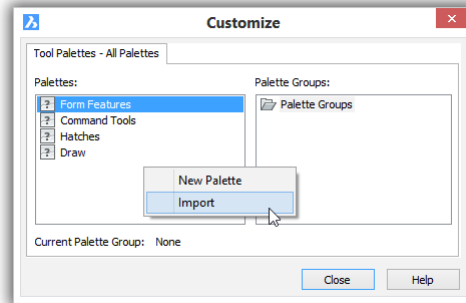

Importing .xtp files into BricsCAD

7. In the Import Palettes dialog box, choose the XTP file you exported from AutoCAD, and then click **Open**. Notice that it is added to the list of Palettes.
8. Click **Close**. Notice that the Tool Palettes bar now has a new tab named after the palette you imported. The icons will probably consist of ?, because the icon files are unavailable.

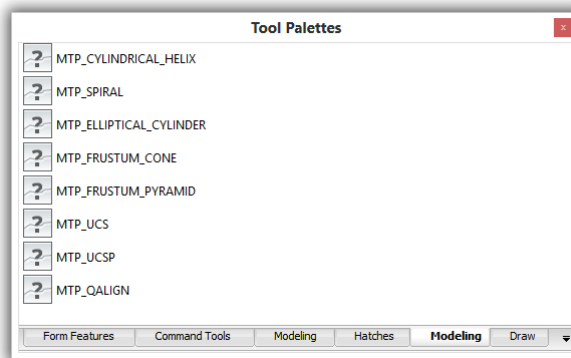

Icons missing from imported AutoCAD tools palette

9. Click an icon; notice that the command (probably) works!

The Dual OS Office

To further save money, some firms switch some of their workstations from Windows to Linux. One firm told me that replacing Windows with the free Linux operating system saves them 10% of their annual IT budget.

AutoCAD is not available for Linux, but BricsCAD is. Bricsys is working hard to ensure that nearly all of the features in the Windows version operate properly in the Linux version.

Autodesk has a version of AutoCAD for MacOS computers, but it has only about 85% of the commands found in the Windows version. Bricsys now ships their MacOS version just after the Windows version comes out.

Here are the comparison charts from each CAD vendor for the functions included with the various operating systems:

AutoCAD Windows vs Mac: <http://www.autodesk.com/products/autocad/compare/compare-platforms>

BricsCAD Windows and MacOS vs Linux: <https://www.bricsys.com/en-intl/bricscad/compare/>

SOLVING THE PROBLEM OF PORTING SOFTWARE TO LINUX

Porting is the term used to describe the process of making a software program work correctly with another operating system. The part of the CAD system that deals with geometric objects is not a problem in porting. The problems lie behind the scenes, specifically in the areas of programming interfaces and user interface elements.

Even for a large, wealthy firm like Autodesk, porting CAD programs to other operating systems is a difficult undertaking, because most of today's CAD software is intimately intertwined with the Windows operating system. Microsoft deliberately made it easy for programmers to write software for Windows, but then came the cost of making it excruciatingly difficult to tear away from Windows. For instance, a programming team at Autodesk took 18 months to rewrite AutoCAD for MacOS, and even then something like 30% of commands were left out of the initial release, as were most programming interfaces for third-party programmers.

Admittedly, ten years ago, no CAD programmer would have dreamed of writing code for anything other than Windows. Or perhaps for MacOS. (A few CAD firms, such as Graphisoft and Vectorworks, began on the Macintosh computers more than twenty years ago, and since then developed their software simultaneously for MacOS and Windows. This foresight means no pain for them today!) Now, however, the plausible choices have quadrupled to include Android and iOS on portable devices, and Linux and MacOS on desktop systems — in addition to Windows on desktop and portable devices.

User Interface

To fix the two problems, Bricsys undertook a significant programming project. First, they rewrote the user interface using wxWidgets (<http://www.wxwidgets.org>). This interface allows BricsCAD to look the same on Linux, MacOS, Windows, and mobile operating systems.

“How should a ported program look?” This serious question faces software companies: should a CAD program look the same on all operating systems? If so, then current users feel comfortable switching. This is the approach Bricsys took, and so the Linux version looks the same as the Windows version.

Or should the CAD program look like the host operating system? If so, then new users feel comfortable starting with it. This is the approach Autodesk took with AutoCAD for Mac, which looks like a program written for MacOS, different from the Windows version.

APIs

A second project was even more difficult: mimicking the Windows programming interface, something that no other CAD vendor attempted. (In the general computing world, there have been efforts like those of Wine, VMware, and Win4Lin to help Windows programs run on Linux and MacOS.) Programmers at Bricsys had to write the code for Linux that Microsoft normally provides for Windows.

Note that this problem affects only the parts of programming languages that depend greatly on the underlying operating system, such as Visual LISP, .Net, and ARX or BRX. The OS problem does not affect customization internal to the CAD system, such as menu and toolbar macros, LISP routines, and scripts.

The end result ensures that add-ons written in Windows and Mac work in Linux . Here is a list of the APIs that Bricsys ported to BricsCAD for Linux:

- All **LISP** functions, excluding VL, VLA, VLAX, and VLR functions, because they depend on Windows-only COM

- All **DCL** functions

- All **DIESEL** functions

- All **TX** functions

- All **BRX** functions, excluding interfaces that are strongly tied to Windows, such as AcUi/AdUi and OPM categories

- All **SDS** functions, excluding Windows-specific types

The **RecScript** command (script recorder) in BricsCAD produces .scr files that can be edited, which makes it more useful than the Action Recorder in AutoCAD. Since the Action Recorder's “scripts” cannot be edited, it is not really an API.

BENEFITS OF LINUX

Running the Linux operating system on computers instead of Windows has several benefits. These include the following items.

Linux is Free

Linux is free, as are subsequent upgrades. While Windows is included “free” with every new computer (actually, you pay a hidden cost of about \$20), upgrades are not free. Upgrading from older versions of Windows can cost \$40 to \$200 per computer, depending on current offers available. Microsoft and Apple provide their operating system upgrades free, Microsoft with Windows 10.

Desktop Linux is now similar enough to regular Windows that some users cannot tell the difference. This is particularly true for those users who don’t care about the UX (user experience), but instead care primarily about getting the work done. Once inside BricsCAD, the Linux version looks almost identical to the Windows version. Indeed, CAD operators at one design firm subsequently asked the IT staff to install Linux on their home computers, after experiencing its benefits at work.

Linux is Hardware-Efficient

Linux runs more efficiently than Windows. This means it can run CAD software faster on older hardware for more years than does Windows. Whereas Windows today can barely function on computers with “just” 1GB RAM, Linux has no problem with small amounts of memory. The problem occurred, because Microsoft programmers were instructed by founder Bill Gates to assume computers have infinite memory and CPU speeds, which they do not. As a result, Windows to this day is written inefficiently.

In contrast, Linux is based on Unix, an operating system from the 1970s, which was written with ultra-efficiency to run well on computers with very little memory and very slow CPUs. The ethos of efficiency has carried successfully into our current decade.

Linux Is Malware-free

Linux has fewer irritants than Windows and Mac MacOS. It does not suffer from malware attacks, such as viruses, since the number of Linux computers is too small for virus writers to bother with.

My favorite feature about Linux is that after updates are applied to Linux, I do not need to reboot the computer as I do with Windows or MacOS; I keep right on working. Even though Apple based MacOS on Unix, I am surprised that MacOS needs reboots following updates.

Here’s a funny thing I have noticed: it is easier to get used to MacOS when you are already familiar with Linux, than coming directly from Windows.

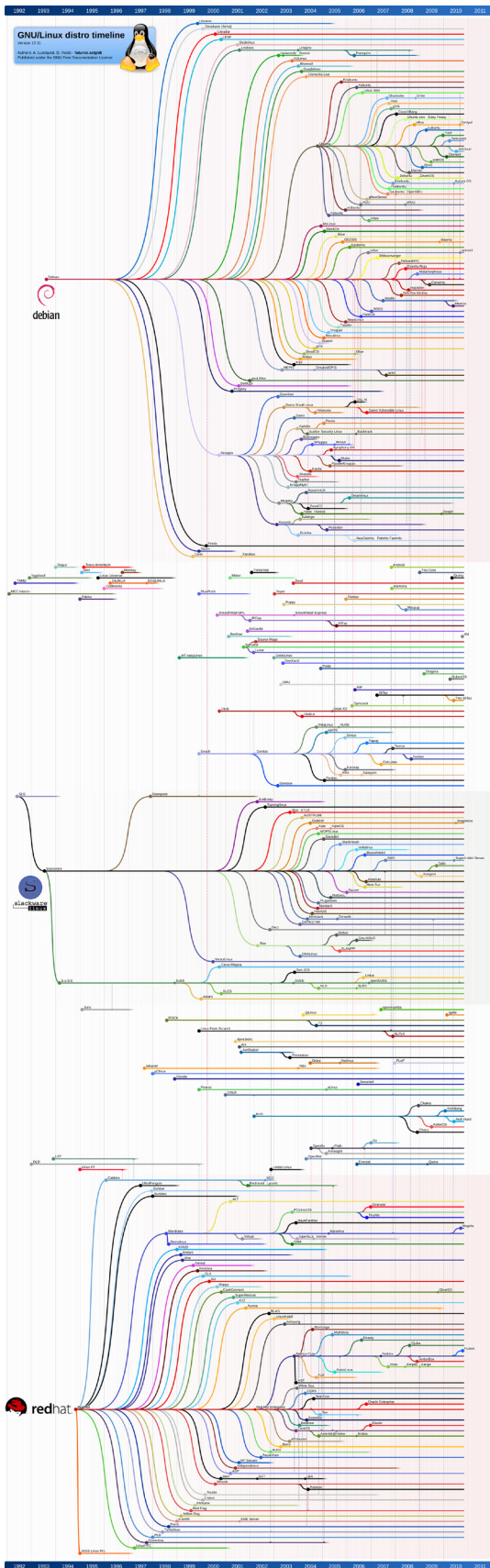

Linux is Hardware-compatible

Linux runs on the same computers as Windows, unlike MacOS, which is locked to Apple hardware. To try out Linux, you can install it on an existing Windows computer; to try out MacOS, you have to buy all new hardware, and get used to different keyboard and trackpad interactions.

(A tip: If you have to get MacOS, save some money by buying the Mac mini with the maximum amount of RAM available, and then hook up your own monitor, keyboard, and mouse. I find the mini is more flexible than the MacBook.)

Linux Dual-boots

Linux has dual-booting built-in, unlike Windows. This means that one computer can run both Linux or Windows, through not simultaneously. When the computer starts, a Linux utility called “grub” lets you choose between running Linux or Windows. MacOS also includes a dual-boot facility, called BootCamp for running Linux or Windows.

If instead you wish to run two (or more) at the same time (as I do), then you can use a free virtual manager program, such as Oracle Virtual Box (<http://www.oracle.com/technetwork/server-storage/virtualbox/downloads/index.html#vbox>). This program lets you run, say, Linux in a window (or full screen) inside Windows or MacOS, and even copy and paste between them.

DRAWBACKS TO LINUX

Linux never conquered the desktop the way it took over in all other areas of computing, such as Web servers, mainframe computers, smartphones, and embedded computing. Microsoft’s monopolistic practices for many years were effective in locking out competitors, such as Apple and Linux.

Linux is confusing, because it can feel different from Windows, it has hundreds of versions and several graphical user interfaces from which to choose, and can sometimes have problems installing software.

Because it is different, it does not always have all the same software that Windows users are used to. Because there is so much choice in the number of versions of Linux, users can end up making no choice. And when software won't install, you won't use it.

Lack of Identical Software

Much of the basic software you run on Windows is available on Linux, such as Libre Office, which runs identically on Linux, MacOS, and Windows. If you use Microsoft Office on Windows, then you'll be running Libre Office on Linux. Other basics are also available in multi-OS versions, such as Web browsers (Chrome, Firefox, and Opera), music and video playback (VLC), and Skype.

Linux comes with a ton of utilities; after all, it was written by geeks for themselves. For instance, the built-in screen grab software is much more sophisticated than the one for Windows or MacOS.

But it cannot run AutoCAD and other powerhouse software found in Windows and MacOS, such as PhotoShop and InDesign — except through a Windows emulator, such as Wine. I find that emulators are not efficient (runs the software slower), are not 100% compatible (some software and some software functions don't operate), and development is patchy.

I recommend using native software, and I would rather do without than run software in an emulator or in a virtual machine. In this case, BricsCAD for Linux becomes the obvious choice.

Which Linux?

There are many more versions of Linux than there are of Windows. There is the source version written by Linus Torvald, after whom Linux is named. Then there are primary distributions, with names like Debian, Ubuntu, Gentoo, Fedora, Red Hat, Mandriva, and Slackware. See figure at left.

For every primary distribution, there are dozens of variants. This page at Wikipedia lists the names of more than 100 distributions and variants: http://en.wikipedia.org/wiki/List_of_Linux_distributions.

So, it can be hard — no, confusing — to choose one. In one way, it does not matter, since they all operate pretty much in roughly the same way; indeed, they work similarly to Windows and even more similarly to MacOS.

Because they are free, you can download a bunch of them and try them out. Downloads are often available as LiveCD format. You download the file (in *.iso* format), which you burn to a CD, and then you can run Linux from the CD drive and/or install onto a computer. In this case, I recommend using a virtual machine (VmWare or Virtual Box) to install a Linux distribution temporarily, unless you have a computer whose hard drive you can wipe. (You can run Linux off a CD or USB stick, but then it runs slowly, and you get a bad first impression!) Here is a list of downloadable LiveCDs that contain Linux: https://en.wikipedia.org/wiki/List_of_live_CDs.

As for me, I use Mint Linux. It is based on the most popular dialect of Linux, Ubuntu, and so it can use *.deb* (Debian) installation files designed for Ubuntu. Better than just Ubuntu, however, Mint

includes all the extras that make starting out with Linux less painful, such as common applications, drivers, and codecs. Download it free from <https://www.linuxmint.com>. For a version that runs in VirtualBox, see <http://www.osboxes.org/linux-mint>.

Problematic Installers

The biggest headache for new and medium-term Linux users is installing software. Many times, installing software goes without a hitch; other times, it does not work well and is a major pain. The problem exists because Linux first expected users to install software through the command-line interface; later, a GUI was added, and then different distributions came up with different ways of making installs easier. When you have hundreds of versions of Linux, you're bound to end up with dozens of installers. Someone once said in another context that more choice leads to less stress, but I disagree.

Major Linux vendors and software providers are fixing the problem in two ways: (a) through Windows-like installers, which operate nearly automatically; and (b) through MacOS-like software libraries built into the operating system.

Here is a list of the major distributions and the installer software they use:

Linux Distribution	Package File	Package Manager
Debian GNU/Linux	.deb	dpkg
Fedora Linux	.rpm	RPM
OpenSUSE Linux	.rpm	RPM
Others	.tgz	tar

If the variant you used is based on Debian, then you click the DEB file button. I use Mint Linux, which is based on Ubuntu, which is based on Debian, and so I download *.deb* files.

Competing GUIs

If you have hundreds of dialects of Linux, then you are going to have several user interfaces. That's right: Linux offers easily replaceable graphical user interfaces. (This is also possible in Windows, but few have any desire to change Microsoft's design.)

There used to be a big split over which interface to use with Linux: KDE or Gnome. (I prefer Gnome.) Today, there is also Unity, which is designed for the smaller screens of netbooks and portable devices.

— — —

This chapter provided you with practical advice on running a design firm with both AutoCAD and BricsCAD, along with the pros and cons of replacing Windows with the Linux operating system.

Working With Advanced 3D

BRICSCAD PRO IS PRICED LIKE AUTOCAD LT, YET IT PERFORMS ADVANCED 3D MODELING with functions not found in even full-priced AutoCAD. How is this possible? Here are some of the reasons:

- ▶ Autodesk as a shareholder-owned company has high operating expenses, and it must generate an ever larger income for shareholders
- ▶ Bricsys arranges its affairs to be a lean corporation
- ▶ AutoCAD cannot compete against other software from Autodesk, like Inventor and Revit
- ▶ BricsCAD does not have to compete against other Bricsys software

The result is that over time BricsCAD gains more functions even as Autodesk pulls back on development of AutoCAD. As this chapter illustrates, BricsCAD Pro and Platinum have remarkable 3D capabilities:

- ▶ Direct modeling (press-pull)
- ▶ Quad cursor *, manipulator (gizmo), HotKey Assistant widget *, and 3D mouse
- ▶ 3D geometric constraints* and 3D dimensional constraints *
- ▶ Design intent *
- ▶ Mechanical browser, materials, and hardware library *
- ▶ Surface modeling
- ▶ Sections
- ▶ Generative drafting (model documentation)
- ▶ Bills of material (data extraction)
- ▶ 3D compare *
- ▶ **(new in V20)** Parts animation of assemblies *

* Functions not found in AutoCAD

See Chapters 7 and 8 for information on the editions of BricsCAD for doing 3D modeling in BIM and Mechanical, as well as Communicator for translation.

3D FUNCTION COMPARISON

The table shows the BricsCAD edition in which 3D functions are found, and whether AutoCAD has similar functions.

	BricsCAD for Windows			BricsCAD for Mac & Linux			AutoCAD	LT
	Platinum	Pro	Classic	Platinum	Pro	Classic		
3D Compare	•			•				
3D Geometric constraints	•			•				
3D Surfaces	•	•	•	•	•	•	•	
3D Mesh modeling							•	
ACIS modeling and editing	•	•		•	•		•	(1)
ACIS viewing	•	•	•	•	•	•	•	•
Animation of parts	•			•				
Assembly modeling and editing	•			•				
Assembly viewing	•	•		•	•			
Automatic balloons	•	•		•	•			
Bills of material	•			•			•	
Deformation modeling	•			•			•	
Design intent	•			•				
Design tables	•	•		•	•			
Direct modeling	•	•		•	•		•	
Generative drafting	•	•					•	
Hardware library	•	•						
Kinematic analysis	•			•				
Mechanical browser	•			•				
Section planes	•	•		•	•		•	
Surface modeling and lofts	•			•			•	
BIM modeling	Add-on			Add-on				
Import-export MCAD files	Add-on	Add-on		Add-on			•	
Sheet metal design	Add-on			Add-on				
Rendering	•	•		•	•		•	
Visual styles	•	•	(1)	•	•	(1)	•	
Walkthrough navigation	•	•	•				•	
3D mouse	•	•	•				•	•
Manipulator widget	•	•	•	•	•		•	
HotKey (Ctrl function) widget	•	•	•					

If you find that some commands don't work, then there are two reasons possible: you are running a lower edition of BricsCAD, such as Pro or Classic; only the Platinum edition has all commands described in this chapter.
If with Platinum you still cannot access some commands, perhaps **RunAsLevel** is changed. Its purpose is to simulate lower editions of BricsCAD. Enter **runaslevel**, then change the value to **2**.

(1) Limited in function

BricsCAD's Direct Modeling vs AutoCAD's PressPull

BricsCAD can open 3D models made in AutoCAD, and then edit them. BricsCAD stores everything in DWG files, like AutoCAD. BricsCAD uses the ACIS modeler licensed from Dassault Systemes Spatial, while AutoCAD uses ShapeManager, an offshoot of ACIS. BricsCAD provides a large set direct modeling commands. This table compares which ones are also available in AutoCAD:

BricsCAD Direct Editing Operations	Equivalent in AutoCAD
dmChamfer chamfers edges	Chamfer
Copy copies parts and sub-entities	Copy
dmCopyFaces copies features (holes, ribs) to 3D solids	...
bmCreateComponent create components from selection sets	...
dmDeformCurve moves or rotates edges to target curves	...
dmDeformMove moves or rotates edges	...
dmDeformPoint transforms points lying on specified faces	...
dmDelete erases parts and sub-entities	Erase
dmExtrude extrudes planar entities and sub-entities	Extrude
dmFillet rounds edges	Fillet
Loft creates lofts from curves	Loft
dmPushpull pushes and pulls faces and closed contours	PressPull
dmSimplify removes unnecessary edges and vertices, merges seams	...
dmSimplifyAll also unnecessary elements in xrefs	...
dmStitch converts watertight region and surface entities to 3D solids	...
dmRevolve revolves planar entities and sub-entities	...
dmRigidSet3D turns components into a rigid set, like a group	...
dmTwist twists 3D objects along an axis	...
Modeling Assistance	
3dCompare compares differences between two models	...
dmAudit checks and fixes 3D models	...
dmAuditAll also checks and fixes 3D ACIS models in xrefs	...
bmBom inserts bills of material (BOM) tables into drawings	...
bmBomPanelOpen configures bills of materials	...
dmDistance3d measures nearest points on boundaries, central points, or axes of geometry on cylinders, circles, and spheres	...
dmGroup creates new groups, edits, and dissolves groups	Group
dmRepair checks, reports, and optionally fixes errors in 3D solids	...
dmSelect selects 3D subentities (edges, faces, protrusions, fillets)	Select
dmSelectEdges places faces and solids in a selection set	...
dmThicken converts surface to 3D solids with specified thicknesses	...
Ucs locates the UCS icon on entities	DUcs
dmUpdate updates 3D models to satisfy constraints	...
Help searches for help topics at the command line	Help

Boolean Operations

Subtract subtracts one ACIS solid from another	Subtract
Union joins one ACIS solid with another	Union
...	Intersection

Kinematic Operations

AnimationEditorOpen creates parametric animations	...
dmMove moves parts and sub-entities	...
dmRotate rotates entities and sub-entities	...

WORKING WITH DIRECT MODELING

Direct 3D modeling is the kind of modeling with which AutoCAD users are probably familiar. It has been part of the venerable CAD program ever since solid modeling was introduced to Release 13 in 1994. “Direct modeling” creates and edits 3D objects with no thought of their *history*. “History” is a record of the order in which the parts are made and edited, and the commands with which the 3D models are constructed.

History-based modeling is the norm in MCAD packages like Inventor (from Autodesk) and Solidworks (from Dassault Systemes). The granddaddy of them all is Pro/Engineer (from PTC) being the first to popularize history-based parametric modeling in the late 1980s. While history-based modeling has proven to be beneficial in keeping track of the designer’s intentions, the drawback is that large models become unwieldy to edit and can even crash as the entire history tree must be updated with every change.

As computers became faster, however, CAD firms were able to implement direct modeling in a more powerful manner, and so it was re-popularized through a new breed of programs, like SpaceClaim and IronCAD. Old software firms like Autodesk and PTC also released new direct modeling software, with New Age names like Fusion and Creo, respectively.

BRICSCAD COMMAND NAME PREFIXES

Bricsys uses a number of prefixes to identify the purpose of special command names:

- ▶ **bim** BIM (building information modeling) commands, such as `bimClassify`
- ▶ **bm** BricsCAD Modeling commands, such as `bmInsert`
- ▶ **cloud** Commands for accessing Bricsys 24/7, the online site
- ▶ **dm** Direct Modeling commands, such as `dmRepair`
- ▶ **gc** Geometric constraints commands, such as `gcFixed`
- ▶ **sm** Sheet Metal commands, such as `smLoft`

Bricsys rides the wave made possible by new algorithms, and so direct modeling is available in Pro and Platinum editions of BricsCAD, along with design intent and parametrics — everything, but the history tree. Leaving out history was a deliberate design decision by the company. BricsCAD works with all solids, including those imported from other MCAD systems.

Accessing Direct Modeling Commands

- ▶ Enter commands that start with ‘dm’.
- ▶ In the **Model** menu, choose the **Direct Modeling** submenu
- ▶ Open the **Direct Modeling** toolbar and then chose a command



- ▶ In the ribbon’s **Model** tab, look for commands in the **Direct Modeling** panel (Modeling workspace).

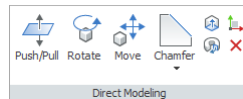

Use the **dmStitch** command to covert regions to surface objects.

Direct Modeling Tutorial

To see how direct modeling works in BricsCAD, we’ll design a lid for a storage container. The lid is 75mm round and 16mm tall. The smaller stopper portion is 65mm round x 8mm tall, and has a fillet.

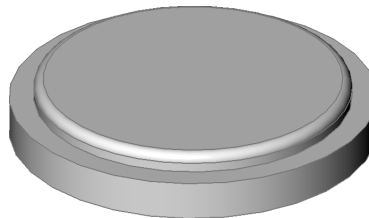

Finished 3D model of a lid

1. Start BricsCAD with a new drawing by choosing “Modeling”.

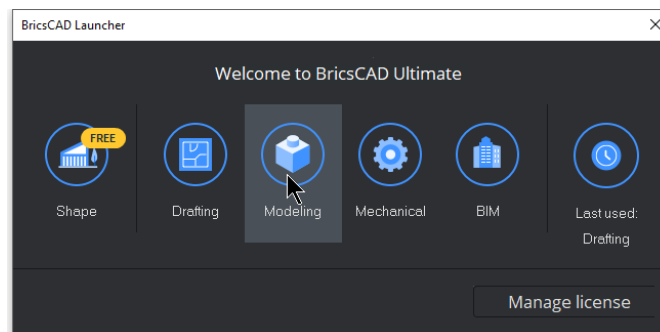

Starting a new drawing in the Modeling workspace

(If you are already in BricsCAD, then switch to **Modeling** workspace: right-click the workspace name on the status bar, and then choose “Modeling” from the shortcut menu.)

2. Draw the base of the lid as a circle 75mm in diameter, as follows:

```
: circle
```

```
Select center of circle or [2Point/3Point/TTR/Arc/Multiple]: (Pick a point in the drawing)
```

```
Set Radius or [Diameter]: d
```

```
Diameter of circle: 75
```

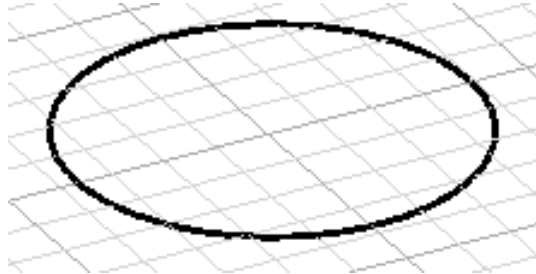

Beginning with a circle

3. Because we extrude objects several times in this tutorial, I show you two different ways to do it. For the first extrusion, we use the official **dmExtrude** command. To extrude the circle into a cylinder that is 16mm tall, start the command like this:

```
: dmExtrude
```

```
Select entities/subentities to extrude or set [M0de]: (Select the circle)
```

```
Entities/subentities in set: 1
```

```
Select entities/subentities to extrude or set [M0de]: (Press Enter to continue)
```

```
Specify height of extrusion or [Auto(subtract or create)/Create/Subtract/Unite/Taper angle/Direction/Limit] <Auto>: 16
```

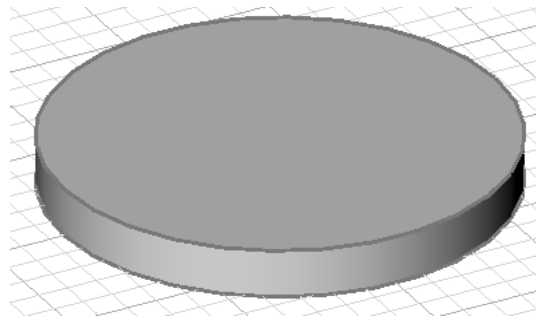

Extruding the circle to 16mm tall

The next bit is to add a stopper to the top of the lid. This is done in two steps: first, we draw a circle on top of the cylinder, and then we pull up the circle, creating the stopper in 3D. This time around, we use the Quad cursor to do the extrusion.

4. First, draw the circle.

- a. Start the **Circle** command, and then enter **CENter** entity snap mode. This ensures that the circle is located at the precise center of the round face. We specify center entity snap with “cen”:

```
: circle
```

```
Select center of circle or [2 Point/3 Point/Tangent-tangent-Radius/turn Arc into circle/Multiple circles]: cen
```

```
Snap to centerpoint of: (Move cursor, as described below)
```

- b. Move the cursor to the top of the cylinder. Notice that it turns blue and that the grid jumps to the cylinder's top. This indicates that *dynamic UCS* is at work. (If BricsCAD doesn't do this, then click the **DUCS** button on the status bar to turn it on.) Dynamic UCS automatically relocates the 2D working plane in 3D space.

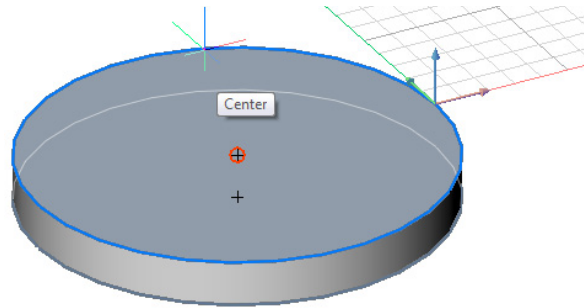

BricsCAD finding the center of the top of the cylinder

- c. Draw a circle 65mm in diameter.
Set Radius or [Diameter] <75>: 65

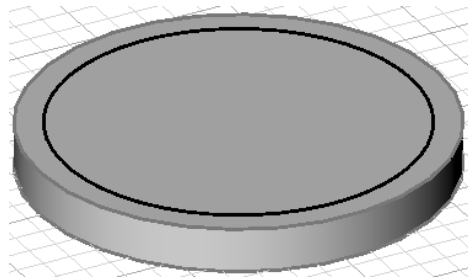

Circle drawn on top of cylinder

5. Move the cursor over the circle we just drew. Notice the Quad.

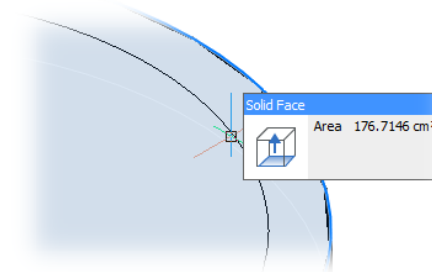

Quad appearing when cursor hovers over an entity

If the Quad does not appear, be sure to click the **QUAD** button on the status bar.

6. Move the cursor into the Quad. Notice that it expands to display a row of commands.

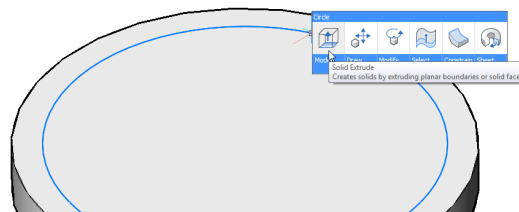

Moving the cursor into the Quad

7. Move the cursor over the icons until we find the command you need: **Solid Extrude**. Click the  icon, and then enter **8** for the height, and then press **Enter**.

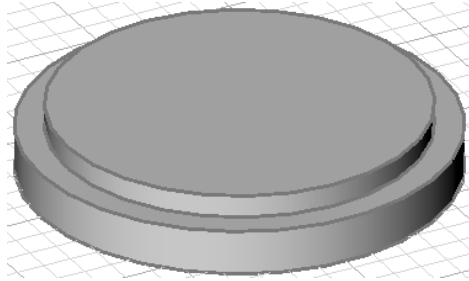

Second cylinder sitting atop the first

8. Round the edges with the **dmFillet** command, as follows:

: dmFillet

Select edges to create fillet: *(Select the edge highlighted by blue in the figure below)*

Entities/subentities in set: 1

Select edges to create fillet: *(Press Enter to continue)*

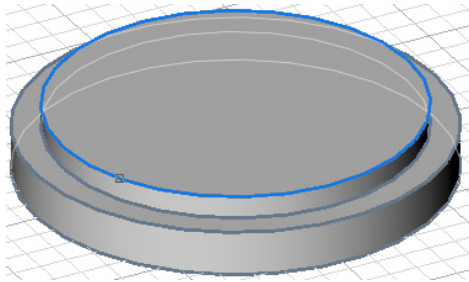

Choosing the edge to fillet

9. Specify a fillet radius of **4**.

Specify fillet radius: **4**

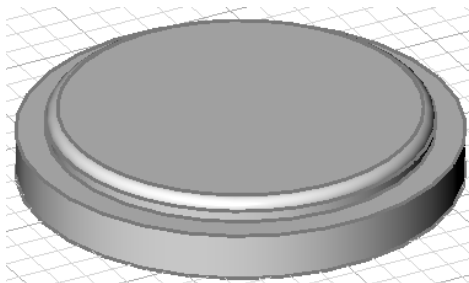

Completed lid with filleted edge

10. To view the lid from a variety of angles dynamically, hold down the **Shift** key and then move the mouse while holding down the center button (or roller wheel) — just as in AutoCAD.

Workspaces, 3D Viewing, Quad Cursor, Manipulate, & 3D Mouse

BricsCAD provides many ways to view models in 3D. I describe some of them in this section.

SWITCHING WORKSPACES

To switch between 2D and 3D drafting environments, BricsCAD uses the same concept of “workspaces” as AutoCAD. The table compares equivalent workspace names between BricsCAD and AutoCAD:

BricsCAD Workspace Name	Equivalent AutoCAD Workspace Name
BIM	...
Drafting	Drafting and Annotation
Drafting (toolbars)	...
...	3D Basics
Mechanical	...
Modeling	3D Modeling
(new in V20) Modeling (toolbars)	...

Accessing the Workspace Commands

- ▶ Enter the **WsCurrent** command
- ▶ Open the **Workspaces** toolbar and then chose a workspace

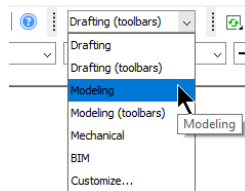

Changing to another workspace in the Workspaces toolbar

- ▶ Right-click the current workspace name on the status bar, and then choose another one

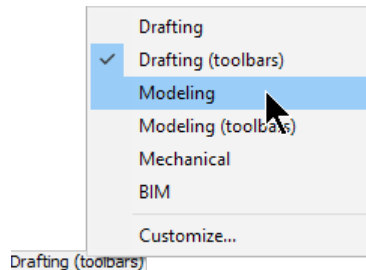

Changing to another workspace from the status bar

VIEW ROTATION & UCS FACE COMMANDS

Modeling in 3D is just like drawing in 2D: for the most part, we still work on a 2D x,y-plane, but in this case the 2D plane is often a face on a 3D object. Because 3D objects typically have six or more faces, it is important to land on the correct face quickly.

BricsCAD enables this through *dynamic* UCS, which, like AutoCAD, places the x,y-plane onto the selected face. To turn on this function, click the **DUCS** button on the status bar.

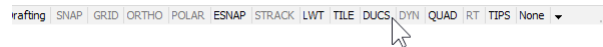

Turning on dynamic UCS in BricsCAD

(NEW IN V20) Dynamic UCS also works with most 2D entities.

In addition to DUCS, BricsCAD has view rotation commands that quickly swivel our view around the 3D model. The two most important ones are:

Real-time zoom — roll the mouse's roller wheel back and forth to zoom out and in

Real-time rotation — hold down mouse's wheel along with the **Ctrl** key, and move the mouse around

Some of these work the same as in AutoCAD, but have different names, as the table below indicates:

BrisCAD	AutoCAD	Description
Navigate	3dWalk, 3dFly	Walks or flies through 3D models
RtRot	3DOrbit	Rotates the 3D view dynamically
RtRotCtr	3DCOrbit	Rotates the 3D view about a user-defined center point
RtRotF	3DFOrbit	Rotates the 3D view freely
RtRotX	...	Rotates the 3D view about the screen's x-axis
RtRotY	...	Rotates the 3D view about the screen's y-axis
RtRotZ	...	Rotates the 3D view about the screen's z-axis

Accessing the 3D Viewing Commands

- ▶ Enter the commands listed in the table above
- ▶ From the **View** menu, choose **Real Time Motion**
- ▶ Open the **View** toolbar, and then click the **Real Time** flyout

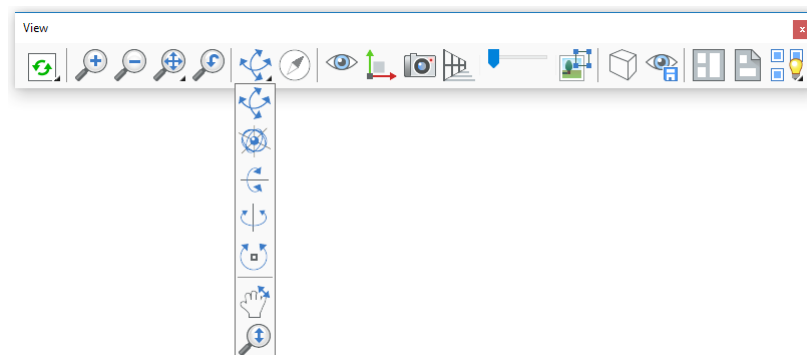

- ▶ In the ribbon's **View** tab, choose commands from the **Navigate** tab

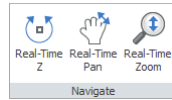

VISUAL STYLES

Three-D modeling means that objects can be rendered to look lifelike — or even artificial. BricsCAD offers visual styles so that you can draw and edit in rendered mode.

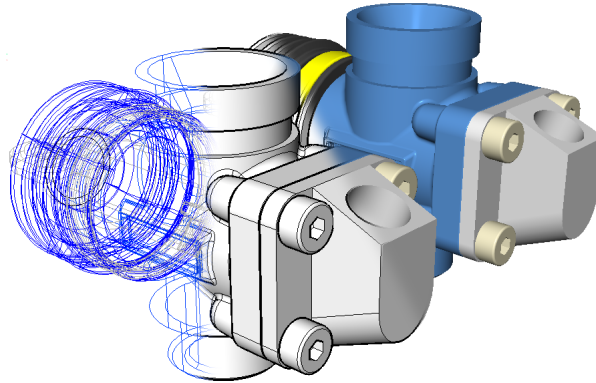

Left to right: Wireframe, shades of gray, and rendered visual styles in BricsCAD

You can customize styles through the Drawing Explorer. AutoCAD has the same system of customizable visual styles, but offers fewer presets styles. See chapter 3 for a comparison table of named visual styles available in both CAD packages.

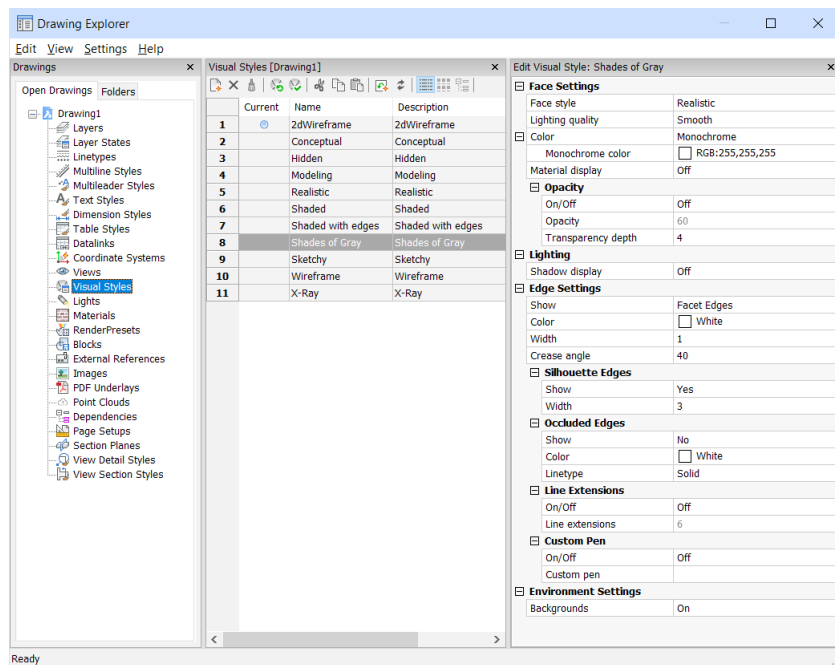

Parameters for visual styles

My preferred way to change visual styles is with the Properties panel. My preferred visual style is “Shades of Gray.”

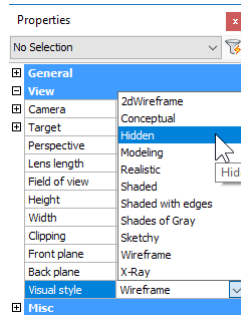

Accessing Visual Styles Commands

- ▶ Enter the **VisualStyles** command
- ▶ From the **View** menu, choose **Visual Styles**
- ▶ From the **Tools** menu, choose **Drawing Explorer**, and then **Visual Styles**

WORKING WITH THE QUAD CURSOR

All editions of BricsCAD provide the Quad cursor. (AutoCAD has nothing similar.) It provides intuitive access to contextual commands. The Quad cursor changes its content, depending on the context. Contexts that affect the Quad cursor include drawing/editing and the workspace:

1. When you first “hover” of an object (entity), the Quad appears and lists some of the properties of the object. *Hover* means that the cursor is over an object, but the object is not picked with a click. You can change the properties displayed by the Quad through the **Customize** command; see chapter 4.

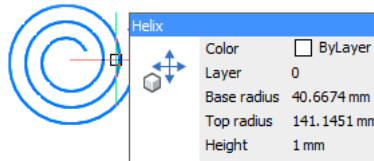

Entity is not selected, so Quad shows some of its properties

TIPS If you do not see the Quad, then click the **QUAD** button on the status bar.

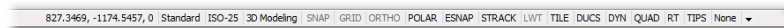

If you do not see entity properties displayed by the Quad, click the **RT** button on the status bar; “RT” is short for rollover tooltips.

2. When no objects are selected, right-click to put the Quad cursor into drawing mode.

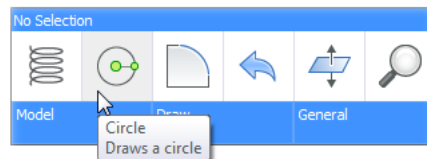

Drawing commands in the Quad when right-clicking an empty spot in the drawing

3. Selecting an object put the cursor into editing mode. The content of the cursor changes, depending on which on the entity and the current workspace.

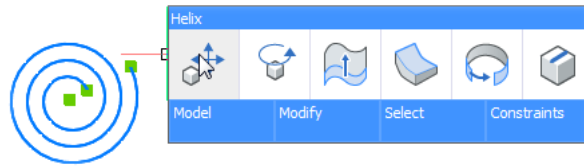

Initial set of editing commands displayed the by Quad

4. To see more commands, move the cursor into one of the blue tabs, such as “Model” or “Modify.”

TIPS When you right-click an empty area of the drawing with QAD turned off, BricsCAD repeats the last command.

The first icon displayed by the Quad is the command that was last used.

Accessing the Quad Command

- ▶ Enter the **QuadDisplay** command
- ▶ Click **QUAD** on the status bar
- ▶ Drawing mode: right-click an empty part of the drawing
- ▶ Editing mode: pause the cursor over an entity, with no command running

BRICSCAD'S MANIPULATOR VS AUTOCAD'S GIZMO

Editing in 3D is tricky business, and so both CAD programs provide dynamic UCSs and a widget to more easily perform a few common editing operations on 3D parts. In AutoCAD, it is called the *gizmo*; in BricsCAD, the *manipulator*.

When the manipulator is turned on (with the **Manipulator** variable set to 1 or 2), it attaches the manipulator widget to the nearest entity. The widget rotates, moves, mirrors, and scales entities along the x, y, or z axes or xy, xz, or zy planes. Entity editing is performed by dragging the arrow-heads or bars, or else by entering values for precise control via dynamic dimensions. The command works on 2D and 3D entities.

The AutoCAD version suffers from two limitations. Whereas AutoCAD needs three gizmos to move, rotate, and scale, BricsCAD combines all these actions (and more!) into one. Whereas the AutocAD version works only in a visual style (and not in 2D wireframe mode), the BricsCAD one always works.

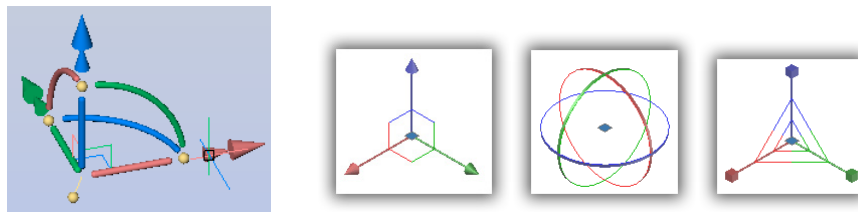

Left: Single Manipulator widget in BricsCAD; **right:** three gizmos in AutoCAD

Here is a comparison of functions performed by the widgets:

Function	BricsCAD	AutoCAD
Scale	Yes*	Yes (with scale gizmo)
Move	Yes	Yes (with move gizmo)
Rotate	Yes	Yes (with rotate gizmo)
Mirror	Yes*	No
Copy	Yes (hold down Ctrl key)	No

* Function is determined with the shortcut menu's **Arrowhead Acts As** option

See chapter 1 (“New Manipulator Widget”) and chapter 2 (“Gizmo vs Manipulator”) for details on using the manipulator in BricsCAD.

HOTKEY ASSISTANT

The Hotkey assistant is a BricsCAD user interface element that appears during certain drawing and editing operations and when selecting entities. It allows you to select command options without using the keyboard. (AutoCAD has nothing like this.) In earlier releases, this assistant was known as the Tips bar.

For example, the bar illustrated below appears with the **dmExtrude** command.



Hotkey assistant for direct extrusion options

The  Ctrl icon reminds you to tap the **Ctrl** key to move through the options listed in the bar. The next four icons are for the Auto, Create (currently highlighted), Subtract, and Unite options. Clicking the **x** dismisses the bar; it does not cancel the command.

The next Hotkey bar, shown below, appears when selecting entities:



Hotkey assistant for selecting 3D entities

The three icons for selecting an entity, a face, or an edge. Remember to press the **Ctrl** key to switch between them.

You toggle the display of the Hotkey assistant with the **HKA** button on the status bar. When you right-click the **HKA** button, you access the Hotkey Assistant Configuration dialog box. It lets you determine which actions display the Hotkey.



Configuring the Hotkey Assistant

WORKING WITH A 3D MOUSE

BricsCAD supports a 3D mouse when it is plugged in and the 3dconnexion driver is installed and running. AutoCAD also supports 3D mice. While AutoCAD provides access to 3D mouse functions inside the program, BricsCAD does not; its sole option is the **Ctrl3DMouse** variable, which toggles use of the 3D mouse.



External to BricsCAD, use the 3Dconnexion Properties dialog box to set the movements of the mouse's puck and actions of the its buttons.

To access this dialog box in Windows 7, click the **Start** button, and then choose **All Programs | 3Dconnexion | 3D Mouse Control Panel**, and then click **Properties**.

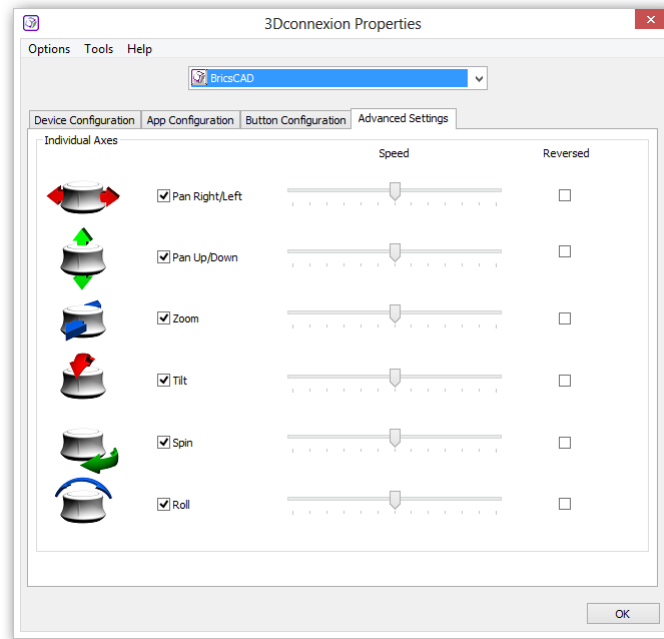

3Dconnexion control panel determines how BricsCAD reacts to the 3D mouse

In Windows 8.x and 10, click the start button and then start typing “3dcon...” until the program appears in the search results.

3D Geometric & 3D Dimensional Constraints

Working with 3D constraints in BricsCAD is just like working with 2D constraints in AutoCAD. The difference is that they also operate in the z-direction. (AutoCAD has no 3D constraints.) You can use expressions and parameters to specify values and formulae for 3D dimensional constraints, just as AutoCAD does for 2D constraints.

The 3D constraints are available in the Pro and Platinum editions of BricsCAD. The difference is that while the Pro version can solve constraints, only the Platinum edition can apply them.

BricsCAD also applies parameters to arrays. (AutoCAD cannot do this.) To do so, use the Properties panel: edit array properties, such as Rows and Rows Spacing, to replace them with formulas. As a side note, arrays in BricsCAD are associative and 3D.

3D Dimensional Constraints	Meaning
dmAngle3D	3D angle constraint
dmDistance3D	3D distance constraint
dmRadius3D	3D radial constraint

3D Geometric Constraints	Meaning
dmConstraint3d	Super command that applies any kind of 3D constraint
dmCoincident3D	3D coincident constraint
dmConcentric3D	3D concentric constraint
dmFix3d	3D fix constraint
dmParallel3D	3D parallel constraint
dmPerpendicular3D	3D perpendicular constraint
dmTangent3D	3D tangency constraint

WORKING WITH 3D CONSTRAINTS

For a tutorial on using 3D constraints, see the Assembly Drawings section later in this chapter.

Accessing 3D Constraint Commands

- ▶ Enter the commands listed in the table above
- ▶ From the **Parametric** menu, choose **3D Constraints**
- ▶ Open the **3D Constraints** toolbar



- ▶ In the ribbon's **Parametric** tab, select commands from the **3D Constraints** panel

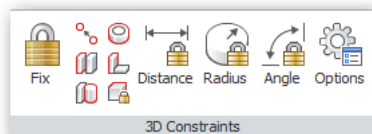

3D Design Intent

BricsCAD Platinum can determine what you were probably intending to design, automatically. This is known as *design intent*. When design intent is turned on, BricsCAD recognizes parts of 3D entities that ought to be edited together. This is similar to the actions of another MCAD program known as Solid Edge, where the function is named “Live Rules.” (AutoCAD does not provide design intent.)

Consider an object that has several holes, all of the same size. When design intent is running, it recognizes that they have the same diameter, and so when you change the diameter of one hole, BricsCAD changes the diameters of the others, as well — automatically. This is why design intent is also known as “automatic 3D geometry constraints recognition.”

Unlike constraints, design intent cannot, unfortunately, be applied to specific areas of a model: design intent is universal. You can choose, however, which types of design intent to apply. For instance, you can ask BricsCAD to recognize planes that are parallel or coincident or both.

BricsCAD recognizes the following relationships:

- ▶ Tangencies
- ▶ Coincidences
- ▶ Parallelism
- ▶ Perpendicularity
- ▶ Coaxiality
- ▶ Equality
- ▶ Radius

I find it most convenient to toggle settings through the Design Intent toolbar. (Click the big red X to switch off design intent.)

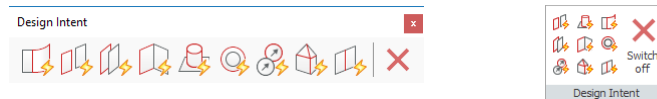

Left: Design Intent toolbar; **right:** Design Intent settings on the ribbon

There is another limitation common to all CAD systems that employ automatic feature recognition. The engine works only with 3D solids that it recognizes. For BricsCAD, this means the shapes listed in the table below. Note that simple shapes can be part of a more complex body.

With each release, Bricsys adds more recognition functions. For instance, the BIM and Mechanical editions have their own sets of design intent systems that recognize entities specific to the two disciplines.

Design intent settings are toggled through the **dmRecognize** variable; see table below. Setting the value negative turns off design intent, but retains the former value.

dmRecognize	Description	Used With These Entities
0	All off	
1	Tangent surfaces	Planes, cylinders, cones
2	Coincident planes	Planes
4	Parallel planes	Planes
8	Perpendicular planes	Planes
16	Cylinders perpendicular to planes	Cylinders, planes
32	Coaxial surfaces of cylinders and cones	Cylinders, cones
64	Equal radius on cylinders (or holes) and spheres	Cylinders, spheres
128	Vertices between four or more faces	Faces
256	Edges between coincident faces	Edges, faces
negative value	All off, yet retains value of the previous setting	

WORKING WITH DESIGN INTENT

Because design intent is not available in AutoCAD, I'll give you a tutorial on how it works. In BricsCAD, you draw a 3D shape and then use the **dmPushPull** command without — and with — design intent turned on.

1. Start BricsCAD in the Modeling workspace.
2. Draw a 2D shape with the **PLine** command, similar to the one shown below. For this tutorial, the exact size does not matter.

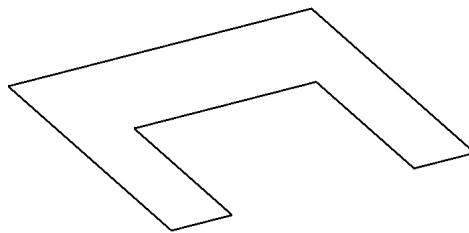

Closed polyline drawn with the PLine command

3. Turn the 2D shape into a 3D model by executing the **Extrude** command from the Quad cursor. To do so, follow these steps:
 - a. Move the cursor over the polyline. Notice that the polyline turns blue to indicate it has been selected.
 - b. Move the arrow cursor into the Quad cursor; notice that it expands.

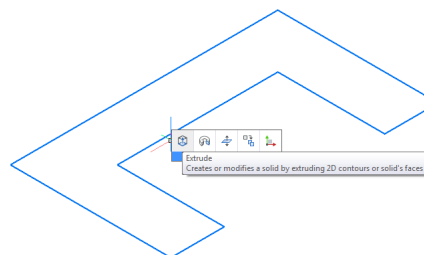

Exposing the Quad cursor over the polyline

- c. Click the  **dmExtrude** button. It is not necessary to select the polyline, as the Quad recognizes it automatically. This is a benefit to using the Quad cursor to execute commands!
Specify height of extrusion or [Direction/Path/Taper angle] <1>: **10**

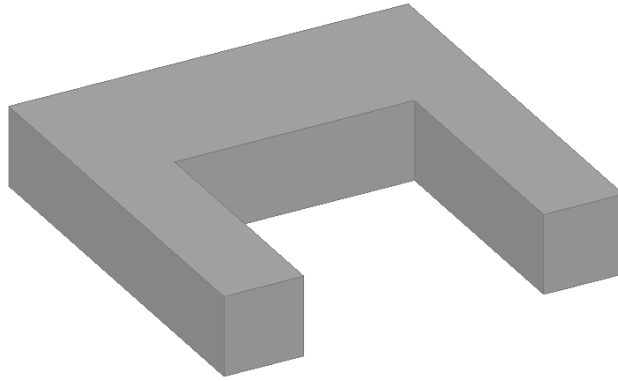

Polyline extruded into a 3D model with the Extrude command

4. Open the Design Intent toolbar:
 - a. Right-click any toolbar or ribbon, and then choose **BRICS CAD | Design Intent**.
 - b. Ensure design intent is turned off by clicking the  red X button at the end of the toolbar.

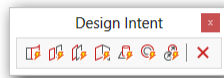

Click the last button on the right to turn off all design intent modes

5. Now you change the length of one arm, with design intent turned off. From the Quad cursor, access the  **dmPushPull** command.

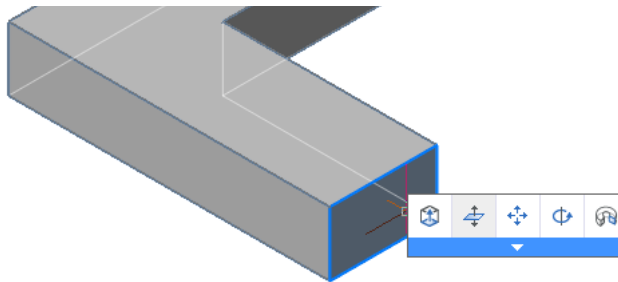

Choosing the dmPushPull command from the Quad cursor

6. Drag the face indicated by the figure below. Notice that the coincident face remains in place.

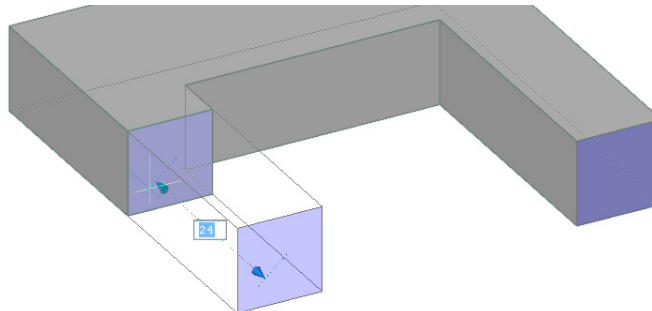

Dragging one face with the dmPushPull command

7. In the Design Intent toolbar, turn on  **Coincident Planes**.
8. Repeat the **dmPushPull** command to see the effect of design intent on your editing operations. As you drag one face, notice that the coincident face moves along.

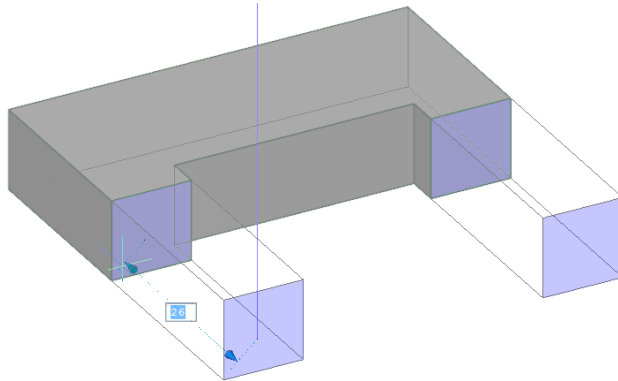

Both planes move together when Coincident Planes is turned on

BricsCAD recognized that the other edge was in the same plane as the first one, and so moved it simultaneously and automatically. Should you wish this to not occur, simply turn off design intent.

Accessing Design Intent Commands

- ▶ Enter the **dmRecognize** variable
- ▶ Enter the **Settings** command and then go to the **Drawing | Drafting | Direct Modeling** section
- ▶ Open the **Design Intent** toolbar

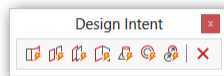

- ▶ In the ribbon's **Parametric** tab, look for commands in the **Design Intent** panel.

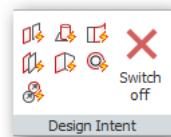

Mechanical Browser

BricsCAD offers the Mechanical Browser for tracking parts. In AutoCAD, the equivalent is the Parametric Manager palette.

The **MechanicalBrowserOpen** command opens the Mechanical Browser panel. It keeps track of parts in assemblies (not available in AutoCAD), lists the constraints that are attached to parts, and records formulae for dimensional constraints (AutoCAD supports constraints). Formulas (expressions) can also be assigned to nested entities using the Mechanical Browser.

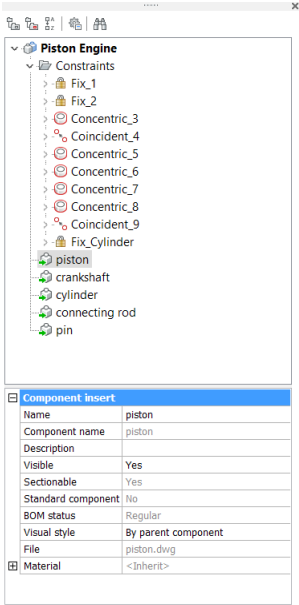

Mechanical Browser panel

Right-click a node to access a shortcut menu that contains most of the commands available in the browser.

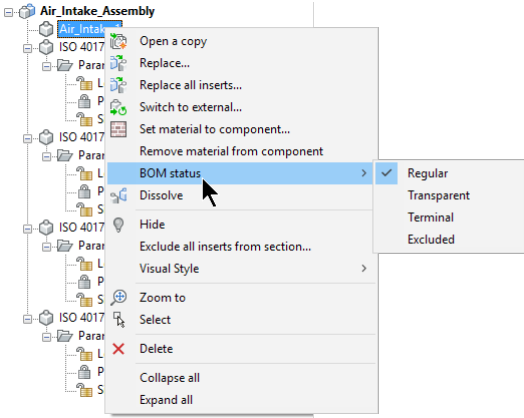

Options in the context menu

The Mechanical Browser is useful for working with 3D models, assemblies, BIM designs, and sheet metal projects. The left end of its toolbar displays the model tree in different ways:



Mechanical Browser's toolbar

Group by entity lists each entity in alphabetical order together with a set of constraints, if any

Group by type lists all constraints first, and then all entities in alphabetical order

Alphabetic sort the list in obverse and reverse alphabetical order

The other buttons on the toolbar handle these functions:

(NEW IN V20) **Settings** controls the types of items listed by the panel

(NEW IN V20) **Search toggle** turns the search bar on and off

(NEW IN V20) **Search** allows you to find specific entities in large drawings; click the up and down arrows when your search term matches more than one entity

Accessing the Mechanical Browser

- › Enter the **MechanicalBrowserOpen** command
- › Right-click any toolbar or ribbon tab, and then choose **Mechanical Browser** from the shortcut menu

TOOL PALETTES

The Tool Palettes panel also accesses commonly-used parts for 3D modeling. The Form Features tab, for instance, contains 3D parametric parts useful for sheet metal design. To place the parts, drag them from the panel into the drawing.

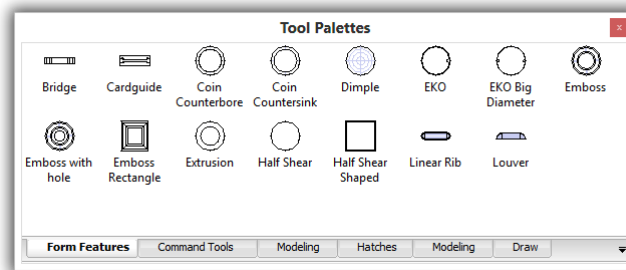

Tools Palette with form features

Accessing the Tools Palette

- › Enter the **ToolPalettes** command
- › Right-click any toolbar or ribbon tab, and then choose **Tool Palettes** from the shortcut menu

Modeling and Deforming 3D Surfaces

BricsCAD performs surface modeling with direct modeling commands and 3D constraints. While these commands were meant originally to work with 3D solids, they now also produce or edit surfaces — depending on the context. AutoCAD also does surface modeling, although it lacks 3D constraints supplied in BricsCAD.

The surfaces made by BricsCAD are true surfaces, meaning that can be deformed. Creating and editing surfaces in BricsCAD works just like in AutoCAD. The vertices, edges, and faces of surfaces are deformed with the same commands used to deform 3D solids. Use the following commands to create and edit surfaces:

BricsCAD Surface Commands	Meaning
Modeling Commands	
dmDeformCurve	Deforms by moving or rotating edges to a specified set of target curves
dmDeformMove	Moves or rotates edges of surfaces
dmDeformPoint	Transforms points lying on specified faces
dmDelete	Removes holes (open loops) and faces from surfaces
Editing Commands	
dmExtrude	Extrudes curves, edges, planar entities, and faces into 3D surfaces
dmRevolve	Revolves curves, edges, planar entities, and faces into 3D surfaces
dmStitch	Stitches a set of surfaces into a single 3D surface
dmThicken	Converts surfaces to 3D solids with a specified thickness
dmTwist	Twists 3D surfaces
<p>When extruding or rotating a 2D entity, BricsCAD converts them automatically depending on their type: <i>Open 2D entities become 3D surfaces</i> <i>Closed 2D entities become 3D solids</i> To turn a 3D surface into a 3D solid, use the dmThicken command.</p>	

Accessing Surfacing Commands

- ▶ Enter then commands listed above
- ▶ No access to the commands through the menu bar or toolbars
- ▶ From the ribbon's **Surfaces** tab, choose a command

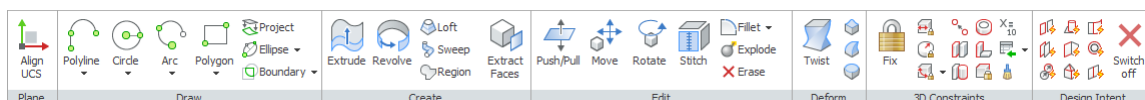

3D Sections

BricsCAD Pro and Platinum editions can make 2D and 3D sections of 3D models, and use the same commands as does AutoCAD:

Section Commands

Section creates section planes from 3D solids made of region entities

SectionPlane creates section entities from 3D solids, surfaces, and meshes

LiveSection toggles the Live Section property of a section plane

SectionPlaneSettings defines properties of section plane entity in the Drawing Explorer

SectionPlaneToBlock saves the selected section plane as a block

WORKING WITH SECTIONS

Sections in BricsCAD work exactly the same as sections in AutoCAD.

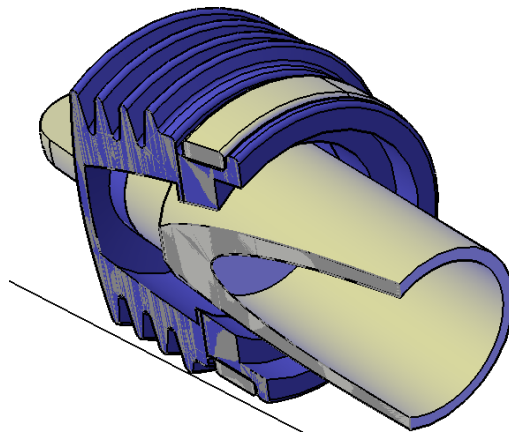

Live sectioning a 3D model in BricsCAD

Accessing the Commands

To access the sections feature:

- ▶ Enter the commands listed in the table above
- ▶ Open the **Sections** toolbar

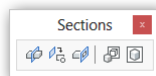

- ▶ In the ribbon's **Modeling** tab, look for the commands in the **Sections** tab

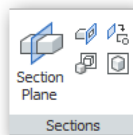

- ▶ From the **Model** menu, choose **Sections**

Drawing Views vs Model Documentation

BricsCAD Pro and Platinum editions generate 2D drawings and sections from 3D models. These are called “drawing views” (or “generative drawings” in earlier releases). Because the drawings are associative, they update automatically when you make changes to the 3D model. AutoCAD has the same function, but calls it “model documentation.”

Generative Drawing Commands

ViewBase generates 2D views of 3D models in paper space

ViewDetail generates detail views from 2D views made by ViewBase

ViewDetailStyle specifies the style of detail views and detail symbols

ViewEdit changes the scale and the hidden line visibility of drawing views; can be used in paper space only

ViewExport exports generated drawings from paper space to model space; destroys 3D information

ViewProj generates additional projected views from existing drawing views

ViewSection generates sections from 2D views made by ViewBase

ViewSectionStyle specifies the style of section views

The method of placing 2D views of 3D models in BricsCAD is similar to that of AutoCAD: begin with the **ViewBase** command. BricsCAD switches to a layout automatically, and then you can start placing views.

The first view placed is the front view; other views are created automatically and depend on how you move the cursor. The result is a drawing that usually looks like this:

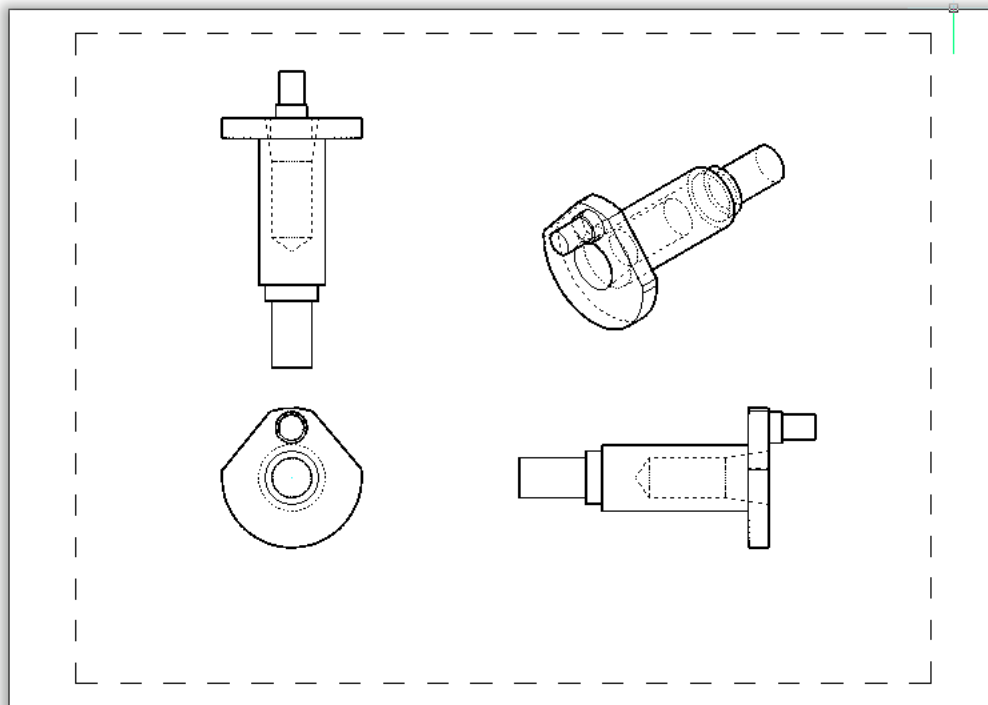

From top, clockwise: the top, isometric, side, and front views

Creating sections and details in BricsCAD are also just like in AutoCAD, with the **ViewSection** and **ViewDetail** commands.

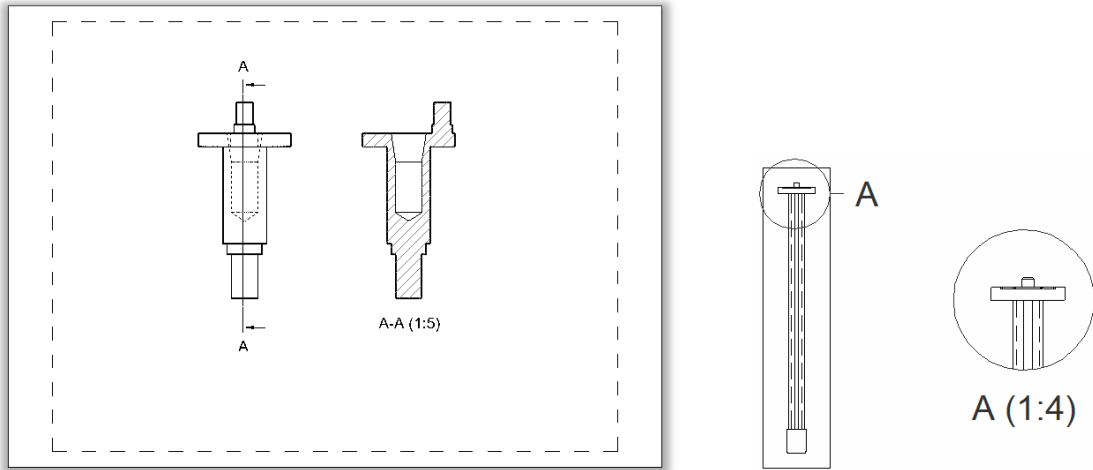

Left: Section view created by BricsCAD; right: Detail view

You can customize the way that sections and details appear with BricsCAD's **ViewDetailStyle** and **ViewSectionStyle** commands. These operate similarly to the way they do in AutoCAD.

Accessing Generative Drawing Commands

- ▶ Enter the one of the commands listed above
- ▶ From the **View** menu, open the **Drawing Views** submenu
- ▶ Open the **Drawing Views** toolbar

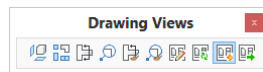

- ▶ In the ribbon's Annotate tab, select commands from the **Drawing Views** panel

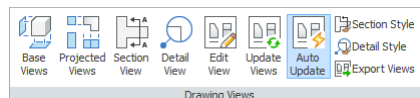

Bills of Material vs Data Extraction

BricsCAD Platinum edition generates bills of materials from 3D models with the **bmBomPanelOpen** command, which opens a panel so that you can edit the look of the BOM table. AutoCAD does something similar through the **DataExtraction** command, after which you place the data as a table in the drawing.

The difference is that the command in BricsCAD is easy to use (enter no options, if you wish), while the command in AutoCAD is complex, as it requires many steps. (BricsCAD also has a **bmBom** command that works at the command line.)

As well, BricsCAD places balloons whose numbers are referred to by the BOM table, and edits the BOM dynamically through the Bills of Material palette.

HOW BOMs AND BALLOONs WORK IN BRICSCAD

(NEW IN V20) The BricsCAD bill of materials function works only with drawings created as assemblies and components. To see how BOMs and balloons work in BricsCAD, open an assembly drawing and then enter the **bmBomPanelOpen** command:

: **bmBomPanelOpen**

Notice the Bills of Materials panel, and that it is immediately populated with a BOM table that BricsCAD generated automatically.

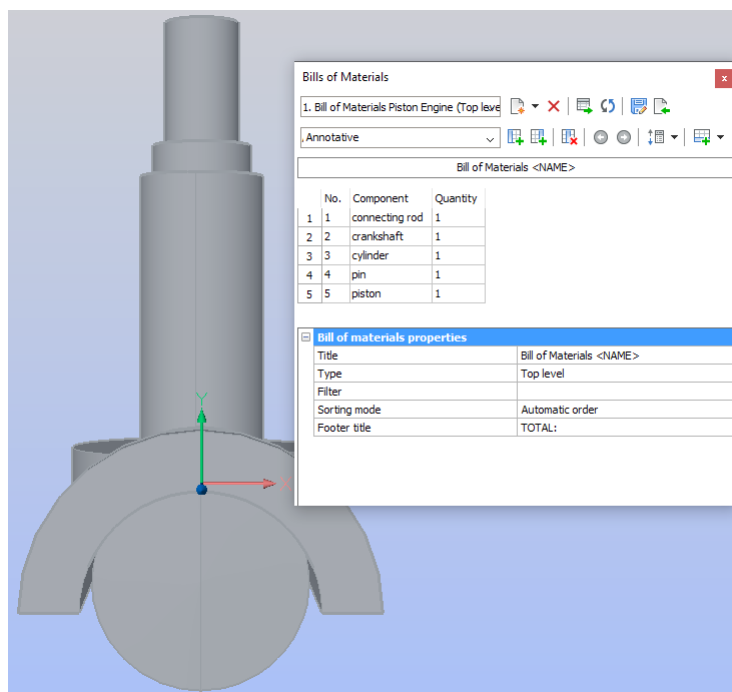

Bill of materials generated by BricsCAD automatically

Click the **Insert Table** button to place it in the drawing:

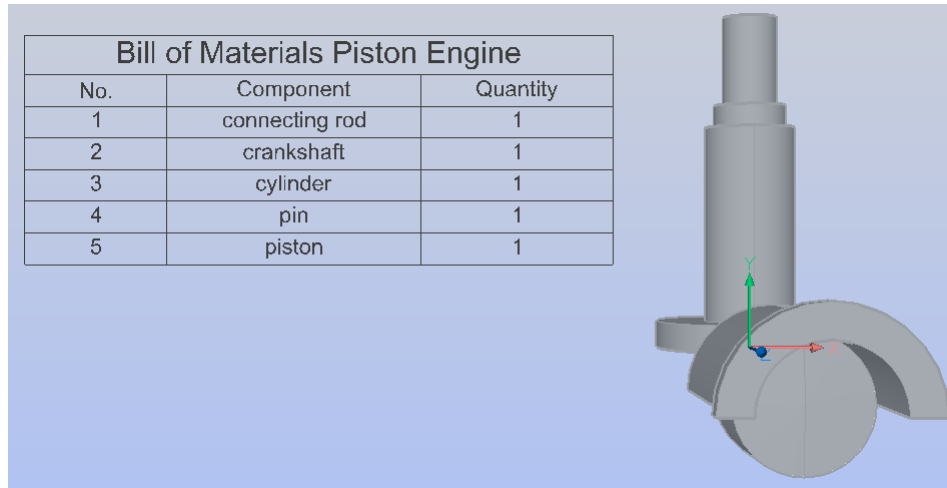

BOM placed in drawing

That's it! Two steps to place a BOM. BricsCAD knows about the components in the drawing, and numbers and counts them automatically. Notice that the table lists the mechanical components as follows:

- No.** is the components's sequence number that always begins with 1
- Part** identifies the name of the component, as extracted from the Mechanical Browser
- Quantity** reports the number of occurrences of the component

EDITING BOMS

To change the content of the BOM table, follow these steps:

1. From the droplist, choose a parameter, such as "Volume".

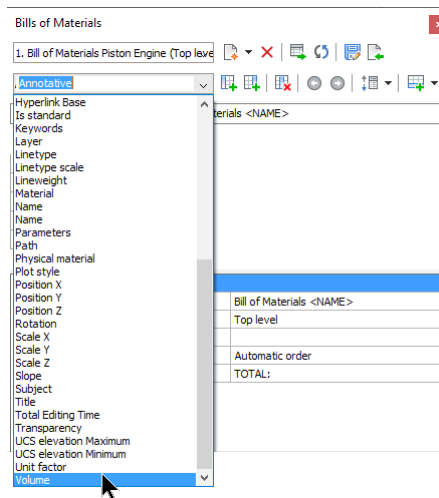

2. Choose a column of the table, such as the last one (Quantity). Notice that it turns gray.

- To add the column to the table, click **Insert After**. Notice that BricsCAD updates the table in the drawing and in the panel, calculating the volume of each part.

No.	Component	Quantity	Volume, ft ³
1	connecting rod	1	174.2222
2	crankshaft	1	1501.4366
3	cylinder	1	838.5996
4	pin	1	63.7305
5	piston	1	481.4153

Add a column to the BOM table

- To remove a column, select it in the panel, and then click **Remove Column**.

TIP BOMs are normal table entities, and so their content and the tables' cells can be edited like a table, such as by using trips. To export the data in the table to a data file, use the **TableExport** command.

Exploding Assemblies

To better see the parts in an assembly, they often are exploded. This is a technical term that means the parts are moved away from one another. In BricsCAD, this is done with the **bmExplode** command. (AutoCAD does not offer this.)

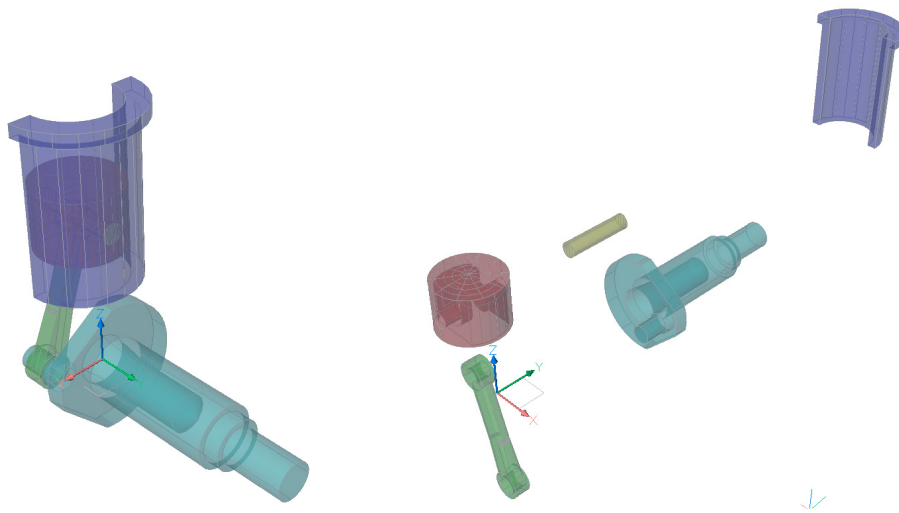

Left: Before... ; right: ...and after exploding the assembly

1. Start the **bmExplode** command, and then use Automatic mode:
 - : **bmexplode**
 - Select explosion algorithm [Table by types/Linear/Automatic/Manual/Settings] <Manual>: **A**
2. Explode the parts according to the current viewpoint, so enter **C**:
 - Enter the minimal gap [enable Leader follower/use Current projection for gap/Auto] <Auto>: **C**
3. Press **Enter** to finish the job:
 - Select exploded view behaviour [Edit/Generate drawing views/Finish] <Finish>: (*Press Enter*)

To animate the explosion, right-click the explosion node in the Mechanical Browser panel, and then choose **Animate**. The animation movement replays itself.

Adding Balloons

Labeling the exploded parts with balloons is nearly as easy as making the BOM.

- : **bmBalloon**
- Select a component insert [select other Table/choose balloon Frame]: (*Pick the pin in the drawing*)
- Pick point to place balloon: (*Place the balloon*)
- Select a component insert [select other Table/choose balloon Frame]: (*Pick the head in the drawing*)
- Pick point to place balloon: (*Place the balloon*)
- Select a component insert [select other Table/choose balloon Frame]: (*Press Enter to exit*)

Notice that the balloons are numbered automatically, and match the numbering in the BOM table. You can use the **bmBalloon** command's options to change the balloon style:

- Select a component insert [select other Table/choose balloon Frame]:

Option	Abbreviation	Prompt	Meaning
select other Table	t	Select a BOM table	Choose a different BOM table
choose balloon Frame	f	Circular Rectangular Triangular Hexagonal CurrenT	Circle balloon frame Rectangle balloon frame Triangle balloon frame Hexagon balloon frame Use same balloon frame

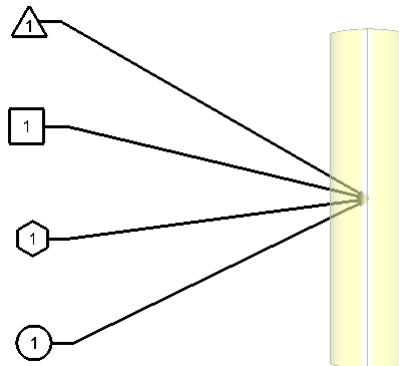

Balloon shapes available in BricsCAD

3D Compare

The **3dCompare** command loads two drawing files, and then finds differences among 3D solids and surfaces using color coding. (AutoCAD does not provide this capability.) The ribbon has toggles that change what you see.

1. Enter the **3dCompare** command, and then choose two drawings files whose content you want to compare. Keep in mind that this commands compares differences only in 3D solids and 3D surfaces; it ignores all other entities, such as dimensions, text, and 2D entities.

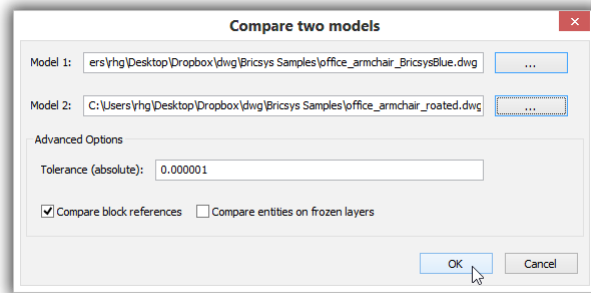

2. Click the **Model 1** button to select the first drawing file.
3. Click the **Model 2** button to select the comparison drawing.
4. Click **OK**. Notice that BricsCAD opens both models in a new viewport named “Comparison.” In the figure below, the base of the chair is colored, because it is different in the second drawing. (The base is rotated by 15 degrees from the original.)

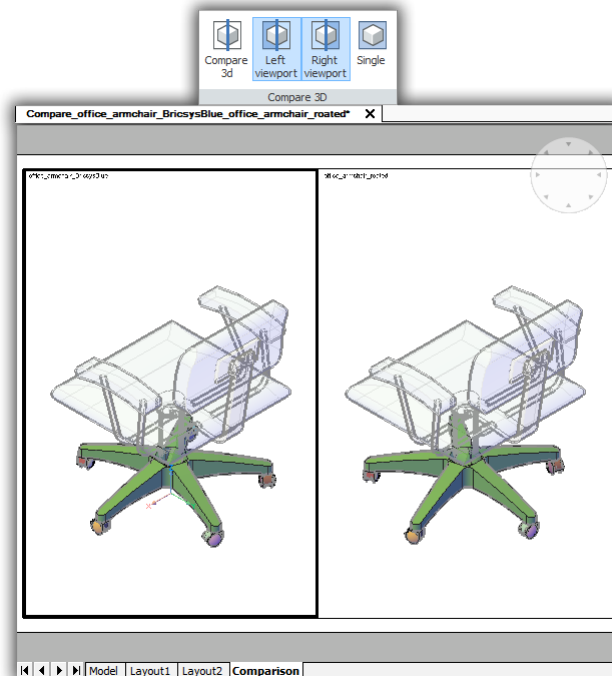

Comparing two slightly different models

5. In the **Tools** tab, buttons in the **Compare 3D** panel let you toggle view settings.

Accessing the Drawing Compare Command

- ▶ Enter the **3DCompare** command
- ▶ From the **Tools** menu, choose **3D Compare**
- ▶ Open the **3D Compare** toolbar.
- ▶ In the ribbon's **Tools** tab, look in the **Compare 3D** panel

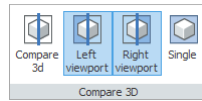

This chapter introduced you to some of the 3D capabilities in the Platinum version of BricsCAD, all of which are not available in AutoCAD. The following chapters introduce you to specific disciplines that use 3D with BricsCAD: BIM, MCAD, and sheet metal design.

BricsCAD for BIM

BRICSYS OFFERS ADD-ON MODULES FOR BRICSCAD THAT PERFORM FUNCTIONS specific to architectural design, mechanical assemblies, sheet metal fabrication, and translation to and from other 3D MCAD (mechanical CAD) systems.

In this chapter, we look at the following add-on:

- ▶ **BIM** (building information modeling) for architects *
https://www.bricsys.com/en_INTL/bim/

*) Function is not available in AutoCAD

The module is available as a free 30-day trial from the Web page listed above. Equivalent software from Autodesk costs thousands of dollars more than BricsCAD BIM. This chapter shows you how to work with architectural design with BricsCAD:

- ▶ Create a BIM model from scratch
- ▶ Define compositions of walls
- ▶ Add components, such as doors
- ▶ (NEW IN V20) Insert stairs
- ▶ Export and view models as IFC files

TIP The tutorials in this chapter require the BIM or Ultimate editions of BricsCAD .

3D BIM Design

The BIM edition of BricsCAD is for modeling buildings in 3D using IFCs (industry foundation classes) and building information modeling (BIM). BricsCAD imports and edits BIM models from other CAD systems using the IFC format. As well, any 3D solid can be used for BIM in BricsCAD, whether created in BricsCAD or imported from other software, by applying the Bimify command.

Commands specific to BIM start in BricsCAD with *bim-*. See Appendix A for the list of these commands.

TUTORIAL: STARTING A BIM DESIGN

New buildings designed with BIM commonly begin the terrain on which the building will be situated. One or more buildings can be designed, each with one or more floors. BricsCAD handles all kinds of buildings.

For this tutorial, however, we will do something simpler by beginning with a 2D floor plan, and then extruding it with the **PolySolid** command into walls and floors.

1. Start BricsCAD with the **BIM** workspace.

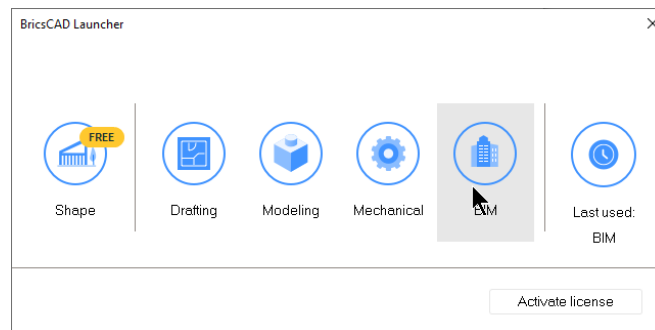

Selecting the BIM profile with inches for units

2. To make it easier to see your work, change the visual style to **Wireframe**. The easiest way to do this in the Properties pane's **View > VisualStyles** option.

TIP The **bimQuickDraw** command quickly draws the shells of buildings from rectangles and L-shapes with height.

Step 1. Drawing the Walls

The **bimQuickDraw** command in BricsCAD creates walls and slabs interactively. As you move the cursor, it draws multi-floor rectangular and L-shaped rooms from scratch. (NEW IN V20) bimQuickDraw draws slabs that represent floors and ceilings. You specify the default height of the rooms, and the thicknesses of walls and slabs.

When you need to convert existing 2D plans into 3D walls, then consider the **PolySolid** command; see boxed text.

In this tutorial, we draw an two-story L-shaped building:

1. Start the bimQuickDraw command:

`: bimquickdraw`

Current settings: Floor to Floor distance: 10'-10", Wall Width: 10", Slab Thickness: 10", Auto Adopt Sizes: On

2. Enter **S** to specify the default values for this command.

Select first point or [quickdraw Settings]: **s**

Notice that the Options dialog box opens at the Quick Draw section.

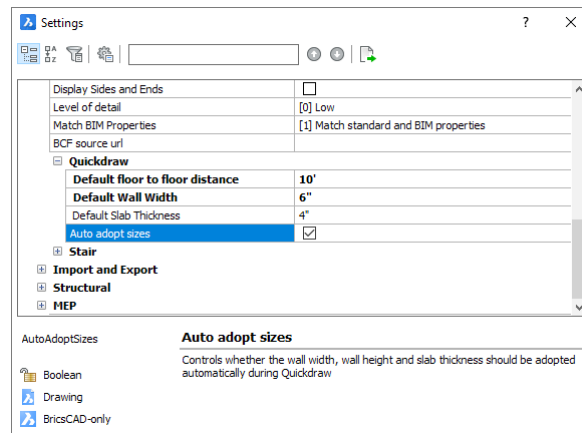

Settings for the QuickDraw command

Change the default values to ones more attuned to building construction:

QuickDraw	Setting
Default floor to floor distance	10'
Default Wall Width	6"
Default Slab Thickness	4"

...and then click the red X to close the dialog box.

3. In the drawing area, notice the blue square. It represents the floor area, while the white outlined area defines the walls.

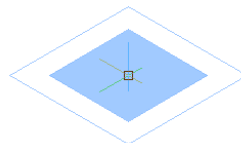

Starting the bimQuickDraw command

POLYSOLID TURNS 2D LINES INTO 3D WALLS

The **PolySolid** command is useful for turning existing 2D floor plans into 3D walls.

1. Start the command and then change the default settings for the wall height and width:

```
: polysolid
Current settings: Height = 80, Width = 5, Justification = Center, Separate solids =
On, Dynamic = On
Start point or [Height/Width/Justification/Entity/Separate solids/Dynamic] <Entity>:
h
Height of polysolid <5>: 8'
```

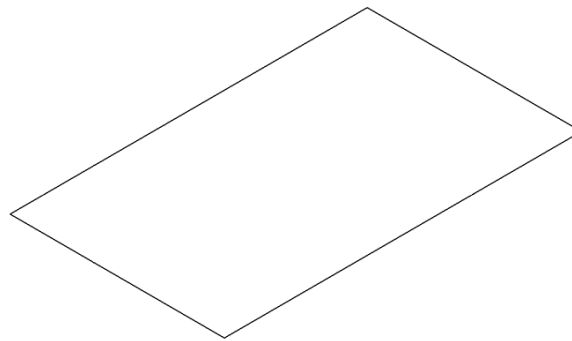

2D rectangle defining the floor area

2. Use the **Entity** option to select the 2D entities to turn into 3D walls:

```
Start point or [Height/Width/Justification/Entity/Separate solids/Dynamic] <Entity>:
e
Select polysolid base: (Pick 2D entities)
```

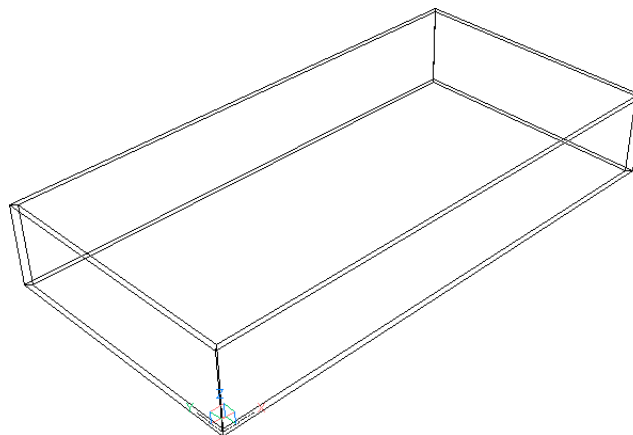

PolySolid command raising the walls

With the walls placed, follow Step 2 and following to classify the wall, add components, and stairs, and export the model in IFC format.

As you move the cursor, the square moves. Click to position it, such as at 0,0. This becomes one corner of the building.

4. Move the cursor some more. Notice that the square elongates into a rectangle with dynamic dimension input:

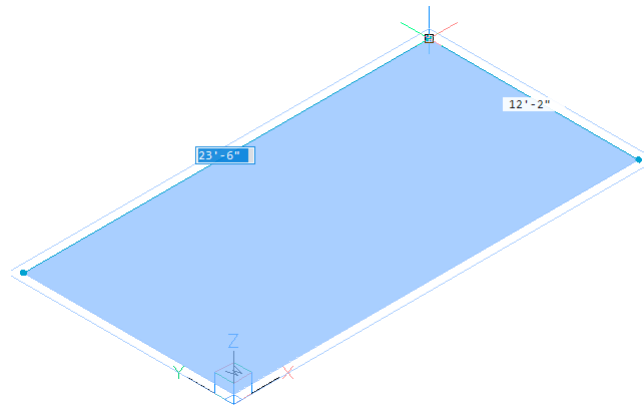

Moving the cursor to size of the room

- ▶ You can eyeball the size of the floor
- ▶ Or you can enter a precise width at the keyboard, then press the **Tab** key to enter the precise length

For this tutorial, enter **25'** and **50'** as the width and length of the building.

TIP During the **bimQuickDraw** command, hold down the **Alt** key to move around the model.

4. When you indicate the opposite corner (and so the size of the floor), the walls and floor (slab) appear.

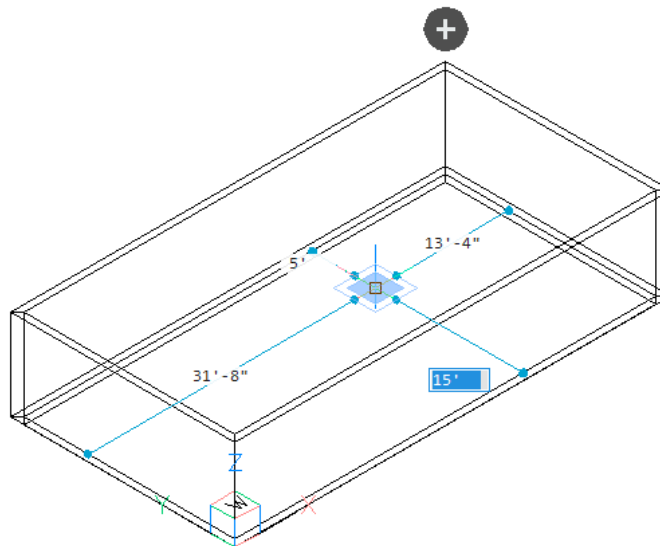

Defining a room with two points

The drawing predominantly features a black + symbol, which adds floors to buildings. The blue square returns, indicating that you can draw another room in any of these configurations:

- ▶ A new room inside or outside the current one, attached to one or two walls
- ▶ An independent room inside the current one

The dynamic dimensions help you locate the new room precisely; as well, BricsCAD has stickiness (kind of like entity snap) at significant locations, such as at the corners and edges of rooms, to make it easier to start new rooms there.

5. Draw an additional room attached to the main ones by starting next to an existing wall. Here you have two choices:

- ▶ Cut out a portion of an existing wall (shown in red, below), and then add the three new walls

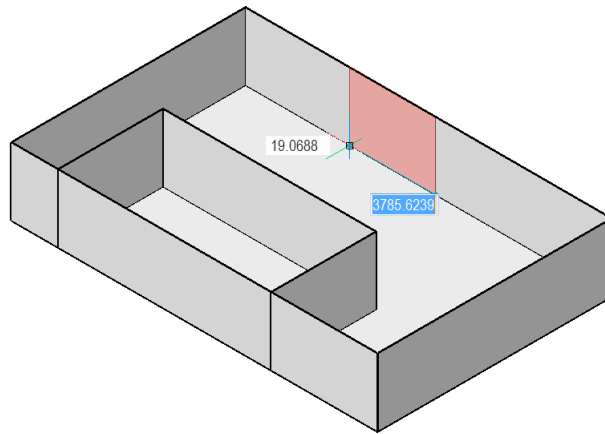

- ▶ Or, leave the existing wall intact, add three new walls, and then insert a door to access the room

a. Move the cursor (blue square) to the edge of a wall; notice that it flip flops to either side of the wall. This lets you start the new room on the inside or outside of the existing room.

To start the new room at a corner, move the cursor to the corner (see figure below); again, notice that the blue square flips to three possible locations: one inside corner and two outside corner locations.

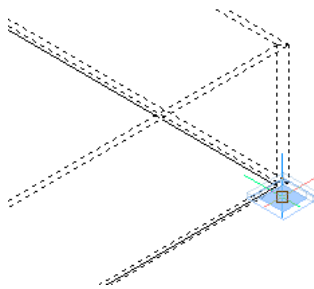

QuickDraw cursor sticking to an outside corner location

You can tell that the cursor is at one of the sticky locations, because the dynamic dimensions disappear.

- b. Click to locate the corner of the new room.
- c. Drag the rectangle (representing the floor of the new room) to size.

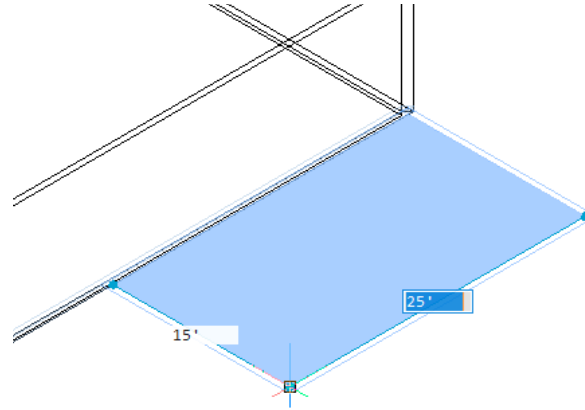

Sizing the new room

- d. Click to place opposite corner of the room.

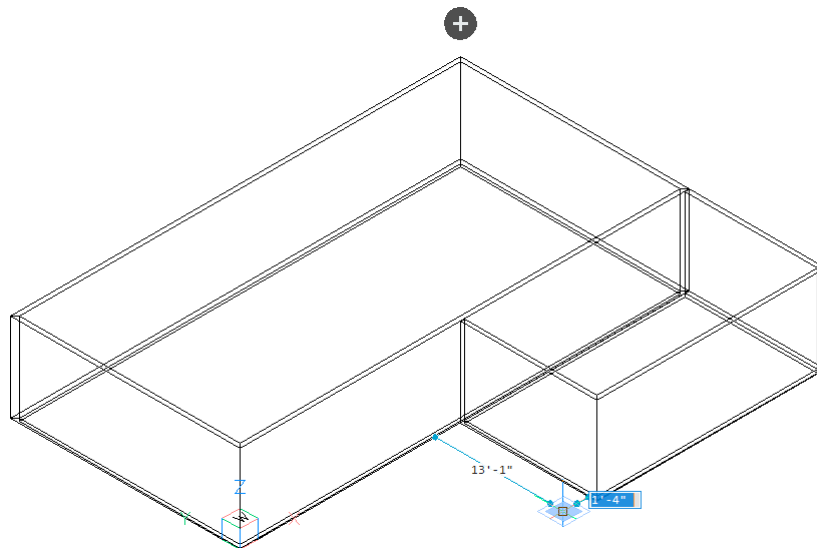



Notice that the blue square cursor is ready to draw another room. But we instead will go on to adding a second story (floor) to the building.

TIP To undo a room addition, exit the **bmQuickDraw** command and then use the **U** command. When you restart the **bimQuickDraw** command, you can continue adding rooms as if you never left off.

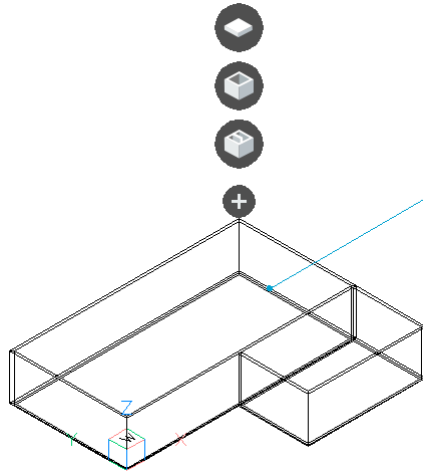
6. To add a story to the building, click the black **+** **Add** button. Each time you click it, another story is added. (NEW IN V20) BricsCAD copies certain elements of the lower floor up by one level:



-  **Slab** — copy only the slab; this option create a flat roof, in effect
-  **Outer** — copy outer walls only, along with the slab; this option is best when the next floor has a different room layout
-  **Full** — copy all elements from the lower floor to the new one; this option is useful when more than one floor has an identical layout

- a. Click the **Outer** or **Full** button to add a second story.
- b. Click the **Slab** button to finish the building shell with a roof.
- c. Press Enter to end the command.

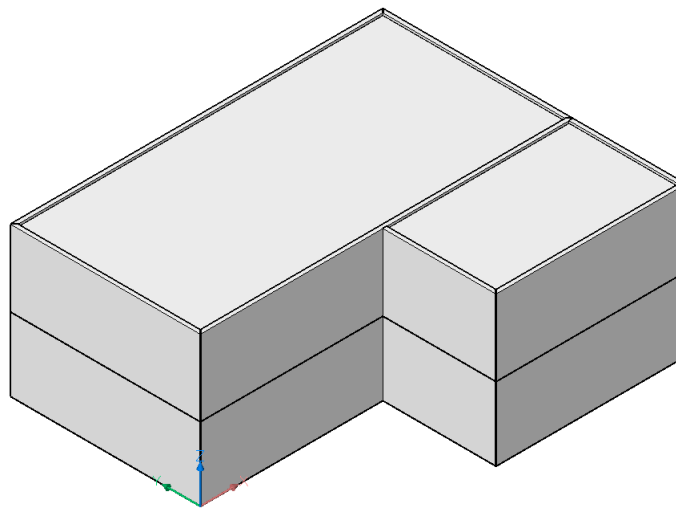

Stories and roof added by clicking the + button

You cannot subtract stories while this command is active.

STEP 2. CLASSIFY WALLS

The `bmQuickDraw` command draws the walls and slabs as 3D solids. So, the next step is to tell BricsCAD that these are in fact walls and slabs, and what they are made of (composition). You use the `bimClassify` command add IFC data to the entities.

1. Start the `bimClassify` command.

```
: bimclassify
```

```
Classify entities as [Wall/Column/Slab/Beam/window/Door/building Element/Other/Auto/  
Unclassify]: w
```

```
Select entities to classify: (Select the walls)
```

```
Entities in set: 4
```

```
Select entities to classify: (Press Enter to finish)
```

```
BIM data assigned to 4 object(s)
```

2. Repeat the command to define the horizontal solids as slabs. The entities look no different, because data is assigned to them, not a material look.

With the solids defined as walls and slabs, the next step is to define their *composition* — what are the walls and slabs made of? Here is the composition of walls typical to homes in North America:

- ▶ The **exterior sides** of walls (outdoors and indoors) consist of exterior and interior *cladding* that give walls their look. Cladding is made from bricks, wood, gyproc (drywall), and so on.
- ▶ The **interior** of walls provides strength through 2"x4" (interior walls) or 2"x6" (exterior walls) *studs* made of wood or metal. The strength of walls is needed to hold up walls, roofs, and so on. Extra pairs of 2"x6"- or 2"x10"-sized beams, called *headers*, are needed over window and door openings to distribute weight.
- ▶ **Between** the studs is insulation that retains the building's heat in winter and keeps out heat in summer. Depending on local construction bylaws, Tyvek-style wrap may be needed to keep out moisture and wind. The photo shows the white Tyvek wrap, along with a start on the brick exterior cladding.



Tyvek in white and brick cladding in brown

- ▶ Also between the walls are utilities, such as electrical wiring and plumbing, but these are not defined by compositions.

To define what walls are made of, you attach “compositions” to walls and slabs:

- ▶ Use the **BIM Compositions panel** to apply the 40 or so compositions provided with BricsCAD. You access it by right-clicking any toolbar or the ribbon, and then choosing **Panels > BIM Compositions** from the shortcut menu.

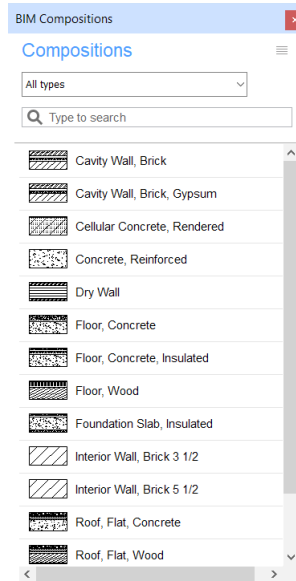

The BIM Compositions panel

- ▶ Or, you can define your own materials (and edit existing ones) with the Physical Materials dialog box. The Identity, Appearance, and Properties tabs give you control over the 2D and 3D look of each material.

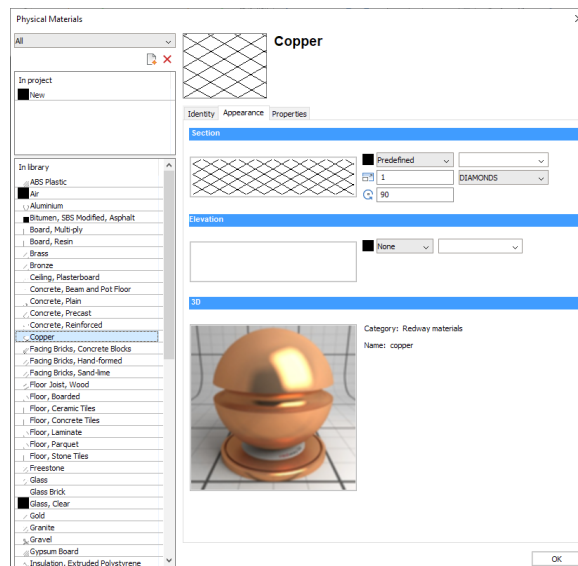

One of the tabs in the Physical Materials dialog box

You access the Physical Materials dialog box by clicking the **Open Materials Dialog** option in the BIM Compositions panel.

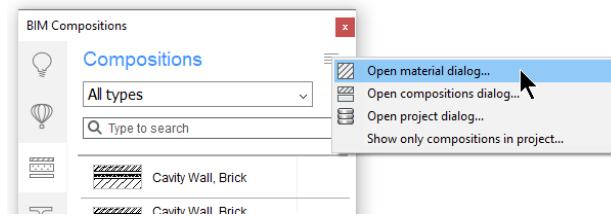

Accessing the Physical Materials dialog box

You typically combine several materials into one composition, such as brick, Tyvek, and plywood. Two or more materials are also known as a *ply*, kind of like plies (layers of materials) in tires.

As well, you would apply a different composition to the outside and inside faces of walls. In the following part of the tutorial, you apply a composition to the inside face of the walls.

3. For this project, apply the predefined “Cavity Wall, Brick, Gypsum” composition to the walls. Follow these steps:
 - a. Enter the **bimAttachComposition** command, and then choose the **Dialog** option. (NEW IN V20) The Entity option is for copying from an entity a composition already in the drawing.
 - : **bimattachcomposition**
 - Enter composition name or [Dialog/Entity] <Dialog>: d
 - b. Notice the Composition dialog box. Choose “Cavity Wall, Brick, Gypsum” and then click **Select**.

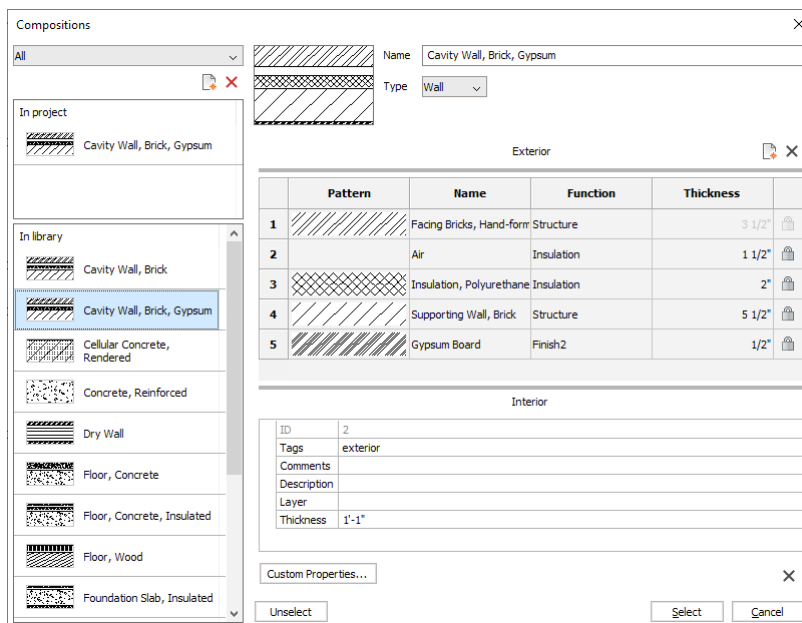

Selecting a composition for the walls

- c. Choose the four walls:
 - Select entities to attach composition: (Press **Ctrl+A** to select all walls)
 - Select entities to attach composition: (Press **Enter** to continue)

Notice that the walls have double-arrow icons. These are the ones that will have the composition applied. Click the icons to access options to specify how the composition is applied to the walls.

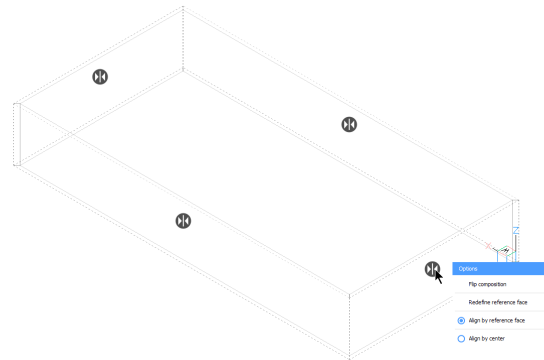

Specifying options for applying a composition

- d. Now tell BricsCAD the side of the walls on which to place the composition. “Reference face” means that when you pick the outer side of one wall, BricsCAD will place the composition on the outside of all walls in the selection set.

Choose reference face (accept):

The composition has been assigned to n element(s).

The walls will look no different. Changing the visual style to something like Modeling doesn’t show the bricks or gypsum, either. This is because you applied *data*, not a rendering material. The data tells BricsCAD (and other BIM-aware programs) the materials with which the walls are made. The data is stored in IFC format, the closest we have to a *de facto* data exchange format for architectural models.

STEP 3. ADD COMPONENTS

With the composition of the walls established, the next step is to add components like windows and doors. In this tutorial, you do it in two different ways: with the older **bimInsert** command and the newer **ComponentsPanelOpen** command. Here's the difference between the two:

bimInsert — you select a DWG file from a folder to insert as a component

ComponentsPanelOpen — you drag a component from the Components panel into the drawing

1. Add a window using the **bimInsert** command. Actually, you can use any block for a window, but we'll use one of the window blocks that BricsCAD includes.

: **biminsert**

- a. Notice the Select File to Insert dialog box. To access architectural components, navigate to |Program Files|Bricsys|BricsCAD V20|UserDataCache|Support|en_US|Bim|Components|Windows.
- b. Choose a window block, such as "Window_2x1.dwg".
- c. Click **Open**.

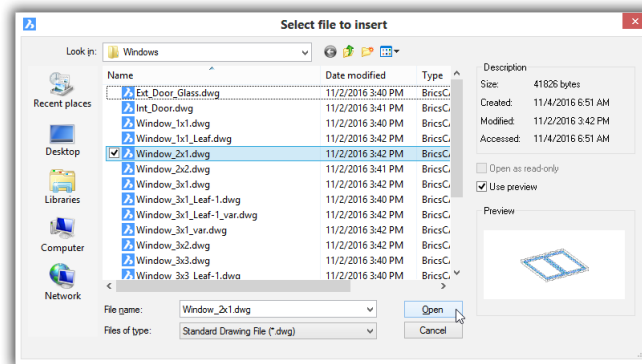

Choosing a window type

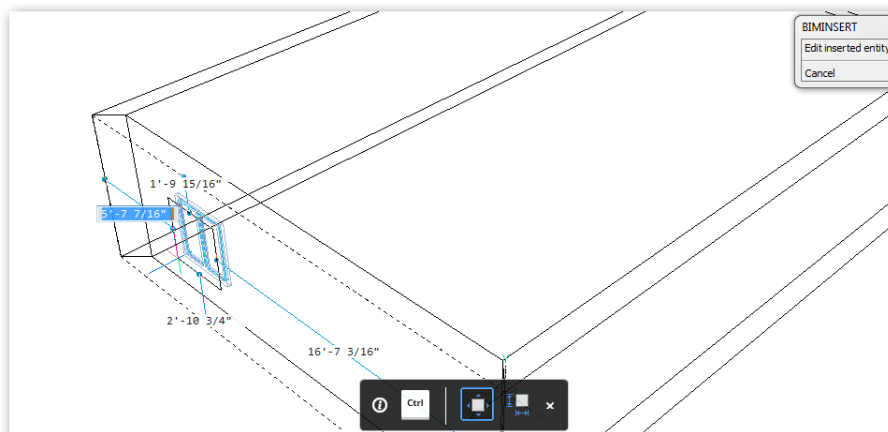

- d. Position the window block over one of the walls. Notice that dynamic UCS kicks in to force the block to be coplanar with the wall you select.



Dynamic dimensions positioning the window, with Tips bar in black

Also kicking in is dynamic input, the dimensions that appear in the drawing area to help you place the window relative to the edges of the wall. Press **Tab** to move between the dimension fields.

The Hotkey bar also appears, giving you options between **Insert** and **Edit** modes. Press the **Ctrl** key to switch between them, as follows:

Icon	Meaning
	Insert dynamically dimensions the location of the window in the wall; prompts you: <u>Select insertion point</u> or [Edit inserted entity]:
	Edit — allows you to change the size of the window; prompts you: <u>Edit Height</u> [Width/Done]:

- e. For this tutorial, just insert the window anywhere in the wall:
Select insertion point or [Edit inserted entity]: *(Click to place the window)*

Now try a different way to add elements like windows and doors. The ComponentsPanelOpen command displays the Components panel, which lists components visually. To use it, drag a component from the panel, and then pick a point to locate it in the drawing. This is a lot easier than using the bmInsert command!

PARAMETRIC SIZING

Many components (a.k.a. blocks) in BricsCAD are *parametric*, meaning you can change their sizes. For doors and windows, you can change their height and width during insertion. For the “Door Ext Glass” door being used in the tutorial, the default sizes are as follows:

Parameter	Meaning	Default Value
W	Width of door	25.000"
H	Height of door	82.667"

While inserting a component, you can change the width and height during insertion by entering the ‘e’ option, which is short for “Edit inserted entity.” Here is how to the size of the door from its default to a standard North American door size of 30" wide and 6' 8" tall:

1. Drag the door into the drawing, and then watch the command prompt area:

```

: ._-BIMINSERT
Enter file name to insert: C:\Users\login\AppData\Roaming\Bricsys\BricsCAD\V20x64\
en_US\Support\Bim\Components\Doors\Door Ext Glass.dwg
      
```
2. Enter **E** to edit the door:

```

Select insertion point or [Edit inserted entity]: e
      
```
3. Enter a new value for the height of the door, such as 6'8":

```

Edit Height [Width/Done]:(Enter a new value, such as 6'8")
      
```
4. Now enter **W** to specify a different width, such as 30":



```

Edit Height [Width/Done]: w
Edit Width [Height/Done]: (Enter a new value, such as 30")
      
```
5. When done changing the size, enter **D** and then pick the insertion point:

```

Edit Width [Height/Done]: d
Select insertion point or [Edit inserted entity]: (Pick a point in the wall)
      
```

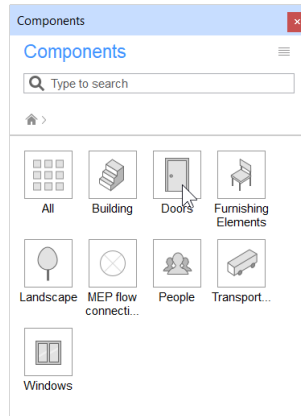
2. In this part of the tutorial, you add a door to one of the walls using the Components panel:
 - a. To open the Components panel, enter the **ComponentsPanelOpen** command. Or, it's much easier to right-click a toolbar or ribbon, and then choose **Panels > Components** from the shortcut menu.
 - b. Notice that components are grouped by type. Click **Doors**.



Components panel grouping components by type

- c. Notice the series of door types.

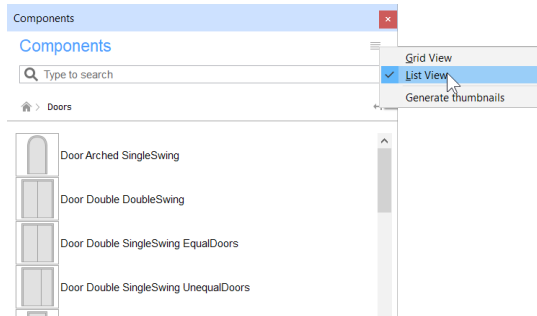

Changing the way component icons are displayed

For this tutorial, choose “Door Ext Glass.”

TIP You can change the way the icons are displayed between Grid and List view. If you know the name of a door, you can enter it in the Type To Search field.

- d. As soon as you click on the door icon, notice that it appears in Grid the drawing. Drag it to one of the walls, and then click to place it.

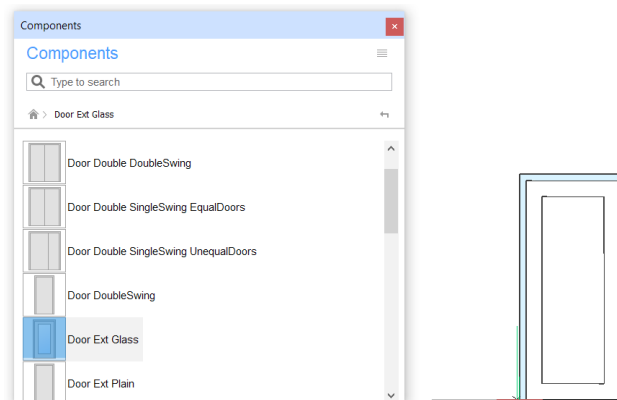

Door placed in drawing

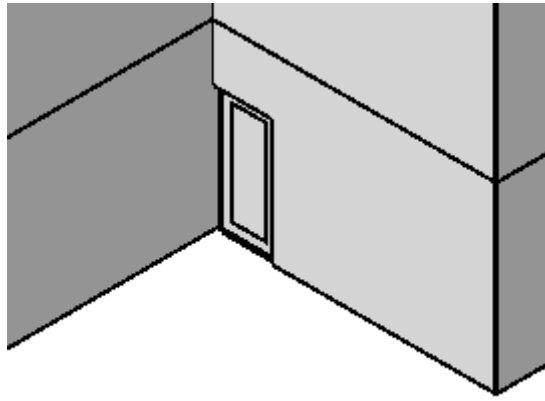

Door component placed in wall

- Once the door is in place, you can edit its parameters further through the Properties panel. Select the door, and then look at the fields under the **Parameters** section:

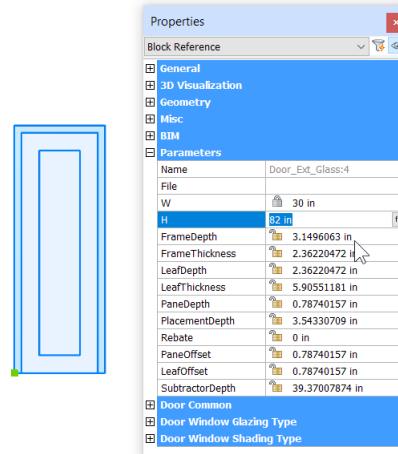

Editing parameters of door

In the figure above, you can see the gray padlock icons indicating that a value was changed, while the gold ones indicate default values. As you change values, the door in the drawing updates its sizes at the same time.

STEP 4: ADDING STAIRS

(NEW IN V20) To get from one floor to the next, you need stairs. Add a stair with the Stair command, as follows:

- Enter the **Stair** command:
: **stair**
- Place the foot of the stair:
Select first step or [Quarter-turn/Flip/Stair settings]: *(Pick a point)*

As you move the cursor around the building, notice that BricsCAD highlights in blue the floor from which the stair will start.

Notice also that the stair symbol has an arrow showing the direction the stair will take off.

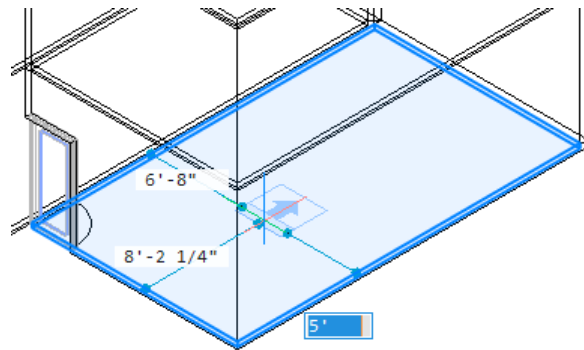

Positioning the foot of the stair

Click once you position the foot of the stair satisfactorily.

3. Move the stair cursor to the next floor. Notice that BricsCAD ghosts the position of the full stair in blue.

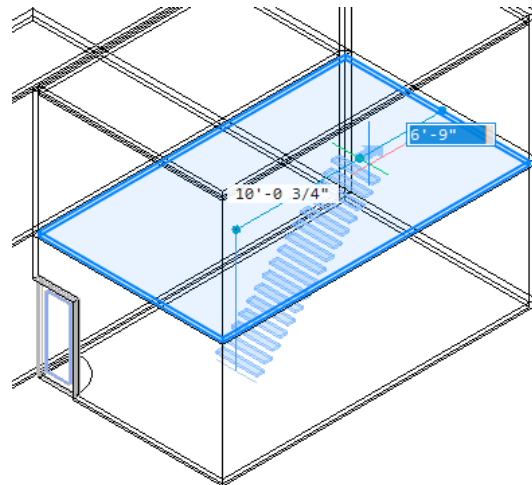

Finding the head of the stair

Click when the stair is positioned satisfactorily. Notice that BricsCAD cuts an opening in the slab, automatically.

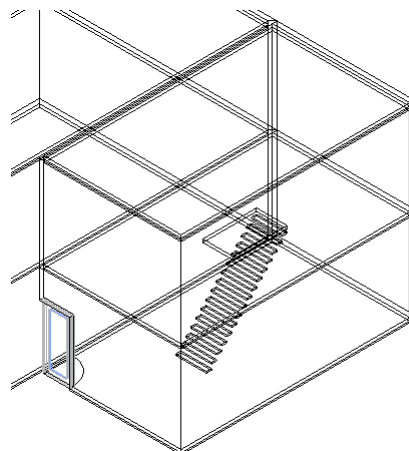

The finished stair, with opening

TIP When BricsCAD cannot find a suitable candidate for the top of the stair, the stair cursor turns red.

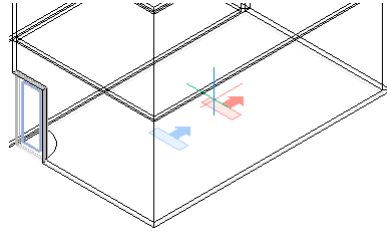

STEP 5: SHARING THE BUILDING DESIGN

All components in a BIM model use IFC (industry foundation classes), data, which was meant to be used by outside analysis software, such as thermal (heat loss and gain). Over the decades, however, IFC has developed into the primary way to share BIM models with other architectural design and viewing programs.

1. To see the IFC data of the door, open the other sections of the Properties panel. That's a lot of data!

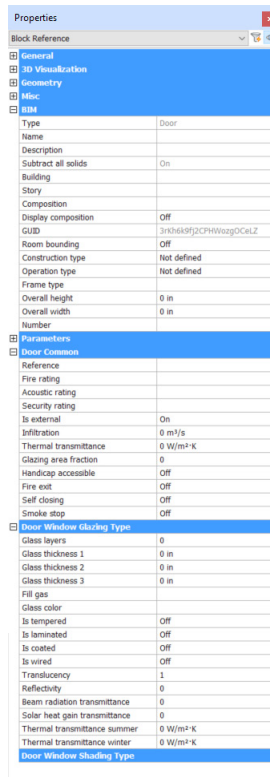

Properties panel showing IFC data for a door

2. To export the model in IFC format, use the **Export** command, and then from the **Save as Type** droplist choose "IFC file (*.ifc)".

- To view the IFC file outside of BricsCAD, use an IFC file viewer. A free one is BIM Vision, which can be downloaded from <http://bimvision.eu/en/download>. Notice that it reports the IFC data attached to each element.

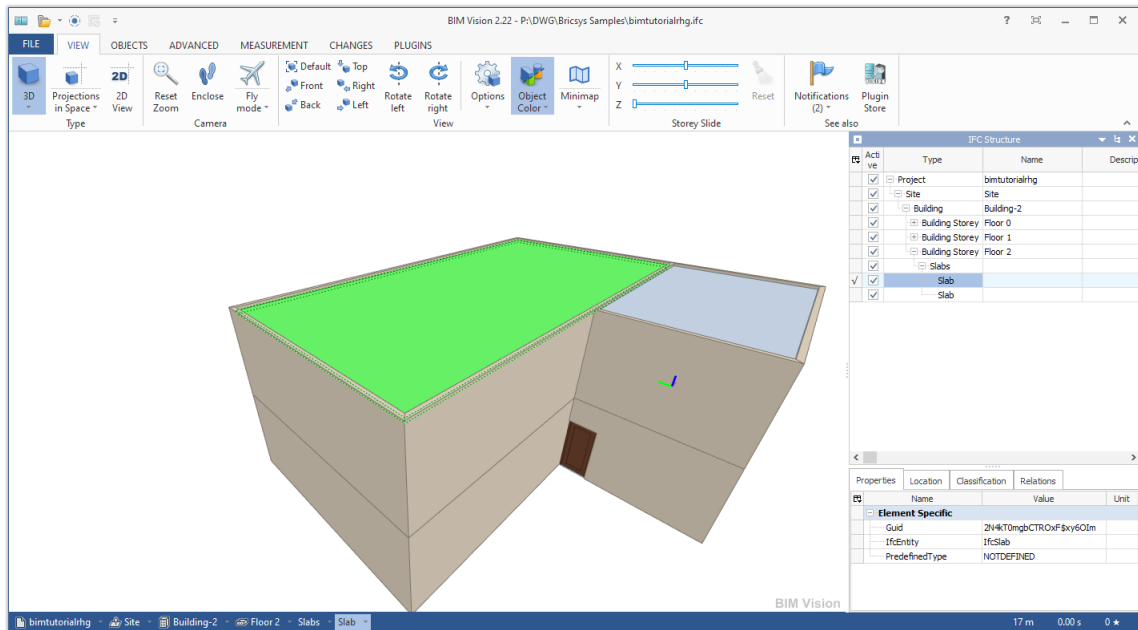

Viewing IFC data with a viewing program

Accessing BIM Commands

- ▶ Enter one the commands listed in the tutorials above
- ▶ From the **BIM** menu, choose a command
- ▶ Open the **BIM** toolbar

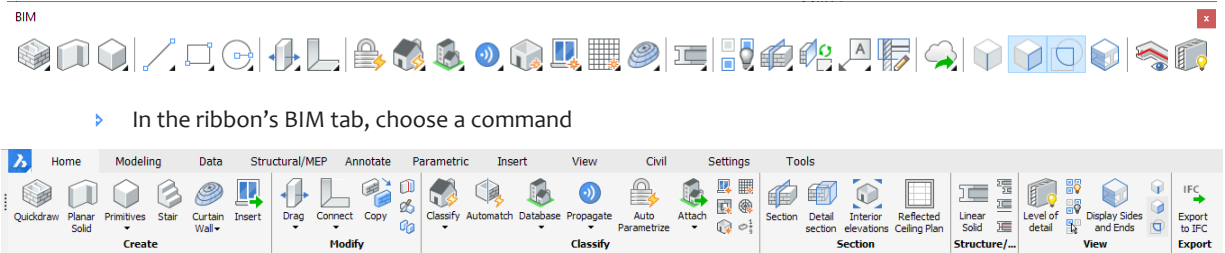

- ▶ In the ribbon's BIM tab, choose a command

As this chapter illustrates, BricsCAD is in many areas of 3D design more capable than AutoCAD. .

BricsCAD Mechanical & Communicator

BRICSYS OFFERS ADD-ON MODULES FOR SPECIALIZED FUNCTIONS IN MECHANICAL assemblies, sheet metal fabrication, and translation to and from other 3D MCAD (mechanical CAD) systems. In this chapter, we look at the following add-ons:

- ▶ **Mechanical**, including sheet metal design*
<https://www.bricsys.com/en-intl/mechanical/>
- ▶ **Communicator** export-import, including the import of assemblies and PMI data
https://www.bricsys.com/en_INTL/communicator/

*) Function is not available in AutoCAD

Each add-on module is available as a free 30-day trial from the Web page listed above. Equivalent software from Autodesk costs thousands of dollars more — other than the import-export module, which Autodesk provides to its customers for free.

This chapter describes the following aspects of 3D modeling in BricsCAD:

- ▶ 3D Assembly Modeling
- ▶ 3D Kinematic Analysis
- ▶ 3D Sheet Metal Design
- ▶ Communicator Translation

The tutorials in this chapter work only with the Mechanical or Ultimate editions of BricsCAD.

To import 3D models from other CAD packages, BricsCAD Mechanical must be running Communicator, an optional, extra-cost file translator available from https://www.bricsys.com/en_INTL/communicator/. In BricsCAD, start a new drawing, and then enter the **Import** command to select the file to import.

3D Assembly Modeling

BricsCAD Platinum creates and edits assemblies. “Assemblies” are parts that stuck together using 3D constraints to create larger, more complex models. Indeed, assemblies are impossible without 3D constraints. This same thing happens with much more expensive programs, such as Autodesk’s Inventor or Dassault’s Solidworks software. (AutoCAD cannot do this, while the Pro edition of BricsCAD is limited to displaying assemblies.)

An assembly is made from two or more parts that Bricsys calls “components.” Components are sourced from the following places:

- ▶ **Regular DWG files** — converted to components through the **bmInsert** command
- ▶ **Parts** — inserted from the Mechanical Browser’s Hardware tab with the **bmHardware** command
- ▶ **Parts drawn from scratch** — using BricsCAD’s 2D and 3D modeling commands, then converted to components with the **bmForm** command

Assemblies can contain assemblies of components. Individual components can be hidden or shown. A nice touch is that each component can have its own visual style, meaning some can be see-through and some opaque.

Accessing Assembly Commands

- ▶ Enter the commands listed in the table above
- ▶ From the **Assembly** menu, choose a command
- ▶ Open the **Assembly**, **Assembly Visualization**, and **Assembly Explode** toolbars

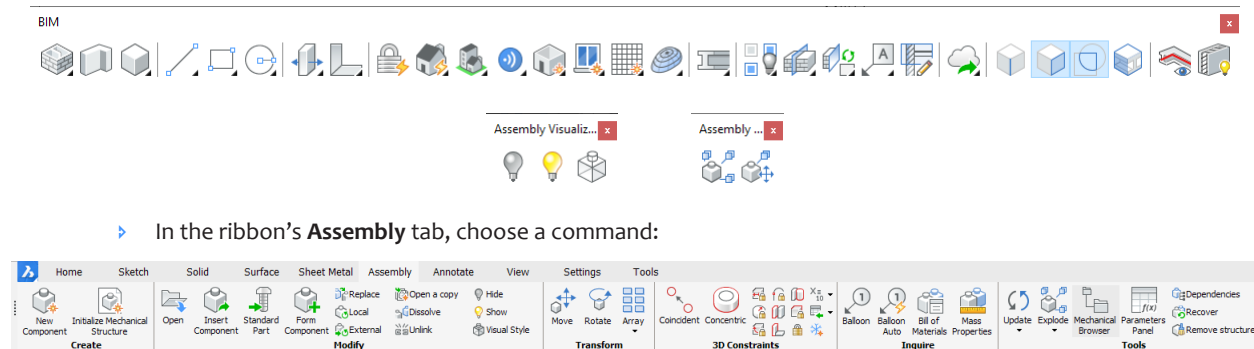

- ▶ In the ribbon’s **Assembly** tab, choose a command:

WORKING WITH ASSEMBLIES

In this tutorial, you create a simple assembly of two parts: a pin and a piston. Step 3 is the critical step in this tutorial, because this is where you turn the regular drawing into an assembly drawing.

1. Start BricsCAD in the **Mechanical** workspace.
2. Open the Mechanical Browser bar with the **MechanicalBrowserOpen** command.
3. To turn the plain DWG drawing into an assembly drawing, follow these steps:
 - a. In the Mechanical Browser, click the **Name** field (located near the bottom of the browser).
 - b. Edit the text so that “Drawing1” reads **Piston Head**.

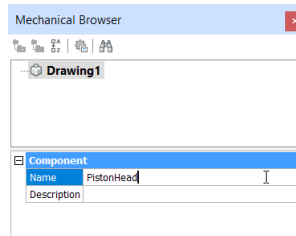

Drawing renamed by the Mechanical Browser

- c. Notice that BricsCAD changes the name of the drawing to match. Press **Ctrl+S** to save the drawing.

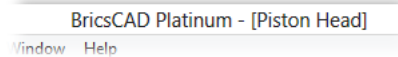

Drawing renamed in the title bar

Yup, that’s all it takes to prepare the drawing for assemblies.

4. The next step is to insert a pre-drawn component into the drawing. Follow along:
 - a. Choose the **Assembly** tab in the ribbon, and then click  **Insert Component**.



Assembly tab for inserting components

Notice the Insert Component dialog box.

- b. Navigate to the *Samples* folder to access mechanical drawings provided with BricsCAD:
C:\Program Files\Bricsys\BricsCAD V20\en_US\Samples\Mechanical\piston

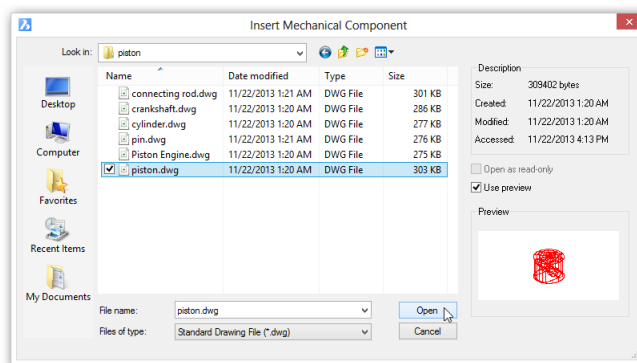

Choosing a DWG file to insert as a component of an assembly

- c. Select the *piston.dwg* file and then click **Open**.
- d. Place the piston at any convenient spot in the drawing; the exact location is immaterial.

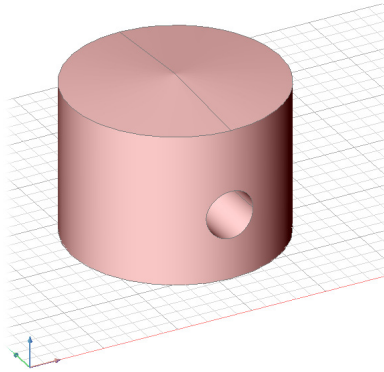

Piston placed as a component in the assembly drawing

5. Repeat **Insert Component** to place *pin.dwg* as the other component. Insert it next to the piston.

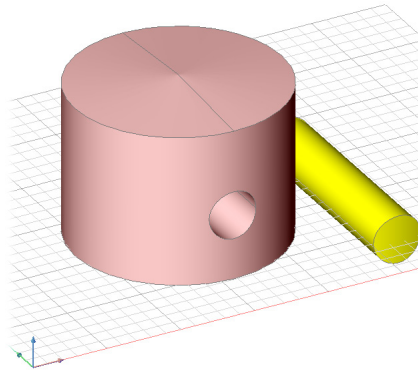

Pin added to the assembly drawing

6. With the two parts in the drawing, you can attach them to one other. This is done by with 3D constraints. Working in 3D takes pre-planning, and so let's think through what is needed:
 - ▶ You want the pin to stay inside the piston head
 - ▶ The pin must be free to rotate inside, but it cannot slide out of the piston

To accomplish this goal, you need two 3D constraints:

Concentric constraint keeps the pin centered inside the hole of the piston (but allows the pin to slide out of the piston)

Tangent constraint keeps the pin from leaving the piston

- a. In the 3D Constraints panel of the Assemblies tab, Click  **Concentric**:



3D Constraints panel for attaching components

: `dmconcentric3d`

- b. Pick a curved face (a.k.a. subentities) from the piston:
 Select a pair of subentities: (Hold down the **Ctrl** key, and then pick a curved face of the pin, highlighted in blue on the yellow part shown in the figure below)
 Entities/subentities in set: 1
- c. ...and then pick a curved face on the pin:
 Select a pair of subentities: (Hold down the **Ctrl** key, and then pick the curved inside face of the piston, also highlighted in but on the pink part)

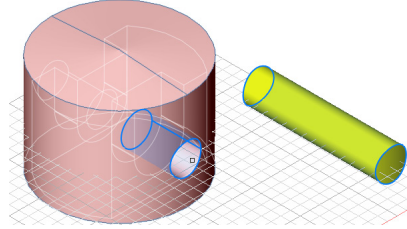

Selecting curved surface to make components concentric

Should you have difficulty picking the correct face with the cursor, press the **Tab** key to cycle through all possible surfaces under the cursor.

The command ends automatically after you pick the second subentity. Notice that the pin jumps over to the opening of the piston. The pin is inside the piston; now you use the Tangent constraint to keep the pin from sliding out of the piston.

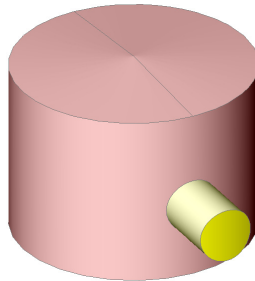

Concentric constraint lines pin up with piston's opening

- d. To shove the pin inside the piston, making its ends flush with the piston walls, use the  **Tangent** constraint and pick the two subentities described here:

: **dmTangent3d**

Select a pair of subentities: (Hold down the **Ctrl** key, and then pick one end of the pin; see blue outline in the figure below)

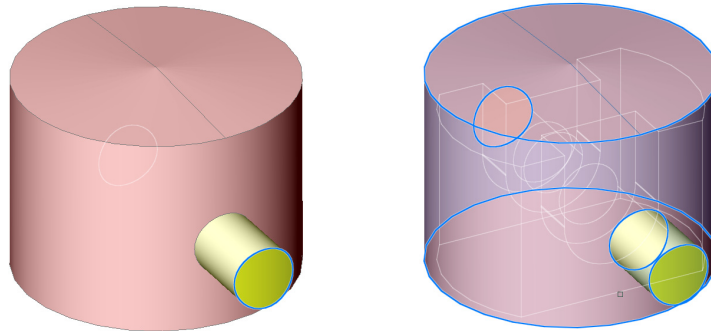

Left: Selecting an end of the pin as the first tangent surface; **right:** Selecting the outside of the piston as the second tangent surface

Entities/subentities in set: 1

Select a pair of subentities: (Hold down the **Ctrl** key, and then pick the outside of the piston, shown outlined in blue in the figure above)

The constraint snaps the pin inside the piston.

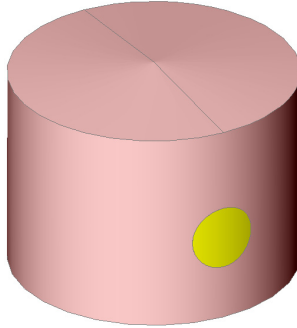

Pin snug inside the piston

7. Look the content of the Mechanical Browser bar. It lists the two components (Piston:1 and Pin:1) and the two constraints used.

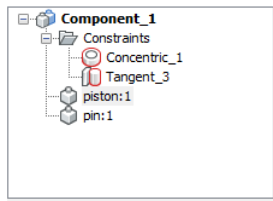

Mechanical Browser listing the components and constraints of this assembly

To remove a constraint, right-click its name, and then choose **Delete**.

With the parts are attached to one another, they form an assembly. After this, simple kinematic analysis can be applied to the assembly, such as rotating and moving (sliding) parts. See section below. As well, the assembly drawing can be turned into 2D drawings and sections. Both of these tasks are described later in this chapter.

Mechanical components are stored in .dwg files as custom objects. While they can be opened and viewed in AutoCAD, the constraints do not translate, because Bricsys and Autodesk use different code for constraints.

3D Kinematic Analysis

BricsCAD Platinum can perform two kinds of kinematic analyses — rotating and sliding parts that are being held together in assemblies with 3D constraints. *Kinematic analyses* animates assemblies to show you how the parts move;

The analysis does not, however, perform collision detection. *Collision detection* determines if any of the moving parts would collide with one other. (AutoCAD has neither function.)

Kinematic Analysis Commands

dmRotate	Rotates entities and sub-entities
dmMove	Moves entities and sub-entities

MOVEMENT ANALYSIS

To see how kinematic analysis works in BricsCAD, open *Piston Engine.dwg*, a sample drawing provided with BricsCAD. (You'll find it in the *C:\Program Files\Bricsys\BricsCAD V20\en_US\Samples\Mechanical\Piston* folder.) This assembly drawing is complete, with all of the components held in place with 3D constraints. See figure below.

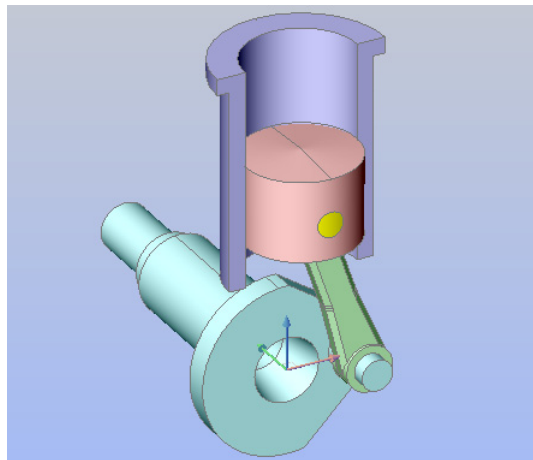

Sample drawing provided with BricsCAD

In this sample drawing, you rotate the parts of the mechanism with the **dmRotate** command. Start the command with the Quad cursor, like this:

1. Move the cursor over the crankshaft, and then wait a second for the Quad cursor to show up. Notice that the crankshaft is outlined in blue, which indicates the Quad cursor has selected it.

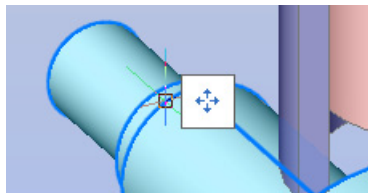

Quad cursor appears over selected entity

2. Move the arrow cursor over the single icon; notice that the Quad cursor expands to five icons.

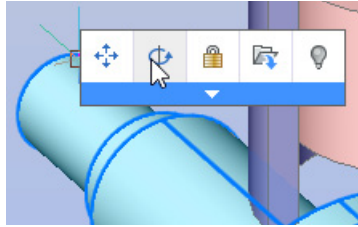

Selecting the Rotate command from the expanded Quad cursor

3. Choose the **Rotate**  command.
4. Notice the prompt at the command line:

```
: dmRotate  
Select several entities/subentities: Ctrl+A (to select all entities)  
Select edge or line as axis or define axis by <2Points>/Xaxis/Yaxis/Zaxis: y
```

Enter **y** for the y axis option. This is a clever shortcut, because the center of the crankshaft lies exactly along the y axis, as you can tell from the UCS icon in the figure below.

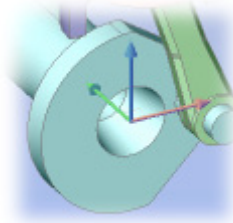

Crankshaft's centerline laying along the y axis

5. To start the rotation, pick a point anywhere in the drawing; the point you pick is not important, but further away from the y axis gives you finer control.
Pick start point in the rotation plane (*Pick a point.*)
6. Move the mouse to rotate the mechanism:

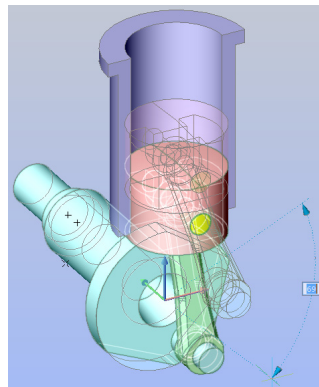

Crankshaft, link, and piston move together

Notice how the engine operates: as you move the mouse, you change the rotation angle of the crankshaft, causing all linked parts to rotate in tandem.

3D Sheet Metal Design

Sheet metal design begins with 2D profiles or 3D models, including those imported into BricsCAD from other MCAD systems. BricsCAD Platinum creates, bends, and unbends sheet metal designs with the Mechanical edition.

TUTORIAL I: HOW SHEET METAL DESIGN WORKS

This tutorial takes you through the fundamental steps using a 2D profile:

1. Start BricsCAD with the Mechanical workspace.

Step 1. Create Sheet Metal

A sheet metal part is created from existing entities.

2. Draw the shape shown below as a closed polyline:
 - a. Draw a rectangle with the **PLine** command.
 - b. Add the four “openings” with the **Circle** command.
 - c. Convert all five entities into region entities with the **Region** command.

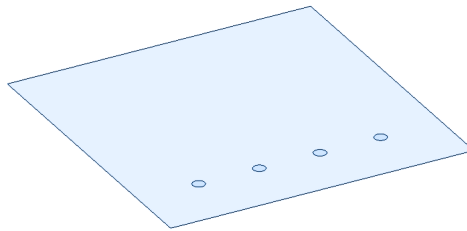

Rectangle and four circles converted to a region entity

- d. Use the **Subtract** command to remove the circles from the plate, turning them into holes.

THE COLOR OF SHEET METAL

BricsCAD uses a color coding system to identify features in sheet metal parts. For example, bends are shown in yellow, and corner reliefs (openings) are bright green. The colors listed below are found in the Settings dialog box's Sheet Metal | Feature Colors section.

Feature colors	
Feature colors	<input checked="" type="checkbox"/> Toggle feature colors
Flange feature color	(144,164,174)
Flange feature reference side color	(104,164,174)
Form feature color	(135,145,225)
Bend feature color	(255,220,80)
Lofted bend feature color	(160,220,250)
Wrong bend feature color	(255,51,0)
Bend relief feature color	(100,210,150)
Corner relief feature color	(100,210,150)
Junction feature color	(255,110,64)
Miter feature color	(175,70,216)

To turn off the coloring system, change the value of the **FeatureColors** variable to Off.

3. Use the Quad cursor to start the **smFlangeBase** command, like this:
 - a. Pausing the cursor over the region entity.

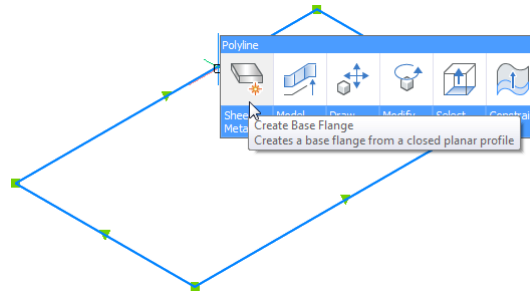

Using the Quad cursor to start the smFlangeBase command

- b. Notice that the Quad appears. (If not, then click **QUAD** on the status bar to turn it on.) Move the cursor over the **Create Base Flange** icon.
 - c. Click the **smFlangeBase** button. BricsCAD instantly turns the region into a sheet metal object. You can tell this has happened, because the region thickens.

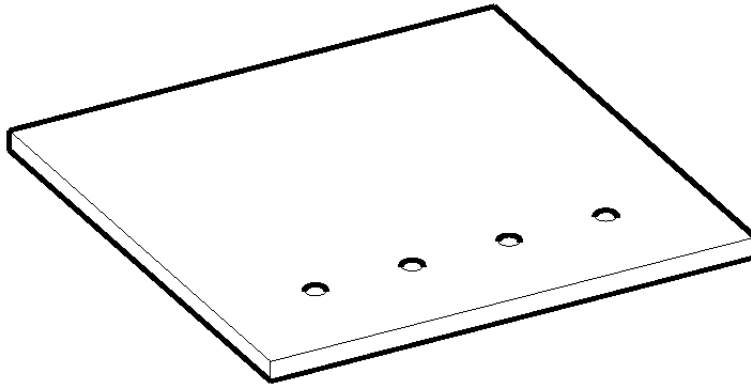

The smFlangeBase command thickens the region into a base

- d. Press **Enter** to end the command:

```

: _smFlangeBase
Entities in set: 1
Make flange base [Up/Middle/Down/Accept model] <Accept model>: (Press Enter)
          
```

The object is now a 3D solid face that BricsCAD recognizes as a sheet metal entity, called a *base*.

Step 2. Add Flanges

You add sides to the base to make things like boxes out of sheet metal. For this, you use the **smFlangeEdge** command to add sides to the base. Sides in sheet metal are known as *flanges*, and they are pulled out from the base.

4. Start the **smFlangeEdge** command and then pick edges for the flanges like this:

```

: smFlangeEdge
Select one or more edges of existing flanges: (Pick an edge)
Entities/subentities in set: 1
      
```

Select one or more edges of existing flanges: *(Pick an adjacent edge)*
 Entities/subentities in set: 2
 Select one or more edges of existing flanges: *(Press Enter to end edge selection)*

Notice that BricsCAD adds sides (flanges) to the base. The command extends the length and width of the base. In the next step, you specify the height and angle of the two flanges.

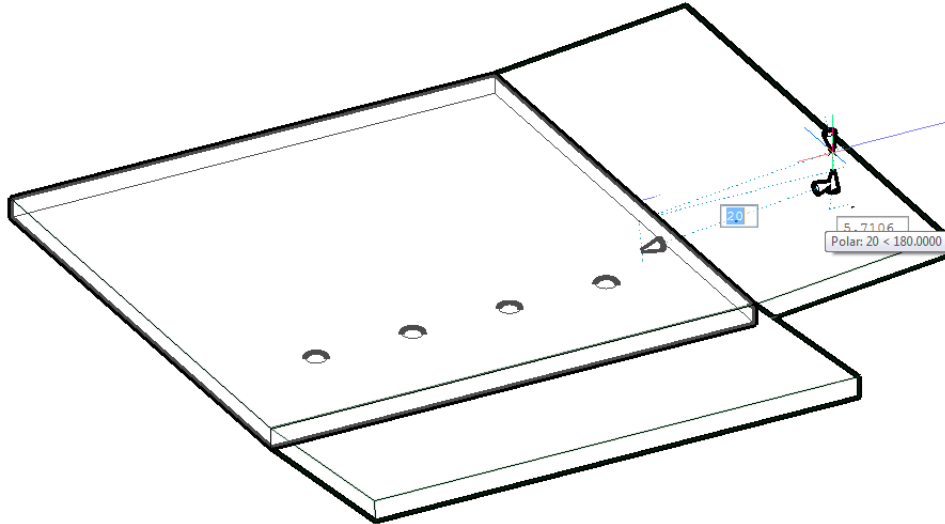

Two edges selected to bend

5. You can just move the mouse to indicate the length of the bend, or else enter a value at the keyboard. You can also specify the angle:

Position the end of the flange [Angle/Length/Taper angle/Width]: *(Move the mouse to indicate the angle, or enter values)*

Position the end of the wall [Angle/Length/Radius/Toggle connection]: a

Enter bend angle <Back>: 90

Position the end of the wall [Angle/Length/Radius/Toggle connection]: 1

Enter length of wall <Back>: 10

Position the end of the flange [Angle/Length/Radius/Toggle connection]: *(Press Enter to end the command)*

Notice that the command adds bends, bend reliefs, and corner reliefs automatically. Reliefs are needed to compensate for the metal bending process.

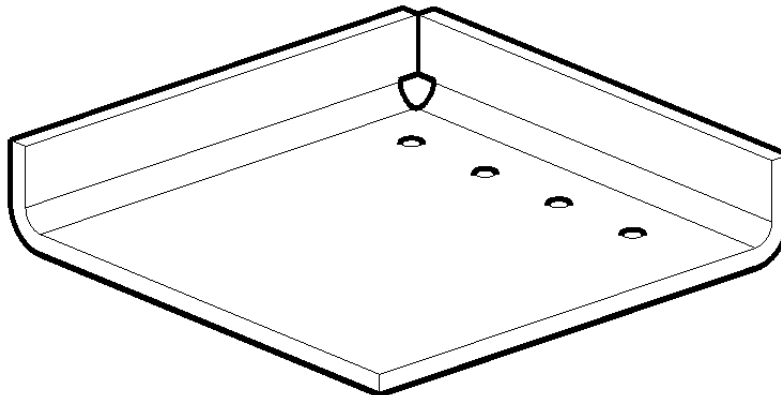

Flanges bent into place

6. Should you wish to change the angle of a flange, use the **smFlangeRotate** command. Pick a face on the flange to be bent, as follows:

: **smFlangeRotate**

Select a flange face to rotate: (*Pick a face -- not an edge! -- and then move the mouse to show the new angle*)

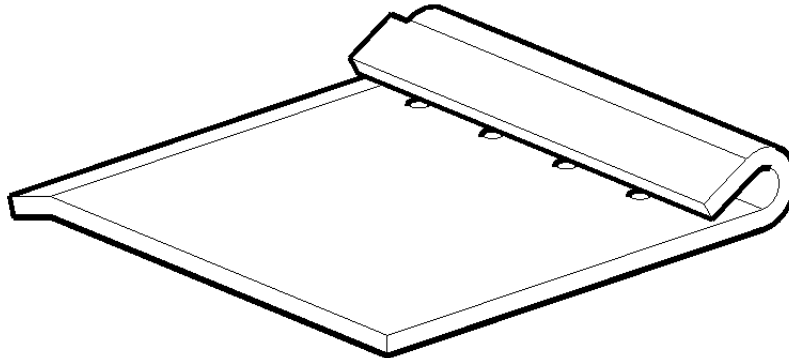

Changing the angle of flanges

TIP You can use any of BricsCAD's direct modeling and 3D constraints commands with sheet metal parts. In addition, you can control parts with user-defined parameters, such as material thickness and bend radius.

Step 3. Unfold Sheet Metal

For a sheet metal design to be manufactured, it needs to be flattened out. The 3D design must be flattened, because the manufacturing process starts with a flat piece of metal. Drills add holes, and presses bend the metal.

In BricsCAD, sheet metal designs are unfolded with the **smUnfold** command, and performs two jobs:

- ▶ Generates a 2D drawing of the sheet metal part
- ▶ Optionally exports the drawing in DXF format for use with CAM (computer-aided manufacturing) systems

7. Start the **smUnfold** command from the Quad cursor:

: **smUnfold**

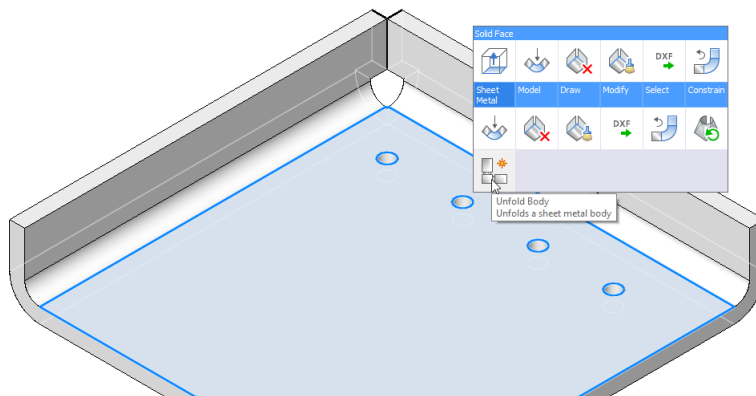

Accessing the smUnfold command

- Pick a point in model space in which to place the flattened representation. If necessary, use transparent pan and zoom to make sufficient room away from the 3D model.

Select a flange or lofted bend face to start unfolding [Associative]: *(Pick any part of the sheet metal)*

Select position of the unfolded body: *(Pick a point in the drawing away from the 3D model)*

Validate the unfolded body and select an option [save 2D geometry/save 3D geometry/Optimize bend annotations/Keep] <Keep>: *(Enter an option; see table below)*

smUnfold Option	Meaning
save 2D geometry	Saves 2D geometry as a DWG file
save 3D geometry	Saves 3D model as a DWG file
Optimize bend annotations	Optimizes bend annotations in the exported geometry
Keep	Places unfolded 3D solid in the current drawing.

The result of the unfolding process looks like this. BricsCAD adds the dimensions automatically.

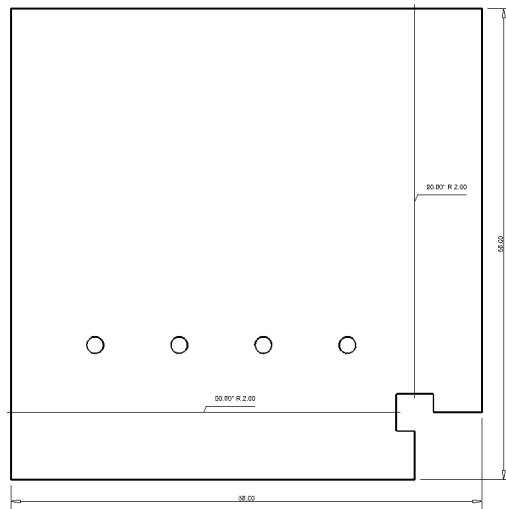

Annotated 2D drawing of the sheet metal part

If you wish, use the Mechanical Browser to access the parts of the sheet metal part:

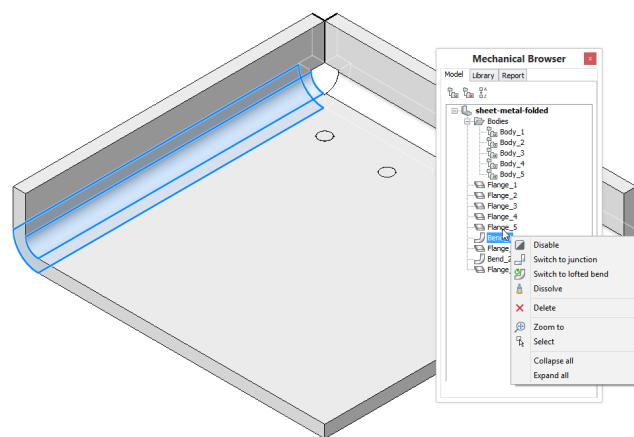

Clicking a node in the browser highlights the related part in the model

TIP To turn the circles into holes, use the **dmExtrude** command. Because BricsCAD Platinum features design intent, you need to only extrude the one hole; BricsCAD recognizes the other three as having the same diameter, and so turns them into holes automatically!

ADDING FORM FEATURES

Forms are parts commonly added to sheet metal designs, such as louvers for ventilation and embossed holes for countersunk screws. BricsCAD provides a library of forms as 3D parametric blocks so that you don't need to draw them repeatedly. They are found in the Tool Palettes panel's Form Features tab.

You use them like this:

1. Open the Tool Palettes with the **ToolPalettes** command, and then click the **Form Features** tab.

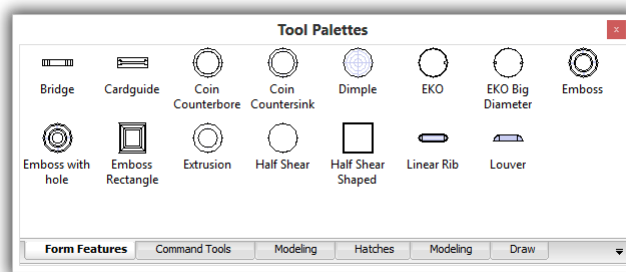

Form features in the Tools Palette panel

2. Drag a feature onto the sheet metal piece. Behind the scenes, BricsCAD runs the **bmInsert** command:

```
._-bminsert
Enter file name to insert: C:\Users\ralph\AppData\Roaming\Bricsys\BricsCAD\
V20x64\en_US\Support\DesignLibrary\Sheet Metal\Form Features\Emboss_with_hole.dwg
Select insertion point or [Edit inserted entity/Rotate component/set Base point/
Name/insertion Type/Flip/mUltiple] <0, 0, 0>:_U
Select insertion point or [Edit inserted entity/Rotate component/set Base point/
Name/insertion Type/Flip/Array]: (Pick points to place the feature, or press
Enter to end the command)
```

3. Pick a point to place the feature. After it is placed, you can place more features, as the command continues until you press **Enter**.

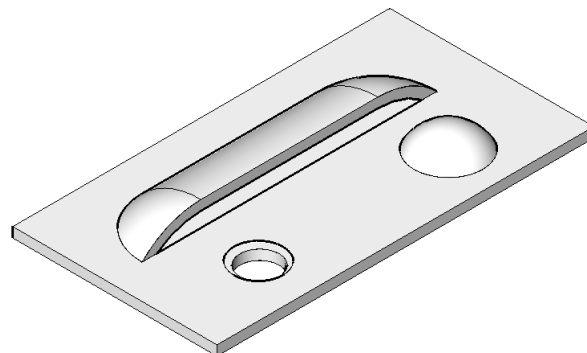

Louver, countersink, and dimple placed on sheet metal

To control the appearance of form features in 2D and 3D unfolded model representations, change the value of the **smDefaultFormFeatureUnfoldMode** variable through the Settings dialog box:

smFormFeatureUnfoldMode	Meaning
0	Keep
1	Remove
2	Project
3	Contour
4 (default)	Symbol

BricsCAD recognizes form features in geometry imported from other CAD systems. BricsCAD stores the features as individual .dwg files in the following folder: *C:\Users\login\AppData\Roaming\Bricsys\BricsCAD\V20x64\en_US\Support\DesignLibrary\SheetMetal\FormFeatures*.

Exporting Sheet Metal Parts

CNC machines typically read DXF files to produce parts. Use the **smExport2D** command to export sheet metal designs as 2D profiles in DXF format to as far back as Release 9.

The **smTargetCAM** system variable specifies the CAM system to which to export.

TUTORIAL II: FROM 3D SOLID TO SHEET METAL

The above tutorial showed you how to create a sheet metal part from scratch. This approach is best for simple parts.

BricsCAD has, however, a second approach: it can create sheet metal models from existing 3D solids, which is the better approach for complex parts. (Expensive MCAD programs like Solid Edge and Solidworks also have this ability, but AutoCAD does not.)

Bricsys says BricsCAD has a distinguishing feature: in the other two MCAD programs, the basic feature is an inseparable flange+bend, whereas in BricsCAD's flanges and bends are independent. For most changes, users of the other two MCAD programs must restart from scratch; furthermore, they cannot split the model in several bodies, something that may be required when working with sheet metal designs.

In this tutorial, you defeature an solid model, and then convert it to a sheet metal part. *Defeaturing* means removing parts that can't be used in sheet metal stamping, such as pins, or parts that need to be replaced, like fillets with bends.

Defeaturing is done with the assistance of two functions, *smart selection* and *subtraction extrusion*.

- ▶ **Smart selection** — select all parts that are identical; performed by the **dmSelect** command. You choose one feature, such as the face of a peg, and it selects all other identical faces in the mode.
- ▶ **Subtraction extrusion** — is when you remove the pegs by subtracting them with the direct modeling version of the Extrude command, **dmExtrude**.

1. Start BricsCAD in the **Sheet Metal** workspace, and then open the sample file *startfromsolid.dwg*.

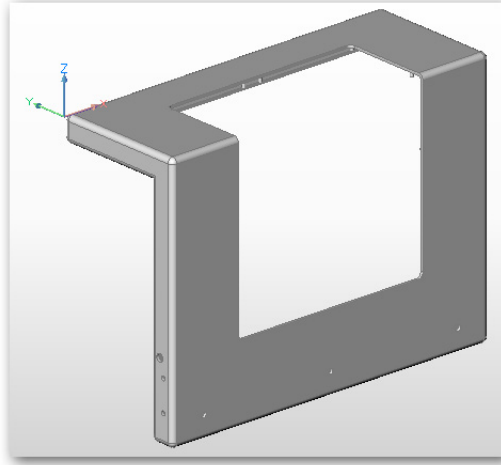

Solid model with pins and filleted corners

2. Here is the first step of defeaturing, smart selection. While you could perform smart selection at the command prompt, it is much easier using one of these icons:

- ▶ From the Quad cursor, choose **Select > Same Area Faces**

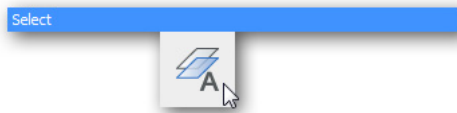

Choosing the Same Area Faces command from the Quad

- ▶ Or, in the Sheet Metal ribbon's **Select** panel, click the **Same Area Faces** button

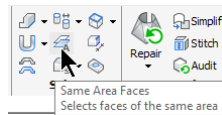

Finding the Same Area Faces button on the ribbon

3. Ignore the plural nature of the 'Select several entities' prompt by selecting the face of just one pin:

Select [subset/Sample/sEed] <Sample>: (Press **Enter** to accept the default, *Sample*)

Select several entities/subentities: (Pick the face of a pin)

Make sure that you select the *face*, and not the *edge*. (If you select the edge of the pin, then BricsCAD selects all other edges in the model, which you don't want.)

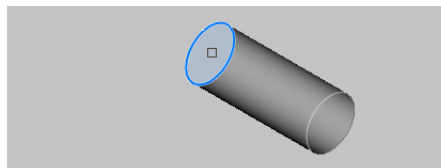

Selecting the face of one pin...

Notice that BricsCAD selects all other pin faces that are the same.

4. With the pin faces selected, use the **dmExtrude** command to remove the pins. Again, I recommend using the Quad or ribbon, as they automate some of the options you would otherwise specify at the command prompt.
 - a. From the Sheet Metal ribbon's **Edit** panel, choose **Extrude**. Notice that BricsCAD fills in the first two prompts for you — set mode to solid:

```

          : dmExtrude
          Select entities/subentities to extrude or set [M0de]: _MO
          Choose type of created entity [S0lid/SURface] <Solid>: _SO
          
```
 - b. Specify 's' for the Subtract option:



```

          Specify height of extrusion or set [Auto/Create/Subtract/Unite/Taper angle/Limit]
          <Create>: s
          
```
 - c. Press **Enter** to end the command:

```

          Specify height of extrusion or set [Auto/Create/Subtract/Unite/Taper angle/Limit]
          <Subtract>: (Press Enter to end the command)
          
```

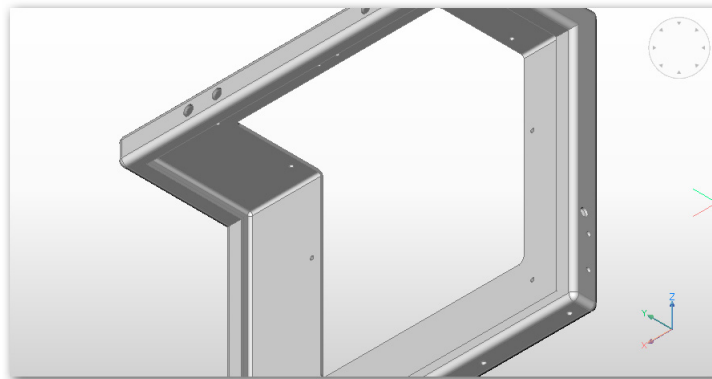
Notice that all the pins in the model disappear instantly. They are replaced by holes. These will be stamped during the sheet metal manufacturing operation, after which pins are added during a separate step.



Pins removed from solid model

5. The other preparatory step is to remove the fillets so that the edges can be turned into proper bends. Again, it is a two-step process: first select all fillets with dmSelect, and then erase them with the Erase command.
 - a. From the Sheet Metal ribbon's **Select** panel, choose the **Same or Less Radius Fillets** icon.

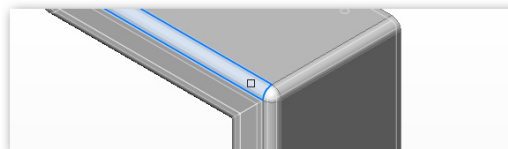

Selecting a fillet

- b. Choose a fillet. Notice that BricsCAD selects all the other fillets on the model, as shown in blue in the figure below.

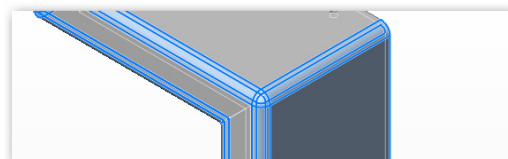

All fillets selected in the model

- c. At the command prompt, enter **Erase** to erase all fillets. Notice that all corners become sharp.

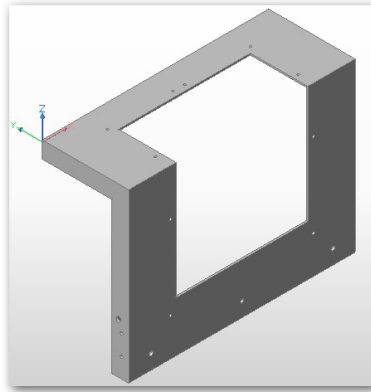

Fillets removed from the solid model

6. With the solid model defeatured, you now convert it to a sheet metal part with the smConvert command.



From the Sheet Metal ribbon's **Create** panel, choose **Convert to Sheet Metal**.

: **smConvert**

Select 3D solids/<Entire model>: (Press **Enter** to select the entire model)

At the prompt, pressing **Enter** selects the entire model. The model looks no different, except that it takes on a gray color. From now on you edit it with commands that start with 'sm', short for "sheet metal."

7. Convert all hard edges to bends. *Hard edges* are the ones with sharp edges. This process takes two steps: firstly, select all hard edges with the smSelectHardEdges command, and then turn them into bends with the smBend command. Here are the steps:



- a. From the Sheet Metal ribbon's **Select** panel, click on **Hard Edges**. Notice that all hard edges are selected by BricsCAD, because they turn blue.

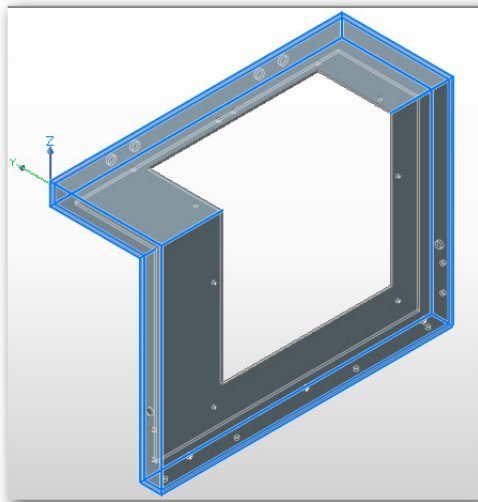

All hard edges selected by BricsCAD



- b. Change the hard edges to bends. From the Sheet Metal ribbon's **Modify** panel, click **Bend**. Notice that the hard edges are replaced by bends, complete with cutouts at intersections. The bends are colored so that you can distinguish them visually from other sheet metal features.

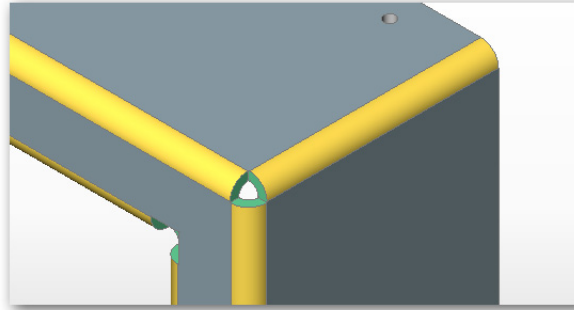

Bends (in yellow) complete with cutouts (in green) at intersections

8. The ultimate aim of sheet metal design is to produce a result that can be fully flattened, and so you need to fix up some corners manually by splitting flanges with the smFlangesplit command. Here's how:
- Zoom into a corner for a closer look with the **Zoom Window** command.
 - Make sure that esnaps (entity snapping) are turned on. If necessary, click the **ESNAP** button on the status bar.



- c. From Sheet Metal ribbon's **Modify** panel, click the **Split** button. Follow its prompts on the command line:

: smFlangesplit

Select a flange face: *(Pick a face)*

Select lines, edges to split the flange or draw a <New line>: n

Start point of the line: *(Use ensap to pick one corner; see figure below)*

End point of the line: *(Use ensnap to pick the other corner)*

Make split Center/Left/Right/<Accept model>: *(Press Enter to end the command)*

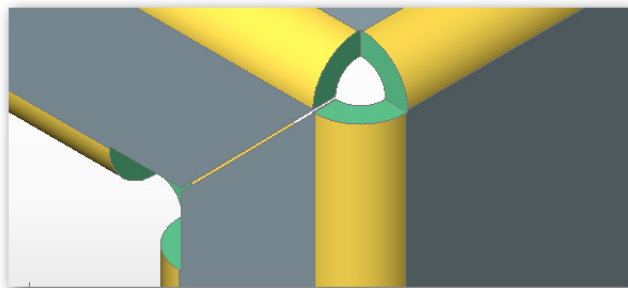

Splitting a flange

- d. Repeat for the other faces that need splitting.

9. A few other corners need to be turned into junctions. This is done with the `smJunctionCreate` command, as follows:



- a. From the Sheet Metal ribbon's **Modify** panel, click **Junction**.
- b. Pick a yellow-colored bend, such as the one outlined in blue, below.

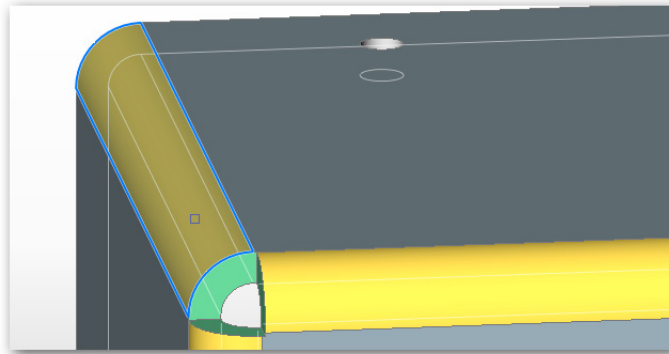

Selecting a bend (outlined in blue)...

- c. Notice that the bend immediately turns into a junction colored red. The command repeats automatically so that you can turn other bends into junctions. Continue making the change as required.

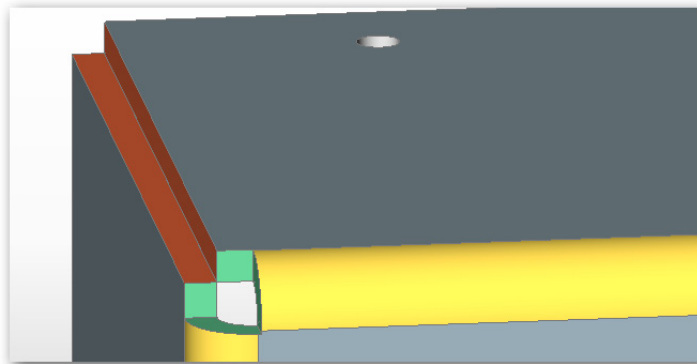

...and turning it into a junction (shown in red)

10. The junction needs to be edited so that one edge cleanly meets the other. You do this with the `smJunctionSwitch` command, as follows:



- a. From the Sheet Metal ribbon's **Modify** panel, choose the **Junction Switch** button.
- b. Select one of the red faces, and then press **Enter** to end the command:

: smJunctionSwitch

Select junction(s) face(s): *(Pick one red face, as shown below)*

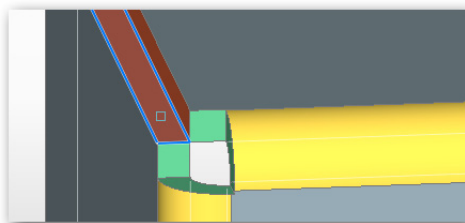

Selecting a face (in red)...

- c. Press **Enter** to end the command.

Entities in set: 1

Select junction(s) face(s): (Press **Enter** to end the command)

Notice that BricsCAD extends one face to meet the other one automatically, as shown below:

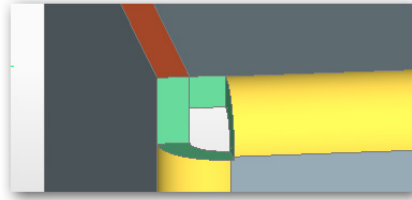

..to make the edges match perfectly

- d. Repeat for other junctions that need to be switched.
11. With the solid model properly prepared as a sheet metal part, it can be unfolded — the last step necessary before it is exported as a DXF or other file for stamping by CNC machinery. Unfolding is done with the smUnfold command.



- a. From the Sheet Metal ribbon's **Flatten** panel, choose the **Unfold Body** button. At the prompt, just pick any point on the sheet metal body:

: smUnfold

Select a flange or lofted bend face to start unfolding [Settings]: (Pick a point on the body)

- b. Pick a point in the drawing to place the unfolded sheet metal, and then enter **Keep** to end the command:

Select position of the unfolded body: (Pick a point in the drawing)

Validate the unfolded body and select an option [save 2D geometry/save 3D geometry/export to Jetcam/Optimize bend annotations/Keep] <JetCam>: **keep**

Notice that BricsCAD automatically dimensions the flat part.

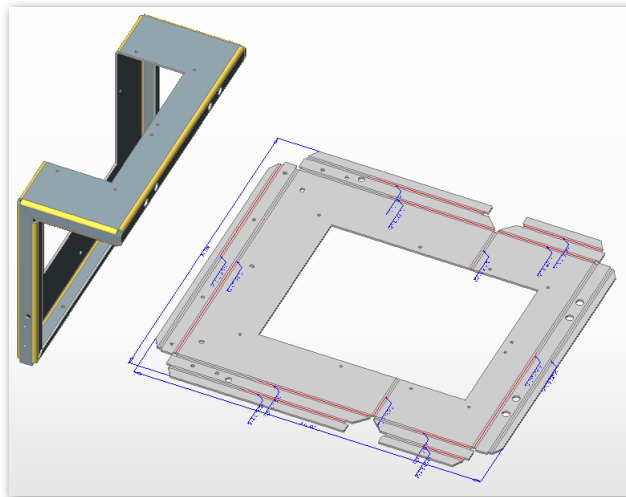

3D model flattened, ready for export to CNC machinery

Accessing Sheet Metal Commands

- ▶ Enter one the commands listed above
- ▶ From the **Sheet Metal** menu, choose a command
- ▶ Open the **Sheet Metal** toolbar



- ▶ In the ribbon's **Mechanical** tab, choose a command from the **Sheet Metal Tools** panel:

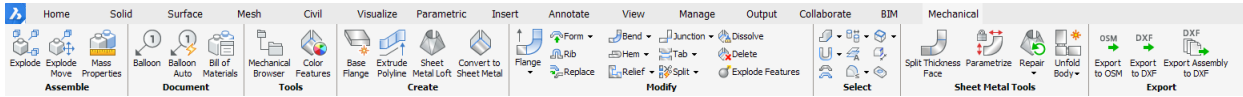

Communicator Translation

BricsCAD Communicator is an optional, extra-cost add-on to BricsCAD that provides additional import and export formats. It costs extra, because of the license fees that need to be paid to the firms that write the translators. AutoCAD includes extensive export and import translators at no extra cost through an online service.

BricsCAD Communicator works with all editions of BricsCAD, except Standard. When Communicator is installed on your computer, the added file formats appear automatically in the droplists of the Import and Export dialog boxes.

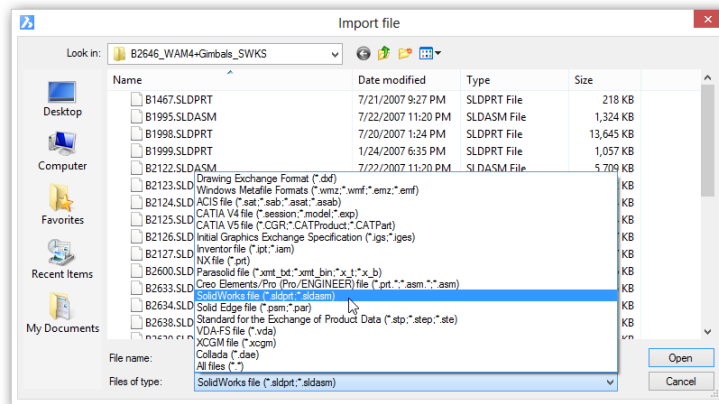

The file types available through the Import dialog box

Import Formats Supported

Standard Formats	AutoCAD	BricsCAD	Description
igs, iges	•	•	Initial Graphics Exchange Specification
jt	•		Siemens Jupiter Technology
x_t, xmt_txt, x_b, xmt_bin	•	•	Siemens Parasolid
ste, stp, step	•	•	Standard for Exchange of Product data
vda		•	VDA-FS
xcgm		•	XML-based CGM
Proprietary Formats			
model, catpart, catproduct	•	•	CATIA V4 and V5 (Windows only)
asm, prt	•	•	Creo Elements / Pro Engineer
iam, ipt	•	•	Inventor
prt	•	•	NX
3dm	•		Rhino
par, psm		•	Solid Edge
sldasm, sldprt	•	•	Solidworks

Export Formats Supported

Standard Formats	AutoCAD	BricsCAD	Description
igs, iges	•	•	Initial Graphics Exchange Specification
ste, stp, step		•	Standard for Exchange of Product data
stl	•	•	Stereolithography
vda		•	VDA-FS
Proprietary Formats			
eps	•		Adobe Encapsulated PostScript
pdf	•	•	Adobe 3D PDF (Windows only)
model, catpart, catproduct		•	CATIA V4 and V5 (Windows only)

When assembly file files are imported, the **ImportProductStructure** variable determines if models are imported as plain geometry or mapped to product structure as native blocks or mechanical components.

Importing & Exporting Without Communicator

BricsCAD includes 3D import and export translators that are free, independent of Communicator.

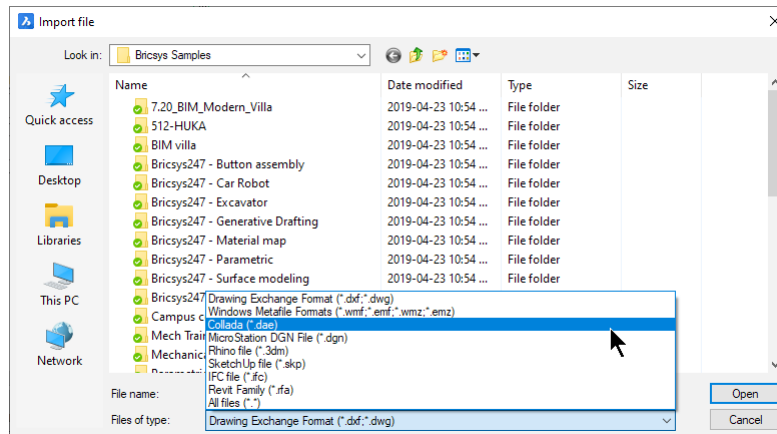

Export formats available without Communicator

The 3D file formats supported are as follows:

Import Formats	Description
dae	Collada (COLLABorative Design Activity)
dgn	Microstation design file
dwg	AutoCAD drawing file compatible with 2013-2019
dxf	AutoCAD drawing interchange format
ifc	Industry foundation classes for BIM
rfa	Revit families
skp	SketchUp

Export Formats	Description
dae	Collada (COLLABorative Design Activity)
dwg	AutoCAD drawing file compatible with 2013-2017
dxf	AutoCAD drawing interchange format
dwf	Autodesk 2D and 3D DWF v6.01
fbx	Autodesk Filmbox format
ifc	Industry foundation classes for BIM
stl	Stereolithography used for 3D printing

Use the SaveAs command to save to AutoCAD formats older than 2013 — all the way back to Release 14 for DWG and Release 9 for DXF.

Accessing Import and Export Commands

- › Enter the **Import** or **Export** command
 - › From the **File** menu, choose **Import** or **Export**
-

As this chapter illustrates, BricsCAD is in many areas of 3D design more capable than AutoCAD.

AutoCAD-BricsCAD Command Cross-reference

THIS APPENDIX LISTS THE NAMES OF COMMANDS FOUND IN BRICSCAD V20 AND AUTOCAD 2020. The list is sorted alphabetically by command name for both CAD packages. When there are no exact matches, notes suggest equivalent commands. Command names added since the previous edition of this ebook are shown in **blue**.

The following command sets are segregated from the main listing, as AutoCAD does not offer these functions:

- **bim-** Building information modeling (BIM) commands
- **Civil** Civil engineering commands (**new in V20**)
- **bm-** BricsCAD mechanical commands
- **dm-** Direct modeling and 3D constraints commands
- **sm-** Sheet metal commands

This appendix includes command names removed from recent releases of BricsCAD, along with their replacements, if any.

Commands specific to working with dynamic blocks in AutoCAD's Block Editor environment are not listed, as BricsCAD does not support them. Commands undocumented by Autodesk are not included, nor are its Express Tools commands.

AutoCAD Command	BricsCAD Command	Notes
A Commands		
About	About	
AcisIn	AcisIn	
AcisOut	AcisOut	
ActBasepoint	...	
ActManager	...	
ActMDragAction	...	
ActRecord	...	In BricsCAD, use RecScript
ActStop, -ActStop	...	In BricsCAD, use RecScript
ActUserInput	...	
ActUserMessage, -ActUserMessage	...	
AdCenter, AdcClose	...	In BricsCAD, use Explorer
AdcNavigate	...	
...	AddInMan	VBA COM Add-In Manager for BricsCAD
AddSelected	AddSelected	
Adjust	...	In BricsCAD, use ImageAdjust
Ai_Box	Ai_Box	
Ai_Cone	Ai_Cone	
Ai_Cylinder	Ai_Cylinder	
Ai_Dish	Ai_Dish	
Ai_Dome	Ai_Dome	
...	Ai_EdgeSurf	In AutoCAD, use EdgeSurf
Ai_Mesh	...	In BricsCAD, use Mesh
Ai_Pyramid	Ai_Pyramid	
...	Ai_RevSurf	In AutoCAD, use RevSurf
...	Ai_RuleSurf	In AutoCAD, use RuleSurf
Ai_Sphere	Ai_Sphere	
...	Ai_TabSurf	In AutoCAD, use TabSurf
Ai_Torus	Ai_Torus	
Ai_Wedge	Ai_Wedge	
AiDimFlipArrow	AiDimFlipArrow	
AiDimPrec	AiDimPrec	
AiDimTextMove	...	
AiDimStyle	AiDimStyle	
AiMleaderEditAdd	AiMleaderEditAdd	
AiMleaderEditRemove	AiMleaderEditRemove	
AiObjectScaleAdd	...	
AiObjectScaleRemove	...	
Align	Align	
...	AlignSpace	In BricsCAD, aligns viewports
AllPlay	...	
AmeConvert	...	
AnalysisCurvature	...	
AnalysisDraft	...	
AnalysisOptions	...	
AnalysisZebra	...	
AniPath	AniPath	
AnnoReset	AnnoReset	

AutoCAD Command	BricsCAD Command	Notes
AnnoUpdate	AnnoUpdate	
Aperture	Aperture	
...	Apparent	In AutoCAD, use -Osnap Apparent
AppAutoLoader	...	
AppLoad	AppLoad	
AppStore	...	
Arc	Arc	
Archive	...	
Area	Area	
Array, -Array	Array, -Array	In BricsCAD, now supports dynamic, editable arrays
ArrayClassic	ArrayClassic	
ArrayClose	ArrayClose, -ArrayClose	
ArrayEdit	ArrayEdit	
...	ArrayEditExt	In BricsCAD, edits entities in arrays.
ArrayPath	ArrayPath	
ArrayPolar	ArrayPolar	
ArrayRect	ArrayRect	
Arx	...	In BricsCAD, use AppLoad
Attach	...	In BricsCAD, use ImageAttach, Xref, PdfAdjust
...	AttachmentsPanelOpen/Close	In AutoCAD, use ExternalReferences command
AttachURL	...	In BricsCAD, use Hyperlink
AttDef, -AttDef	AttDef, -AttDef	
AttDisp	AttDisp	
AttEdit, -AttEdit	AttEdit	
AttExt, -AttExt	AttExt, -AttExt	
AttLPedit	...	
AttRedef	AttRedef	
AttSync	AttSync	
Audit	Audit	
...	AutoComplete	
AutoConstrain	...	In BricsCAD, use the GcCoincident command's AutoConstrain option
AutoPublish	...	

B Commands

Background	Background	
Base	Base	
BAttMan	BAttMan	
BAttOrder	...	
BEdit, BClose	BEdit, -BEdit, BClose	Dynamic blocks can be used in BricsCAD, but not created or edited
BESettings	...	
BHatch, -BHatch	BHatch, -BHatch	Starts the boundary hatch command
...	Blade	In AutoCAD, use the VLIDE command
...	BlCompositions	Displays the Compositions dialog box
...	<i>bim-</i>	For BIM commands, see later in this appendix
Blend	...	
...	BIMaterials	Displays the Physical Material dialog box
...	<i>bm-</i>	For mechanical commands, see later in this appendix
Block, -Block	Block, -Block	

AutoCAD Command	BricsCAD Command	Notes
BlocksPalette / Close	...	In BriscCAD, use ExpBlocks
BlockIcon	...	Required by AutoCAD for old drawings
...	Blockify	Converts entities into blocks
BmpOut	BmpOut	
Boundary, -Boundary	Boundary, -Boundary	
Box	Box	
Break	Break	
BRep	...	
Browser	Browser	

C Commands

Cal	Cal	BricsCAD displays Windows Calculator
Camera	Camera	
...	Center	In AutoCAD, use -Osnap Center
CenterDisassociate	CenterDisassociate	
Centerline	Centerline	
Centermark	Centermark	
CenterReassociate	CenterReassociate	
CenterReset	CenterReset	
Chamfer	Chamfer	
ChamferEdge	...	In BricsCAD, use dmChamfer
Change	Change	
CheckStandards	...	
ChProp	ChProp	
ChSpace	ChSpace	
Circle	Circle	
...	Chapoo-	Chapoo commands are renamed with "cloud-" in V18
ClassicGroup	...	In BricsCAD, use Group
ClassicImage	...	In BricsCAD, use Image
ClassicLayer	...	In BricsCAD, use Layer
ClassicXref	...	In BricsCAD, use Xref
CleanScreenOn / Off	CleanScreenOn / Off	
...	CleanUnusedVariables	For developer use in BricsCAD
Clip	...	In BricsCAD, use XClip
...	ClipDisplay	Changes the clipping of sections
Close	Close	
CloseAll	CloseAll	
CloseAllOther	...	In BricsCAD, right-click tab for this option
CloseAllWithoutSaving	...	
CloseAllWithSaving	...	
...	CloudAccount	Log onto 24/7 account
...	CloudDownload	Downloads files from 24/7 storage
...	CloudLogOff	Logs off your 24/7 account
...	CloudLogOn	Logs into your 24/7 account
...	CloudOpen	Opens a drawing from 24/7 storage
...	CloudProject	Opens 24/7 online account in default browser
...	CloudUpload	Saves the current drawing to 24/7 storage
...	CloudWeb	Removed from V19
Color, -Color	Color, -Color	

AutoCAD Command	BricsCAD Command	Notes
CommandLine / Hide	CommandLine / Hide	
...	Commands	In AutoCAD, use the ARX command
...	CommunicatorInfo	Checks status of Communicator module
Compare, -Compare	DwgCompare	
CompareClose	...	
CompareColor	...	In BricsCAD, use Cmp... variables
CompareCopyInfo	...	In BricsCAD, use Cmp... variables
CompareDiffNext	...	In BricsCAD, use Cmp... variables
CompareDiffPrev	...	In BricsCAD, use Cmp... variables
CompareDiffZoomTo	...	In BricsCAD, use Cmp... variables
CompareDisplayOrder	...	In BricsCAD, use Cmp... variables
CompareExport	...	
CompareExportWorker	...	
CompareImport	...	
CompareInfo	...	In BricsCAD, use Cmp... variables
CompareInsertInfo	...	In BricsCAD, use Cmp... variables
CompareToggleReference	...	
CompareWorker	...	In BricsCAD, use Cmp... variables
Compile	...	Required by AutoCAD only for converting PostScript font files
...	ComponentsPanelOpen/Close	Toggles the display of the Components panel
Cone	Cone	
ConstraintBar	ConstraintBar	
ConstraintSettings	...	In BricsCAD, use Settings
...	ContentBrowserClose / Open	Closes and opens the Content Browser panel
Continue	...	In BricsCAD, use the Dim command
Convert	...	Required by AutoCAD only for old drawings
ConvertCTB	ConvertCTB	
ConvertOldLights	ConvertOldLights	Required for old drawings only
ConvertOldMaterials	ConvertOldMaterials	Required for old drawings only
ConvertPoly	ConvertPoly	
ConvertPStyles	ConvertPStyles	
ConvToMesh	ConvToMesh	
ConvToNurbs	...	
ConvToSolid	ConvToSolid	
ConvToSurface	ConvToSurface	
CoordinationModelAttach	...	
Copy	Copy	
CopyBase	CopyBase	
CopyClip	CopyClip	
...	CopyEData	In BricsCAD, copies xdata between entities
...	CopyGuided	Copies entities along guide lines
CopyHist	CopyHist	
CopyLink	...	
CopyToLayer	CopyToLayer	
...	CPageSetup	In AutoCAD, user PageSetup
CUI	CUI	Executes BricsCAD's Customize command
CuiExport, CuiImport	...	In BricsCAD, use File menu in Customize dialog box
CuiLoad, CuiUnload	CuiLoad, CuiUnload	
CurrentEntityLog	...	

AutoCAD Command	BricsCAD Command	Notes
Customize, +Customize	Customize	In AutoCAD, use CUI
CutClip	CutClip	
CvAdd, CvRemove	...	
CvHide, CvShow	...	
CvRebuild, -CvRebuild	...	
Cylinder	Cylinder	
D Commands		
DataExtraction	DataExtraction	
DataLink	DataLink	
DataLinkUpdate	DataLinkUpdate	
DbConfigure	...	
DbConnect, DbClose	...	
DbList	DbList	dc = dimensional constraint
DcAligned	dcAligned	
DcAngular	dcAngular	
DcConvert	dcConvert	
DcDiameter	dcDiameter	
DcDisplay	dcDisplay	
DcForm	...	
DcHorizontal	dcHorizontal	
DcLinear	dcLinear	
DcRadius	dcRadius	
DcVertical	dcVertical	
...	DdAttE	In AutoCAD, use AttEdit
...	DdEdit	Renamed EditText in AutoCAD 2010
...	DdEModes	BricsCAD uses Settings dialog for entity creation
...	DdFilter	BricsCAD uses DdFilter selection menu
...	DdGrips	BricsCAD uses Settings dialog for grips
...	DdPtype	BricsCAD uses Settings dialog for points
...	DdSelect	BricsCAD uses Settings dialog for entity selection
...	DdSetVar	BricsCAD uses Settings dialog box
...	DdSTrack	BricsCAD uses Settings dialog for snap tracking
DdVPoint	DdVPoint	
...	DefaultScaleList	In AutoCAD, use ScaleListEdit
Delay	Delay	
DelConstraint	DelConstraint	
...	DelEData	In BricsCAD, erases xdata from entities
...	DesignTable	Creates new design tables for the Mechanical Browser
...	-DesignTableEdit	Configures, replaces, exports, and deletes design tables at the command line
DesktopAnalytics	...	
DetachURL	...	In BricsCAD, use Hyperlink
DgnAdjust	...	
DgnAttach	...	
DgnClip	...	
DgnExport	...	BricsCAD does not export DGN files
DgnImport	DgnImport	
...	DgnImportOptions	Opens Settings dialog box at DgnImport section
DgnLayers	...	Use Dgn... settings

AutoCAD Command	BricsCAD Command	Notes
DgnMapping	...	Use Dgn... settings
DigitalSign	...	
DimConstraint	DimConstraint	
...	Dish	In BricsCAD, draws 3D solid dishes
Dist	Dist	
DistantLight	DistantLight	
Divide	Divide	
...	dm-	For direct modeling commands, see the last part of this appendix
...	Dome	In BricsCAD, draws 3D solid domes
Donut	Donut	
DownloadManager	...	
...	Drag	Moves faces
Dragmode	Dragmode	
DrawingRecovery / Hide	...	In BricsCAD, use Recover
DrawOrder	DrawOrder	
...	DrawOrderByLayer	In BricsCAD, controls draw order through layer names
DSettings	DSettings	
...	DstConvert	Converts sheetset DST files to XML format.
...	DText	In AutoCAD, use Text
...	DumpState	For use by BricsCAD developers
DView	DView	
DwfAdjust	...	BricsCAD does not import DWF files
DwfAttach	...	
DwfClip	...	
DwfFormat	...	
DwfLayers	...	
...	DwgCodePage	In AutoCAD, use DwgCodePage system variable
...	DwgCompare	Compares differences between two drawings
DwgConvert	...	In BricsCAD, use the SaveAs command
DwgProps	DwgProps	
Dxbin	...	Required only for CAD\camera support, now obsolete
...	Dxfln	Opens DXF files
...	DxfOut	Exports drawings in DXF format

Dimension Commands

Dim	Dim	
...	Dim1	
DimAligned	DimAligned	
DimAngular	DimAngular	
DimArc	DimArc	
DimBaseline	DimBaseline	
DimBreak	DimBreak	
DimCenter	DimCenter	
DimContinue	DimContinue	
DimDiameter	DimDiameter	
DimDisassociate	DimDisassociate	
DimEdit	DimEdit	
DimInspect, -DimInspect	...	
DimJogged	...	

AutoCAD Command	BricsCAD Command	Notes
DimJogLine	...	
...	DimLeader	In AutoCAD, use Leader
DimLinear	DimLinear	
DimProperties	...	
DimOrdinate	DimOrdinate	
DimOverride	DimOverride	
DimRadius	DimRadius	
DimReassociate	DimReassociate	
DimRegen	DimRegen	
DimRotated	DimRotated	
DimSpace	...	
DimStyle, DimStyle	DimStyle, -DimStyle	
...	DimStyleSet	Sets the working dimension style
DimTEdit	DimTEdit	

E Commands

EAttEdit	EAttEdit	
EAttExt	...	In BricsCAD, use the DataExtraction command
Edge	...	
EdgeSurf	EdgeSurf	
...	EditEData	In BricsCAD, edits xdata
EditShot	...	
Elev	Elev	
Ellipse	Ellipse	
...	EndCompare	Ends the drawing compare session
...	Endpoint	In AutoCAD, use -Osnap Endpoint
Erase	Erase	
eTransmit	eTransmit	
...	ExecuteTool	For use by BricsCAD developers
...	ExpBlocks	In AutoCAD, use the AdCenter command
...	ExpFolders	In AutoCAD, use the AdCenter command
...	ExpImages	Opens Drawing Explorer at the Images section.
...	ExpLayers	Opens Drawing Explorer at the Layers section.
...	ExpPdfs	Opens Drawing Explorer at the PDF section.
...	ExpXrefs	Opens Drawing Explorer at the XRefs section.
Explode	Explode	
...	Explorer	In AutoCAD, use the AdCenter command
Export, -Export	Export	
ExportDWF	...	In BricsCAD, use the DwfOut command
ExportDWFx	...	In BricsCAD, use the Export command
ExportLayout	ExportLayout	
ExportPDF	ExportPDF	
ExportSettings	...	
-ExportToAutocad	...	
...	ExpUcs	
Extend	Extend	
...	Extension	In AutoCAD, use -OSnap Extension
ExternalReferences / Close	...	In BricsCAD, use the Xref command
Extrude	Extrude	

AutoCAD Command	BricsCAD Command	Notes
F Commands		
...	FbxExport, -FbxExport	AutoCAD does not export in FBX format as of 2019
Field	Field	
FileOpen	FileOpen	Opens files at the command prompt
Files	Files	Displays Windows' File Explorer
FilesTab, FileTabClose	...	In BricsCAD, drawing tabs are always open
Fill	Fill	
Fillet	Fillet	
FilletEdge	...	In BricsCAD, use the DmFillet command
Filter	...	In BricsCAD, use the DdFilter command
Filters	...	
Find	Find	
FlatShot	FlatShot	
Flatten	Flatten	In BricsCAD, flattens 3D objects with thickness
Freespot	...	In BricsCAD, use the SpotLight command
Freeweb	...	In BricsCAD, use the WebLight command
G Commands		
<i>(gc = geometric constraints)</i>		
GcCoincident	GcCoincident	
GcCollinear	GcCollinear	
GcConcentric	GcConcentric	
...	GCenter	Snaps to the centroid of closed entities
GcEqual	GcEqual	
GcFix	GcFix	
...	GcHorizontal	
GcParallel	GcParallel	
GcPerpendicular	GcPerpendicular	
GcSmooth	GcSmooth	
GcSymmetric	GcSymmetric	
GcTangent	GcTangent	
GcVertical	GcVertical	
...	GenerateBoundary	Creates closed polylines from faces of 3D solids
GeographicLocation	GeographicLocation	
GeoLocateMe	...	
GeoMap	...	BricsCAD imports GeoTiff files
GeoMapImage	...	In BricsCAD, use the MapConnect command
GeoMapImageUpdate	...	In BricsCAD, use the MapConnect command
GeoMarkLatLong	...	
GeoMarkMe	...	
GeoMarkPoint	...	
GeoMarkPosition	...	
GeomConstraint	GeomConstraint	
GeoRemove	...	In BricsCAD, use the MapConnect command
GeoReorientMarker	...	
GetUrl	...	In BricsCAD, use the Hyperlink command
GotoStart	GotoStart	
Gradient	Gradient and -Gradient	

AutoCAD Command	BricsCAD Command	Notes
...	GradientBkgOff / On	Turns background gradient off and on
...	Grading	Adjusts the surfaces of imported TIN files
GraphicsConfig, -GraphicsConfig	...	In BricsCAD, use the RedSdkInfo command
GraphScr	GraphScr	
Grid	Grid	
Group, -Group	Group, -Group	
GroupEdit	...	

H Commands

Hatch, -Hatch	Hatch, -Hatch	
HatchEdit, HatchEdit	HatchEdit, HatchEdit	
HatchGenerateBoundary	HatchGenerateBoundary	
...	HatchGripEdit	Adds and removes grips from hatches and gradients.
HatchSetBoundary	...	
HatchSetOrigin	...	
HatchToBack	HatchToBack	
Helix	Helix	
Help, ?	Help, ?	
...	HelpSearch	Searches for help topics on the command line
Hide	Hide	In AutoCAD, used for wireframe mode only
HideObjects	HideObjects	
HidePalettes	...	
HighlightNew	...	
HLSettings	...	
HomeText	...	In BricsCAD, use the Dim command
Horizontal	...	In BricsCAD, use the Dim command
Hyperlink, -Hyperlink	Hyperlink, -Hyperlink	
HyperlinkOptions	HyperlinkOptions	

I Commands

Id	Id	
IgesImport / Export	...	In BricsCAD, use the optional Communicator add-on
-Image	Image	
ImageAdjust	ImageAdjust	
ImageAttach	ImageAttach, -ImageAttach	
ImageClip	ImageClip	
...	ImageFrame	In AutoCAD, use the ImageFrame system variable
ImageQuality	ImageQuality	
Import	Import	
Imprint	Imprint	
InputSearchOptions	...	
Insert, -Insert	Insert, -Insert	
...	InsertAligned	Inserts multiple and mirrored blocks
...	InsertGuided and -InsertGuided	Inserts blocks along guide curves
...	Insertion	In AutoCAD, use -OSnap Insertion
InsertObj	InsertObj	
Interfere	Interfere	
Intersect	Intersect	

AutoCAD Command	BricsCAD Command	Notes
...	Intersection	In AutoCAD, use -OSnap Intersection
...	InvokeTestApp	Runs BCadTestModuleClient, if loaded
IsoDraft	...	
IsolateObjects	IsolateObjects	Hides all entities, except the selected ones
Isoplane	Isoplane	

J Commands

Join	Join	
JpgOut	...	
JustifyText	...	

K Command

...	KeepMe	Visually merges drawings during the DrawingCompare command
-----	--------	--

L Commands

LayCur	LayCur	
LayDel	...	In BricsCAD, use Layer command
Layer, -Layer, +Layer	Layer, -Layer	BricsCAD uses Explorer for layers
LayerPalette, LayerClose	LayersPanelClose / Open	Closes and opens the Layers panel.
LayerP	LayerP	
LayerPMode	...	In BricsCAD, use LayerPMode system variable
LayerState	LayerState	BricsCAD uses Explorer for layer states
LayerStateSave	...	
LayFrz	LayFrz	
LayIso	LayIso	
LayLck	LayLck	
LayMch	...	
LayMCur	LayMCur	
LayMrg	...	
LayOff, LayOn	LayOff, LayOn	
Layout, -Layout	Layout	
...	LayoutManager	Displays Layout Manager for creating, naming, and reordering sets of layouts
LayoutWizard	...	To be supported in a future release of BricsCAD
LayThw	LayThw	
LayTrans	...	
LayULk	LayULk	
LayUnIso	LayUnIso	
LayVpi	...	In BricsCAD, use the Layer command
LayWalk	...	
...	LConnect	Connects faces of two solids
Leader	Leader	
Lengthen	Lengthen	
...	LicenseManager	In AutoCAD, click Help About Product Information
...	LicEnterKey	Enters BricsCAD license key
...	LicProperties	Displays license information
...	LicPropertiesBim	License state of the BIM module
...	LicPropertiesCommunicator	Licence state of the Communicator module
...	LicPropertiesSheetmetal	Licence state of the sheet metal module

AutoCAD Command	BricsCAD Command	Notes
Light	Light	
LightList, LightListClose	LightList	BricsCAD uses Explorer for lights
Limits	Limits	
Line	Line	
Linetype, -Linetype	Linetype, -Linetype	BricsCAD uses Explorer for linetypes
List	List	
LiveSection	LiveSection	
Load	Load	
Loft	Loft	
LogFileOn, LogFileOff	LogFileOn, LogFileOff	
...	LookFrom	In AutoCAD, use the NavCube command
LtScale	LtScale	
LWeight, -LWeight	LWeight	BricsCAD uses Settings for lineweights

M Commands

...	Mail	Attaches current drawing to new email message
MakePreview	...	
...	Manipulate	Widget for rotating, moving, mirroring, and scaling entities
...	MapConnect	In AutoCAD, use the GeoMapImage command
Markup, MarkupClose	...	BricsCAD does not support markup files
MassProp	MassProp	
MatBrowserClose / Open	MatBrowserClose / Open	
MatchCell	...	
...	MatchPerspective	Changes the viewpoint in perspective mode to match a background image
MatchProp	MatchProp	
MatEditorOpen / Close	Materials	In BricsCAD, use Explorer to edit materials
MaterialAssign	MaterialAssign	
MaterialAttach	...	In BricsCAD, use Layer and Properties to assign materials
MaterialMap	MaterialMap	
Materials / Close	Materials	
...	MatLib	Displays the Rendering Materials panel
Measure	Measure	
MeasureGeom	...	In BricsCAD, use the Area, Dist, and MassProp commands
...	MechanicalBrowserClose	Closes the Mechanical Browser panel
...	MechanicalBrowserOpen	Displays the Mechanical Browser panel
Menu	Menu	
...	MenuLoad, MenuUnload	In AutoCAD, use CuiLoad and CuiUnload
Mesh	Mesh	
MeshCap	...	BricsCAD does not support point-defined surface meshes
MeshCollapse	...	
MeshCrease	...	
MeshExtrude	...	
MeshMerge	...	
MeshOptions	...	
MeshPrimitiveOptions	...	
MeshRefine	...	
MeshSmooth	...	
MeshSmoothLess / More	...	
MeshSpin	...	

AutoCAD Command	BricsCAD Command	Notes
MeshSplit	...	
MeshUncrease	...	
...	Midpoint	In AutoCAD, use -OSnap Midpoint
MigrateMaterials	...	Required only for old AutoCAD drawings
MInsert	MInsert	
Mirror	Mirror	
Mirror3d	Mirror3d	
MLeader	MLeader	
MLeaderAlign	MLeaderAlign	
MLeaderCollect	MLeaderCollect	
MLeaderEdit	MLeaderEdit	
...	MLeaderEditText	Edits all aspects of mleaders
MLeaderStyle	MLeaderStyle	
MIEdit, -MIEdit	...	In BricsCAD, use Properties
MLine	MLine	
MStyle	MLineStyle	BricsCAD uses Explorer for multiline styles
Model	...	In BricsCAD, double-click inside the viewport
...	ModelProperties	Opens Settings dialog at Modeler section
...	-ModelProperties	Specifies 3D modeling tolerances at the command prompt
Move	Move	
...	MoveEData	Moves xdata between entities
MRedo	...	In BricsCAD, use Redo multiple times
MSlide	MSlide	
MSpace	MSpace	
MtEdit	...	In BricsCAD, use Properties
MText	MText, -MText	
Multiple	Multiple	
MView	MView	
MvSetup	MvSetup	

N Commands

NavBar	...	
...	Navigate	In AutoCAD, use 3dWalk / 3dFly
NavSMotion / Close	...	
NavSWheel	...	
NavVCube	...	In BricsCAD, use the LookFrom command
NCopy	...	
...	Nearest	In AutoCAD, use -Osnap Nearest
NetLoad	NetLoad	
New	New	
NewSheetset	NewSheetset	
NewShot	...	
NewView	...	
...	NewWiz	In BricsCAD, begins new drawings with wizard
...	Node	In AutoCAD, use -OSnap Node
...	None	In AutoCAD, use -OSnap None
Nudge	...	In BricsCAD, use Ctrl+cursor keys
...	Number	Numbers entities

AutoCAD Command	BricsCAD Command	Notes
O Commands		
ObjectScale	ObjectScale, -ObjectScale	
Offset	Offset	
OffsetEdge	...	In BricsCAD, use the SolidEdit Offset command
OleLinks	OleLinks	
OleOpen	OleOpen	
OleScale	...	
OnlineDesignShare	...	In BricsCAD, use CloudAccount
...	OnWeb	Opens Bricsys.com home page; in AutoCAD, use Browser
Oops	Oops	
Open	Open	
OpenDwfMarkup	...	BricsCAD does not support DWG and markup files
OpenFromWebMobile	...	
OpenSheetsset	OpenSheetsset, -OpenSheetsset	
Options, + Options	Options	
Ordinate	...	In BricsCAD, use the Dim command
Ortho	Orthogonal	
OSnap, -OSnap	OSnap, -OSnap	
OverKill	OverKill, -OverKill	
Override	...	In BricsCAD, use the Dim command
P Commands		
PageSetup	PageSetup	
Pan, -Pan	Pan, -Pan	
...	Panelize	In BricsCAD, makes rectangular grid on surfaces
...	Parallel	In AutoCAD, use -OSnap Parallel
Parameters, ParametersClose	ParametersPanelOpen/Close	
...	Parameterize	In BricsCAD, constrains entities automatically
...	-Parameters	Creates and edits parameters at the command line
...	ParametricBlock	Creates parametric blocks from entities in the drawing
PartialLoad	...	
-PartialOpen	...	
PasteAsHyperlink	...	
PasteBlock	PasteBlock	
PasteClip	PasteClip	
PasteOrig	PasteOrig	
PasteSpec	PasteSpec	
PcExtractCenterLine	...	
PcExtractCorner	...	
PcExtractEdge	...	
PcExtractSection	...	
PcInWizard	...	
...	PDF	In AutoCAD, use ExternalReferences command
PdfAdjust	PdfAdjust	
PdfAttach	PdfAttach, -PdfAttach	
PdfClip	PdfClip	
...	PdfImport , -PdfImport	Import PDF files and converts them to drawing entities
PdfLayers	PdfLayers	

AutoCAD Command	BricsCAD Command	Notes
...	PdfOptions	Settings for PDF exports
PdfShxTxT	...	
PEdit	PEdit	
...	PEditExt	Edits polylines at the command line
...	Perpendicular	In AutoCAD, use -OSnap Perpendicular
PFace	PFace	
...	Placeview	Places model views into layouts
Plan	Plan	
PlaneSurf	...	
PLine	PLine	
Plot, -Plot	Plot, -Plot	
PlotStamp	...	In BricsCAD, use Print command's Plot Stamp option
PlotStyle, -PlotStyle	PlotStyle	
PlotterManager	PlotterManager	
PmToggle	...	
PngOut	...	
Point	Point	
...	PointCloud	Opens the Drawing Explorer at the Point Clouds section
PointCloudAttach	PointCloudAttach, -PointCloudAttach	
PointCloudColorMap	PointCloudColorMap	
PointCloudCrop / Uncrop	PointCloudCrop / Uncrop	
PointCloudCropState	...	
PointCloudManager / Close	...	
PointCloudStylize	...	
...	PointCloudPointSize	Specifies the size of points in the cloud
...	PointCloudPointSize_Minus	Decreases the point size
...	PointCloudPointSize_Plus	Increases the point size
...	PointCloudPreprocess	Converts point cloud files to BPT/ VRM (virtual reality model) file format,
...	-PointCloudPreprocess	Command-line version of the PointCloudPreprocess dialog box
PointLight	PointLight	
Polygon	Polygon	
PolySolid	PolySolid	
PressPull	...	In BricsCAD, use the dmPushpull command
Preview	Preview	
...	Print	In BricsCAD, operates like AutoCAD's Plot command
ProjectGeometry	ProjectGeometry	
...	ProfileManager	In AutoCAD, use Profiles tab of Options command
Properties, PropertiesClose	Properties, PropertiesClose	
...	Proxyinfo	Displays the Proxy Information dialog box
PSetupIn, -PSetupIn	PSetupIn, -PSetupIn	
PSpace	PSpace	
PType	...	In BricsCAD, use the DdPtype command
Publish, -Publish, +Publish	Publish, -Publish	
Purge	Purge, -Purge	
Pyramid	Pyramid	

AutoCAD Command	BricsCAD Command	Notes
Q Commands		
QDim	...	QDim removed from BricsCAD V14.1.02
QLeader	QLeader	
QNew	QNew	
...	QPrint	In BricsCAD, plots directly without dialog box
QSave	QSave	
QSelect	QSelect	
QText	QText	
QuickCalc, QcClose	...	In BricsCAD, use the Calc command
...	Quadrant	In AutoCAD, use -OSnap Quadrant
QuickCui	...	In BricsCAD, use the Customize command
QuickProperties	...	
Quit	Quit	
QvDrawing, QvDrawingClose	...	In BricsCAD, use Window menu
QvLayout, QvLayoutClose	...	In BricsCAD, use layout tabs or drawing tabs
R Commands		
Ray	Ray	
...	ReassocApp	In BricsCAD, reassociates apps with xdata
Recap	...	BricsCAD does not support point clouds
...	RecordRawInput	For developer use in BricsCAD
Recover, RecoverAll	Recover, RecoverAll	
...	RecScript	In BricsCAD, begins recording a script file
Rectang	Rectang	
Redefine	Redefine	
Redo	Redo	
Redraw, RedrawAll	Redraw, RedrawAll	
...	RedSdkInfo	In AutoCAD, use GraphicsConfig
RefClose	RefClose	
RefEdit	RefEdit, -RefEdit	
RefSet	RefSet	
Regen, RegenAll	Regen, RegenAll	
Regen3	...	
RegenAuto	RegenAuto	
Region	Region	
Reinit	Reinit	
Rename	Rename, -Rename	BricsCAD uses Explorer to rename styles
Render, -Render	Render, -Render	
RenderCrop	...	
RenderEnvironment / Close	...	To be supported in a future release of BricsCAD
RenderExposure / Close	...	
RenderOnline	...	
RenderPresets / Close	RenderPresets	BricsCAD uses Explorer to set rendering presets
RenderWindow / Close	...	
...	RenderWinClose	
...	ReportPanelClose	Closes the Report panel
...	ReportPanelOpen	Opens the Report panel
...	ResetAssocViews	Resets associated views of selected entities

AutoCAD Command	BricsCAD Command	Notes
ResetBlock	ResetBlock	
Resume	Resume	
RevCloud	RevCloud	
Reverse	...	
Revolve	Revolve	
RevSurf	RevSurf	
Ribbon, RibbonClose	Ribbon, RibbonClose	
RibbonVPorts	...	
Rotate	Rotate	
Rotate3D	Rotate3D	
RPref, RPrefClose	...	To be supported in a future release of BricsCAD
RScript	RScript	
...	RtLook	In AutoCAD, use 3dFly; Rt = realtime
...	RtPan	In AutoCAD, use 3dPan
...	RtRot	In AutoCAD, use 3dOrbit
...	RtRotCtr	In AutoCAD, use 3dOrbit
...	RtRotF	In AutoCAD, use 3dOrbit
...	RtRotX	In AutoCAD, use 3dOrbit
...	RtRotY	In AutoCAD, use 3dOrbit
...	RtRotZ	In AutoCAD, use 3dOrbit
...	RtUpDown	In AutoCAD, use 3dSwivel
...	RtWalk	In AutoCAD, use 3dWalk
...	RtZoom	In AutoCAD, use 3dZoom
RuleSurf	RuleSurf	
...	RunAsLevel	Changes the version of BricsCAD, such as to Classic or Pro

S Commands

Save, SaveAll	Save, SaveAll	
SaveAs, + SaveAs	SaveAs	
...	SaveAsR12	Saves drawings in R12 DWG format
SaveImg	...	To be supported in a future release of BricsCAD; for now use Export or MSlide
...	SaveFileFolder	Opens File Explorer to the current folder used to save drawings
SaveToWebMobile	...	
Scale	Scale	
ScaleListEdit	ScaleListEdit, -ScaleListEdit	
ScaleText	...	
...	Screenshot	Saves current space, excluding all UI elements, as a raster file
Script	Script	
ScriptCall	...	
...	Scrollbar	Toggles scroll bars
Section	Section	
SectionPlane	SectionPlane	
SectionPlaneJog	...	
SectionPlaneSettings	SectionPlaneSettings	In BricsCAD, use Explorer for section plane settings
SectionPlaneToBlock	SectionPlaneToBlock	
SectionSpinners	
...	Security	Determines whether VBA macros may run
SecurityOptions	SecurityOptions	
Select	Select	

AutoCAD Command	BricsCAD Command	Notes
...	SelectAlignedFaces	Selects all faces coplanar with the selected face
...	SelectAlignedSolids	Selects all solids with faces coplanar to the selected face
...	SelectConnectedFaces	Selects all faces connected to the selected face
...	SelectConnectedSolids	Selects all solids whose faces are connected to the selected face
SelectSimilar	SelectSimilar	
...	SelGrips	In AutoCAD, use Ai_SelAll
SetByLayer	...	
...	Settings	In BricsCAD, displays Settings dialog box
...	SettingsSearch	In BricsCAD, searches Settings dialog from the command line
...	SetUCS	In AutoCAD, use UcsMan
SelectURL	...	
SequencePlay	...	
SetVar	SetVar	
...	Shade	In AutoCAD, use VsCurrent
ShadeMode, -ShadeMode	ShadeMode, -ShadeMode	
Shape	Shape	
Sheetset, SheetsetHide	Sheetset, SheetsetHide	Renamed from SheetsetClose in V18
Shell, Sh	Shell, Sh	
ShowPalettes	...	
ShowRenderGallery	...	
SigValidate	...	
...	Singleton	In AutoCAD, use SDI system variable
...	Site	Imports TIM files into the current drawing
...	SiteEdit	Edits the TIM surface
Sketch	Sketch	
Slice	Slice	
...	sm-	For sheet metal commands, see the end of this appendix
Snap	Snap	
SolDraw	...	In BricsCAD, use the ViewBase command
Solid	Solid	
SolidEdit	SolidEdit	
SolProf	SolProf	
SolView	...	In BricsCAD, use the ViewBase command
SpaceTrans	...	
Spell	Spell	
Sphere	Sphere	
Spline	Spline	
SplinEdit	SplinEdit	
SpotLight	SpotLight	
Standards	...	
...	StandardPartsPanelClose	Closes the Standard Parts panel.
...	StandardPartsPanelOpen	Opens Standard Parts panel to insert hardware parts as mechanical components
...	StatBar	In AutoCAD, use StatBar system variable
Status	Status	
StlOut	StlOut	
...	StopScript	Stops recording to script file
Stretch	Stretch	
...	StructurePanel/Close	Opens the Structure panel displaying tree structure of the drawing content
...	+StructurePanel	Opens the Structure panel at a specified tab

AutoCAD Command	BricsCAD Command	Notes
Style, -Style	Style, -Style	BricsCAD uses Explorer for styles
StylesManager	StylesManager	
Subtract	Subtract	
SunProperties / Close	SunProperties	
...	SupportFolder	Opens C:\Users\<login>\AppData\Roaming\Bricsys\BricsCAD\V20x64\en_US\Support
SurfBlend	...	
SurfExtend	dmExtrude	
SurfExtractCurve	dmMove	
SurfFillet	dmFillet	
SurfNetwork	...	
SurfOffset	...	
SurfPatch	...	
SurfSculpt	...	
SurfTrim, SurfUntrim	...	
...	SvgOptions	In BricsCAD, opens Settings dialog at SVG Export section
Sweep	Sweep	
SysVarMonitor	...	
SysWindows	SysWindows	

T Commands

Table	Table, -Table	
TablEdit	TablEdit	
TableExport	TableExport	
...	TableMod	In BricsCAD, edits cells
TableStyle	TableStyle	
Tablet	Tablet	
TabSurf	TabSurf	
...	Tangent	In AutoCAD, use -OSnap Tangent
TargetPoint	...	
Taskbar	...	
TbConfig	...	
TEdit	...	
...	TConnect	Connects faces of adjacent solids
...	TemplateFolder	Opens C:\Users\<login>\AppData\Local\Bricsys\BricsCAD\V20x64\en_US\Templates
...	TestDbUserlo	For developer use in BricsCAD
...	TestDlg	For developer use in BricsCAD
...	TestFatal	For developer use in BricsCAD
...	TestInternal	For developer use in BricsCAD
...	TestSelection	For developer use in BricsCAD
Text, -Text	Text, -Text	
TextAlign	...	
TextEdit	In BricsCAD, use the DdEdit command
TextScr	TextScr	
TextToFront	TextToFront	
...	TfLoad	Opens handle, xsd, and strip data from DWT template files
...	TfSave	Saves handle, xsd, and strip data to DWT template files
Thicken	...	In BricsCAD, use the DmExtrude command
TifOut	...	
Time	Time	

AutoCAD Command	BricsCAD Command	Notes
TInsert	TInsert	
Tolerance	Tolerance	
Toolbar, -Toolbar	Toolbar, -Toolbar	
ToolPalettes / Close	ToolPalettes, ToolPalettesClose	
...	-ToolPanel	Opens tool panels by name at the command bar
Torus	Torus	
TpNavigate	TpNavigate	
...	Trace	Draws wide lines
Transparency	Transparency	
TraySettings	...	
TreeStat	...	
Trim	Trim	
TScale	...	
...	TxtExp	Explodes text

U Commands

U	U	
Ucs	Ucs	
UcsIcon	UcsIcon	
UcsMan, +UcsMan	...	In BricsCAD, use the SetUcs command
ULayers	...	In BricsCAD, use the Layer command
Undefine	Undefine	
Undo	Undo	
...	UndoEnt	Undoes property changes to selected entities
Ungroup	...	In BricsCAD, use the Group command
Union	Union	
UnisolateObjects	UnisolateObjects	
Units	Units, -Units	
UpdateField	UpdateField	
UpdateThumbsNow	...	
...	Url	In AutoCAD, use the Browser command

V Commands

Vbalde	Vbalde	
VbaLoad, -VbaLoad	VbaLoad, -VbaLoad	
VbaMan	VbaMan	
...	VbaNew	
VbaRun, -VbaRun	VbaRun, -VbaRun	
...	VbaSecurity	
VbaStmt	...	
VbaUnload	VbaUnload	
View, -View	View, -View	BricsCAD uses Explorer for views
ViewBase	ViewBase	
ViewComponent	...	
ViewDetail	ViewDetail	
ViewDetailStyle	ViewDetailStyle	
ViewEdit	ViewEdit	
...	ViewExport	Exports drawings from paper space to model space; destroys 3D information

AutoCAD Command	BricsCAD Command	Notes
ViewGo	...	
...	ViewHorizontal	Rotates the viewpoint to make z=0 (horizontal)
...	ViewLabel	Associates sheetset views with numbered labels
ViewPlay	...	
ViewPlotDetails	...	
ViewProj	ViewProj	
ViewRes	ViewRes	
ViewSection	ViewSection	
ViewSectionStyle	ViewSectionStyle	
ViewSetProj	...	
ViewSymbolsSketch / Close	...	
ViewStd	...	In BricsCAD, use the ViewBase command
ViewUpdate	ViewUpdate	
VisualStyles / Close	VisualStyles, -VisualStyles	BricsCAD uses VisualStyles in Explorer
VlIde	VlIde	Opens the Blade Lisp editor
VLisp	...	In BricsCAD, use text editor and VLxxx functions
...	VmlOut	Exports drawings in VML format
VpClip	VpClip	
VpLayer	VpLayer	
VpMax	VpMax	
VpMin	VpMin	
VPoint, -VPoint	VPoint	
VPorts, -Vports	VPorts, -Vports	
VsCurrent	VsCurrent	
VSlide	VSlide	
VsSave	...	In BricsCAD, use VisualStyles in Explorer
VTOptions	VTOptions	
W Commands		
WalkFlySettings	...	
WBlock, -WBlock	WBlock, -WBlock	
...	WCascade	Cascades windows
...	WClose	Closes the current window
...	WCloseAll	Closes all windows
WebLight	WebLight	
WebLoad	...	
Wedge	Wedge	
WhoHas	WhoHas	
...	WhTile	Tiles windows horizontally
...	WiArrange	Arranges iconized windows
WipeOut	WipeOut	
Wmfln	...	To be supported in a future release of BricsCAD
WmfOpts	...	To be supported in a future release of BricsCAD
WmfOut	WmfOut	
...	WNext	In AutoCAD, use drawing tabs
...	WorkSets	In BricsCAD, loads named sets of drawings
WorkSpace	WorkSpace	
...	WPrev	In AutoCAD, use drawing tabs
WsSave, -WsSave	WsSave	

AutoCAD Command	BricsCAD Command	Notes
WsSettings	WsSettings	
...	WvTile	In BricsCAD, tiles windows vertically
X Commands		
XAttach	XAttach	
XBind, -XBind	...	To be supported in a future release of BricsCAD
XClip	XClip	
XData	...	
XDList	...	
XEdges	XEdges	
...	XFaces	Extracts surfaces from 3D solids or surfaces.
XLine	XLine	
XList	...	
...	XmlSave -	Prompts for handles to save in an XML file
XOpen	XOpen	
Xplode	Xplode	
Xref, -XRef	XRef, -XRef	Explorer for external references
Z Command		
...	ZCenter	Toggles 3D osnap to centers of planar and curved 3D faces
...	ZIntersection	Toggles 3D osnap to intersections of linear entities, and edges, as well as the 3D intersections of faces with polar and entity snap tracking lines
...	ZKnot	Toggles 3D osnap at the knots of splines
...	ZMidpoint	Toggles 3D osnap at midpoints of face edges
...	ZNearest	Toggles 3D osnap to points on faces nearest to the cursor
...	ZNone	Disables 3D osnap modes
Zoom	Zoom	
...	ZPerpendicular	Toggles 3D osnap at points perpendicular to faces
...	ZVertex	Toggles 3D osnap to the closest vertex of a 3D entity
# Commands		
...	2dIntersection	In AutoCAD, use -OSnap Intersection
3D	3D	
3dAlign	...	
3dArray	3dArray	
3dClip	...	
...	3DCompare	Compares the 3D content of two drawing files
3dCORbit	...	In BricsCAD, use the RtRot command
...	3dConvert	Converts ACIS solids to polyface meshes
3dDistance	...	
3dDwf	...	In BricsCAD, use 3D DWF option of Export command
3dDwgPublish	...	
3dEditBar	...	
3dFace	3dFace	
3dFly	Navigate	Walk and flythroughs of 3D models
3dFORbit	...	In BricsCAD, use the RtRot command

AutoCAD Command	BricsCAD Command	Notes
...	3dIntersection	In AutoCAD, use -OSnap Intersection
3dMesh	3dMesh	
3dMove	...	In BricsCAD, use Quad cursor's Move option
3dOrbit	...	In BricsCAD, use the RtRot command
3dOrbitCtr	...	
3dOsnap, -3dOsnap	3dOsnap, -3dOsnap	
3dPan	...	In BricsCAD, use the RtPan command
3dPoly	3dPoly	
3dPrint	...	
3dPrintService	...	
3dRotate	...	In BricsCAD, use Quad cursor's Rotate option
3dScale	...	
3dIn	...	
3dSwivel	...	In BricsCAD, use the RtUpDown command
3dWalk	Navigate	Walk and flythroughs of 3D models
3dZoom	...	In BricsCAD, use the RtZoom command

BIM MODELING COMMANDS

BricsCAD constructs architectural models with built-in intelligence, a form of CAD known as BIM (building information modeling). The *bim*- commands are listed separately in this appendix, because AutoCAD does not have this capability. BIM modeling is available through a separate, extra-cost, add-on module to BricsCAD Platinum. See https://www.bricsys.com/en_INTL/BIM/.

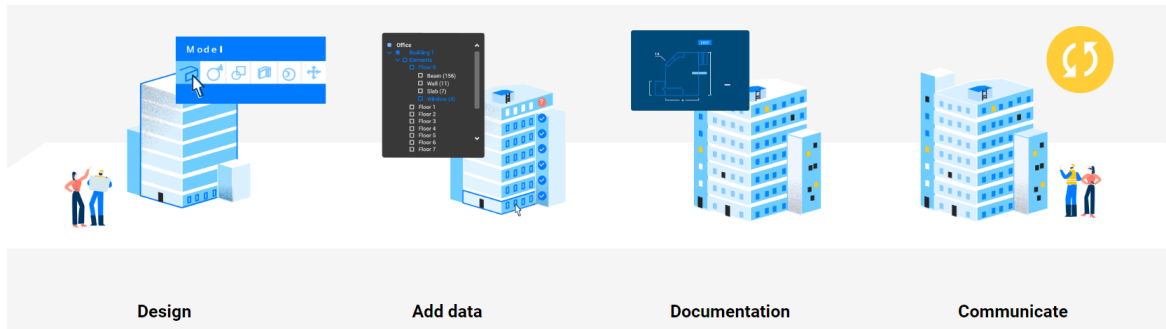

- Command names in **blue** are to new V20.
- **bim** = building information modeling

The following commands are specific to architectural design:

bimAddEccentricity controls relative positions of the axes in linear solids.

bimApplyProfile applies profiles to linear entities and linear solids.

bimAttachComposition attaches BIM compositions (wall styles) to solids.

bimAttachSpatialLocation automatically detects, creates, and assigns buildings and stories.

bimAutoUpdateRoom updates rooms automatically.

bimClassify classifies entities as a wall, slab, column, beam, window, or door.

bimCopy copies entities *normal* (at 90 degrees) to the selected face.

bimCurtainWall creates curtain walls made of planar quadrilateral panels from free-form surfaces.

bimDecompose decomposes composition-based solids into separate plies.

bimDisplayComposition toggles the display of compositions on and off.

bimDrag extends walls or slabs; modifies their thickness.

bimFlip flips starting faces of compositions; mirrors inserts like windows and doors.

bimFlowConnect connects linear solids.

bimGrid creates rectangular and radial grids with automatically-applied labels

bimIfy automatically classifies and spatial locates the entire bim model.

bimInsert and **-bimInsert** insert window and doors.

bimLinearSolid creates chains of linear solids.

bimList reports DXF-style data on BIM entities in drawings.

bimMultiSelect selects one or more coplanar linear solids or parallel axes.

bimParametrizeDetail adds parameters to BIM details

bimPatch reserves an of a BIM model for editing with the RefEdit command.

bimProfiles displays the profiles dialog box for creating and editing profiles.

bimProjectInfo displays the BIM project info dialog box for specifying project library databases.

bimPropagate maps details from selected solids to all similar solids, as well as on grids.

bimPropagateEdges propagates along the edges of planar solids, such as railings.

bimPropagateFromFile and **-bimPropagateFromFile** specifies path to DWG files

bimPropagateLinear propagates connections to linear elements, such as connections to walls and slabs.

bimPropagatePattern propagates a single element (such as a switch) to multiple locations and grids.

bimPropagatePlanar propagates connections to planar elements, such as walls, slabs, and roofs.

bimProperties displays the BIM properties dialog box for specifying and editing properties of bim projects.

bimQuickDraw draws rooms and stories from rectangles and L-shapes.

bimRecalculateAxis recalculates the axes of structural elements back to their centroids.

bimRoom defines room areas with markers.

bimRoomBoundingElements determines which elements (walls, floors, etc) determine bounds of rooms.

bimSchedule generates linked schedule tables after analyze building elements in BIM models.

bimSection creates sections from BIM models.

bimSectionOpen opens drawing files related to BIM sections.

bimSectionUpdate exports BIM sections; also updates BIM sections.

bimSetReferenceFace controls the layout of plys through reference and opposing faces.

bimSpatialLocations displays Buildings and Story Manager dialog box to create and edit their properties.

bimSplit automatically separates segmented solids, or by selection of cutting faces.

bimStair creates straight stairs as a rectangular parametric array.

bimStretch

bimStructuralConnect connects linear solids.

bimTag tags BIM sections.

bimUpdateRoom updates the geometry of the selected room.

bimUpdateThickness reapplies overall thickness of compositions to solids.

bimWindowCreate and **-bimWindowCreate** replace closed entities with parametric window entities.

bimWindowPrint prints windowed areas of models.

bimWindowUpdate updates openings when definitions of doors and windows change.

CIVIL MODELING COMMANDS

(new in V20) BricsCAD includes commands for working with Civil3D files in the BIM edition.

Alignment creates horizontal, vertical, or 3D alignments

AlignmentEdit edits horizontal and vertical alignments

AlignmentView views alignment along TIN surface

AlignmentVinitial creates vertical alignments

Grading interactively modifies TIN surfaces to create grading effects, such as for roads and foundations.

LandXmlEexport exports the drawing in LandXML format

LandXmlImport imports LandXML files into the current drawing

Tin (short for triangulated irregular network) imports data from TIN files to create land surfaces, and converts Civil 3D surfaces to BricsCAD format

TinEdit adds and removes points, break lines, and boundaries in TIN surfaces.

TinExtract creates a mesh or 3D solid between TIN surfaces or between a TIN surface and elevation or verti-

cal offset

TinMerge merges two or more TIN surfaces into a single one

TinModify deforms or smooths TIN surfaces

TinVolume creates a TIN volume surface between a base and TIN surfaces or an elevation

BRICSCAD MECHANICAL COMMANDS

The Platinum edition of BricsCAD includes commands for working with mechanical components and direct modeling and editing. These *bm*- and *dm*- commands are listed separately in this appendix, because AutoCAD does not have this capability.

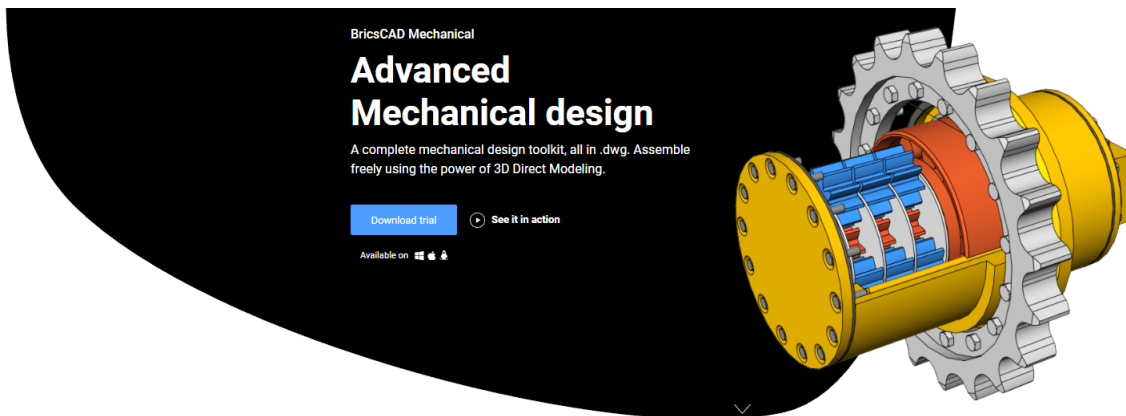

- Command names in **blue** are to new V20.
- **bm** = BricsCAD mechanical
- **dm** = direct modeling

BricsCAD Mechanical Commands

The following *bm*- commands are specific to mechanical drawings:

AnimationEditorOpen opens an editor for creating parametric animations.

bmBalloon attaches associative balloons using predefined and user-defined styles.

bmBom inserts bills of material (BOM) tables into drawings.

bmBomPanelOpen open a panel for configuring bills of materials.

bmCreateComponent and **-bmCreateComponent** create components from selection sets.

bmDependencies lists the names of the files that create assemblies

bmDissolve dissolves mechanical components inserted into drawings

bmExplode explodes assemblies, taking into account physical collisions between components.

bmExplodeMove allows users to created exploded representations of assemblies.

bmExplodeStepEdit edits exploded components

bmExternalize converts local components to external components

bmForm forms new mechanical components and insert them into drawings

bmHardware and **-bmHardware** insert standard hardware parts as mechanical components

bmHide hides mechanical components

bmInsert and **-bmInsert** insert existing mechanical components into drawings

bmLink edits linkages between components

bmLispGet retrieve variables for blocks and parameters of components.

bmLocalize converts external components to local components

bmMassProp calculates mass properties of components, taking into account density

bmMech converts the current drawing into a mechanical component

bmNew creates a new mechanical component as a new drawing

bmOpen opens parts from assemblies for editing

bmOpenCopy creates new drawing with a copy of selected components

-bmParameters changes parameters of components

bmRecover recovers broken mechanical structures

bmReplace replaces component inserts

bmShow shows hidden mechanical components

bmUnlink breaks links between components.

bmUnMech converts mechanical components into plain drawings

bmUpdate updates the hierarchy of mechanical components

bmVStyle specifies the visual style of components

bmXConvert converts now-obsolete X-Hardware solids to mechanical components

3D Constraints Commands

The following commands apply 3D constraints to modes; AutoCAD does not support 3D constraints

dmAngle3D applies 3D angle constraints

dmCoincident3D applies 3D coincident constraints

dmConcentric3D applies 3D concentric constraints

dmConstraint3D is a super command for applying any kind of 3D constraint

dmDistance3D applies 3D distance constraints

dmFix3D applies 3D fix constraints

dmParallel3D applies 3D parallel constraints

dmPerpendicular3D applies 3D perpendicular constraints

dmRadius3D applies 3D radial constraints

dmRigidSet3D turns a group of components into a set, like a group

dmTangent3D applies 3D tangency constraints

Direct Modeling Commands

The following *dm*- commands are specific to direct modeling and editing:

- dmAudit** checks and fixes 3D ACIS models in the current drawing
- dmAuditAll** also checks and fixes 3D ACIS models in externally-referenced drawings
- dmChamfer** chamfers edges
- dmCopyFaces** copies features like holes and ribs to the same or other 3D solids
- dmDeformCurve** deforms by moving or rotating edges to a specified set of target curves
- dmDeformMove** moves or rotates edges
- dmDeformPoint** transforms points lying on specified faces
- dmDelete** erases parts and sub-entities
- dmExtrude** extrudes planar entities and sub-entities
- dmFillet** rounds edges
- dmGroup** creates new groups, edits them, and dissolves groups
- dmMove** moves parts and sub-entities
- dmPushPull** pushes and pulls faces and closed contours
- dmRepair** checks, reports, and optionally fixes errors in 3D solids
- dmRevolve** revolves planar entities and sub-entities
- dmRotate** rotates entities and sub-entities
- dmSelect** selects 3D subentities, like edges, faces, protrusions, fillets, and blend networks
- dmSelectEdges** places faces and solids in a selection set
- dmSimplify** removes unnecessary edges and vertices, merges seam edges, and so on of the current drawing
- dmSimplifyAll** also unnecessary elements in externally referenced drawings
- dmStitch** converts watertight region and surface entities to 3D solids; converts regions to surfaces
- dmThicken** converts surfaces to 3D solids with specified thicknesses
- dmTwist** twists 3D solids by an angle
- dmUpdate** updates 3D models to satisfy constraints

SHEET METAL MODELING COMMANDS

BricsCAD construct sheet metal parts with built-in intelligence; this function is not available in AutoCAD. The sheet metal commands are available in BricsCAD Mechanical, a separate, extra-cost, add-on module to BricsCAD Platinum.

- Command names in **blue** are to new V20.
- **sm** = sheet metal

The following *sm*- commands are specific to sheet metal design:

- smAssemblyExport** converts 3D solid sheet metal parts to DXF files with unfolding information
- smBendCreate** converts sharp edges between flange faces to bends
- SmBendSwitch** converts bends to lofted bends

smConvert recognizes flanges and bends in a 3D solids automatically

smDelete removes junctions by restoring sharp edge between two flanges

smDissolve dissolves sheet metal features

smExplode explodes bends, forms, hem, junctions, and tabs

smExport2D exports sheet metal as unfolded representation of 2D profiles in DXF or DWG format

smExportOsm export a sheet metal designs in Open Sheet Metal (.osm) format

smExtrude extrudes polylines to sheet metal parts

smFlangeBase creates sheet metal models from closed 2D polylines or regions

smFlangeBend bends existing flanges along a line, taking into account the k-factor

smFlangeConnect closes gaps between two flanges; their orientation does not matter

smFlangeContour creates flange from a closed contour

smFlangeEdge bends the sheet metal to make flanges; generates corner and bend reliefs automatically

smFlangeRotate changes the bend angle of flanges

smFlangeSplit removed from V19; replaced by **smSplit**

smFlip switches flange sides to reverse reference faces

smForm adds forms to sheet metal

smHemCreate creates a variety of hems on sheet metal models.

smImprint uses imprinted edges to split thickness faces of sheet metal parts

smJunctionCreate converts hard edges into junctions

smJunctionSwitch changing symmetrical junctions to ones with overlapping faces

smLispGet returns values related to sheet metal variables.

smLispSet changes values related to sheet metal variables.

smLoft constructs sheet metal bodies with lofted bends and flanges

smParametrize generates consistent sets of 3D constraints for sheet metal parts

smReliefCreate creates proper corner and bend reliefs

smReliefSwitch converts corner and bend reliefs to other types

smRepair joins connected lofted bends surrounded by flanges and rebuilds them tangent to adjacent flanges

smReplace replacing form features with ones from libraries

smRibCreate adds associative rib (form) features on sheet metal parts based on 2D profiles

smSelect selects hard edges and form features of sheet metal parts

smSplit splits flanges and lofted bend; replaces the old **smFlangeSplit** command

smTabCreate creates a tab between two flanges.

smUnfold unfolds sheet metal bends

System Variable Cross-reference

THIS APPENDIX COMPARES THE NAMES AND VALUES OF VARIABLES FOUND IN AUTOCAD 2020 and BricsCAD V20, listed in alphabetical order. BricsCAD alone has 1,130 variables; AutoCAD has another 970 of them.

In addition to supporting many AutoCAD-like system variables, BricsCAD employs *preference variables*, which are unique to it and provide greater access to system settings. The table in this chapter uses the following notation:

- ▶ System variables and preference names new since the last edition of this ebook are shown in **blue** text.

Both CAD programs can change the values of variables, when the variables are not read-only. At the command line, enter the **SetVar** command, and then the name of the system or preference variable. For changing their values through dialog boxes, use these commands:

For **AutoCAD** system variables, enter the name in the **SysVDiG** command

For **BricsCAD** system and preference variables, enter the name in the search field of the **Settings** command

AutoCAD System Variable Name	AutoCAD Default Value	BricsCAD Default Value	BricsCAD Preference & System Variable Name	Notes on Variables Unique to BricsCAD
A Variables				
AcadLspAsDoc	0	0	AcadLspAsDoc	
AcadPrefix	c:\users\...	C:\Users\...	AcadPrefix	
AcadVer	18.2	20.0 BricsCAD	AcadVer	
...		-1	AcisHlrResolution	Hidden-line removal resolution
...			AcisOutVer	
...		(not used)	AcisSaveAsMode	Specifies how to save solids to R12
ActPath	""		...	
ActRecorderState	0		...	
ActRecPath	c:\users\...		...	
ActUi	6		...	
...		4	AdaptiveGridStepSize	Sets snap spacing in pixels
Aec3dDwfEdge	Off		...	
AecCbPasteAvailability	0		...	
AecEipinProgress	Off		...	
AecEnableAssocAnchor	On		...	
AecEableSectionCleanup	Off		...	
AecForceDefaultModelView	Off		...	
AecForceDisplayBySizeDisabled	Off		...	
AecForceExplodeToSolid	Off		...	
AecObjectIsolateMode	Off		...	
AecPsdAutoAttach	Off		...	
AecPsdVisibility	0		...	
AFlags	16	0	AFlags	
...		1	AllowBreakLineCrossings	Toggles breakline crossing permission
...		1	AllowBendAngles	Toggles bend angles
...		1	AllowTabExternalMove	Allows one tab to be moved to another spot
...		1	AllowTabMove	Allows tabs to be moved horizontally
...		1	AllowTabSplit	Allows tabs to be split
AngBase	0	0	AngBase	
AngDir	0	0	AngDir	
...		5	AngleSamplingInterval	Angle sampling interval in degrees
AnnoAllVisible	1	On	AnnoAllVisible	
AnnoAutoScale	-4	-4	AnnoAutoScale	
AnnoMonitor	-2		...	
...		0	AnnoSelected	Whether selected entities are annotative
AnnotativeDwg	0	0	AnnotativeDwg	
...		2	AntiAliasRender	Level of anti-aliasing in renderings
...		2	AntiAliasScreen	Level of anti-aliasing in 3D views
ApBox	0	0	ApBox	
Aperture	10	10	Aperture	
AppAutoLoad	14		...	
AppFrameResources	pack://application...		...	
ApplyGlobalOpacities	0		...	
...		0.01	ArcTessellation	Tessellation distance of arcs
Area	0	0	Area	
...		-1	AreaPrec	Number of decimal places for areas
...		"in ft mi um..."	AreaUnits	Units used to convert areas

AutoCAD System Variable Name	AutoCAD Default Value	BricsCAD Default Value	BricsCAD Preference & System Variable Name	Notes on Variables Unique to BricsCAD
ArrayAssociativity	1	1	ArrayAssociativity	
ArrayCreation	0		...	
ArrayEditState	0	0	ArrayEditState	
ArrayType	0	0	ArrayType	
AsmOutVer	70		...	
...		3	Associativity	Toggles associativity of TIN surfaces
AttDia	0	0	AttDia	
AttIpe	0		...	
AttMode	1	1	AttMode	
AttMulti	1		...	
...		3	AttractionDistance	Specifies grips attraction distance
AttReq	1	1	AttReq	
AuditCtl	0	0	AuditCtl	
...		0	AuditErrorCount	Reports number of errors in audit
AUnits	0	0	AUnits	
AuPrec	0	0	AuPrec	
...			AutoAdoptSize	Toggles autosizing of walls and slabs
...		0.3	AutoCompleteDelay	Delay before autocomplete appears
...		15	AutoCompleteMode	Determines the autocomplete functions
AutoDwfPublish	0		...	
...		1	AutoFlipQuarterTurn	Toggles autoflipping of stairs
...		1	AutomaticConnection	Toggles auto creation of BIM connections
...		0	AutomaticTees	Toggles creation of T-flow fittings
AutomaticPub	0		...	
...		1	AutoMenuLoad	Specifies which menu to load
...		0	AutoResetScales	Deletes unused annotations scales
...		1	AutosaveChecksOnlyFirstBitDbMod	Checks first bit only of DbMod for autosave
AutoSnap	63	63	AutoSnap	
...		171	AutoTrackingVecColor	Specifies color of the tracking vector
...		1	AutoUpdateRooms	Toggles if room update when walls change
...		1	AutoVpFitting	Fits model to viewport borders automatically
...		(not used)	AxisMode	Toggles axis display
...		(not used)	AxisUnit	Specifies axis units

B Variables

BackgroundPlot	2	2	BackgroundPlot	
BackZ	0	0	BackZ	
BActionBarMode	1		...	
BActionColor	7	7	BActionColor	
...		""	BaseFile	Specifies default template path & file name
BConStatusMode	0		...	
BDependencyHighlight	1	1	BDependencyHighlight	
BGripObjColor	141	"141"	BGripObjColor	
BGripObjSize	8	8	BGripObjSize	
...		0	bimConnectCutType	Specifies type of structural connection
...		1	bimMatchProp	Matches BIM properties during MatchProp
...		0	bimOsMode	Object snapping to axes of linear BIM solids
BindType	0	0	BindType	

AutoCAD System Variable Name	AutoCAD Default Value	BricsCAD Default Value	BricsCAD Preference & System Variable Name	Notes on Variables Unique to BricsCAD
...		256	BkgColor	Specifies background color
...		256	BkgColorPs	Specifies paper space background color
...		0	Blipmode	Toggles blip marks made by clicking
BlockEditLock	0	0	BlockEditLock	
BlockEditor	0	0	BlockEditor	
BlockMruList	50		...	
BlockNavigate	","		...	
BlockRedefineMode	1		...	
...		C:\Users\...	BlocksPath	Specifies path to blocks for Insert command
...		1	bmAutoUpdate	Specifies when to load external assemblies
...		""	bmFormTemplatePath	Path,name of default bmForm template
...		0	bmReportPanel	Removed from V18
...		0	bmUpdateMode	Specifies how to load external assemblies
...		1000	BndLimit	For internal use by Bricsys
BlockTestWindow	0		...	
...		95	BoundaryColor	Color of detected boundaries
BParameterColor	170	"170"	BParameterColor	
BParameterFont	simplex.shx	"simplex.shx"	BParameterFont	
BParameterSize	12	12	BParameterSize	
BPTextHorizontal	1	1	BPTextHorizontal	
...		0	BSysLibCopyOverwrite	Controls over-copying of materials
BtMarkDisplay	1	1	BtMarkDisplay	
BvMode	0	0	BvMode	
C Variables				
...		1	CacheLayout	Toggles caching of layouts
CacheMaxFiles	256		...	
CacheMaxTotalFiles	1024		...	
CalcInput	1		...	
CameraDisplay	0	0	CameraDisplay	
CameraHeight	0	0	CameraHeight	
CAnnoScale	1:1	1:1	CAnnoScale	
CAnnoScaleValue	1	1	CAnnoScaleValue	
CaptureThumbnails	1		...	
CBarTransparency	50		...	
CConstraintForm	0		...	
CDate	20090722.2	20090722.15	CDate	
CDynDisplayMode	0		...	
CeColor	bylayer	BYLAYER	CeColor	
CeLtScale	1	1	CeLtScale	
CeLtype	bylayer	BYLAYER	CeLtype	
CeLweight	-1	-1	CeLweight	
CenterCrossGap	"0.05x"	"0.05x"	CenterCrossGap	
CenterCrossSize	"0.1x"	"0.1x"	CenterCrossSize	
CenterExe	0.1200	0.1200	CenterExe	
CenterLayer	"Use Current"	.	CenterLayer	
CenterLtScale	1.0000	1.0000	CenterLtScale	
CenterLtype	"Center2"	"Center2"	CenterLtype	

AutoCAD System Variable Name	AutoCAD Default Value	BricsCAD Default Value	BricsCAD Preference & System Variable Name	Notes on Variables Unique to BricsCAD
CenterLtypeFile	"Acad.Lin"	Default.lin"	CenterLtypeFile	
CenterMarkExe	On	1	CenterMarkExe	
CenterMt	0		...	
CeTransparency	ByLayer	ByLayer	CeTransparency	
CGeoCs	''''	''''	CGeoCs	
ChamferA	0	0.5	ChamferA	
ChamferB	0	0.5	ChamferB	
ChamferC	0	1	ChamferC	
ChamferD	0	0	ChamferD	
ChamMode	0	0	ChamMode	
...		0	CheckDwlPresence	Checks for DWL drawing lock file
CircleRad	0	0	CircleRad	
Classickeys	0		...	
CLayer	0	0	CLayer	
CLayout	"Model"		...	
...		0	CleanScreenOptions	Specifies which UI elements to display
CleanScreenState	0	0	CleanScreenState	
...		7	ClipboardFormat	Specifies default DWG format for Clipboard
...		127	ClipboardFormats	Determines Clipboard formats to support
CliPromptLines	10	4	CliPromptLines	
CliPromptUpdate	0		...	
...		1	CliState	Reports visibility of command line
...		0	CloseChecksOnlyFirstBitDbMod	Does not save drawing if it was only viewed
...		"C:\... Bricsys247"	CloudDownloadPath	Path to store downloaded files
...		0	CloudLog	Toggles log that records 24/7 activity
...		0	CloudLogVerbose	Toggles added details in 24/7 log
...		1	CloudModified	Action to take on local modified drawings
...		www.mybricsys247.com	CloudServer	Reports address of 24/7 server
...		"C:\users\... BricsCAD"	CloudSessionPath	Path to cloud session storage
...		"C:\users\..."	CloudTempFolder	Stores name of local 24/7 folder
...		1	CloudUploadDependencies	Specifies files to upload with drawing
...		www.mychapoo.com	ChapooWebsite	Removed from V18
CMaterial	bylayer	''''	CMaterial	
CmdActive	1	1	CmdActive	
CmdDia	1	1	CmdDia	
CmdEcho	1	1	CmdEcho	
CmdInputHistoryMax	20		...	
...		#f8f8f8	CmdLineEditBgColor	Specifies command line background color
...		#000000	CmdLineEditFgColor	Specifies command line foreground color
...		Courier New	CmdLineFontName	Specifies command line font name
...		10	CmdLineFontSize	Specifies command line font size
...		#ffffdd	CmdLineListBgColor	Specifies command line background color
...		#000000	CmdLineListFgColor	Specifies command line foreground color
...		:	CmdLnText	Specifies prompt prefix
CmdNames	setvar	Options	CmdNames	
CmFadeColor	60		...	
CmFadeOpacity	40		...	
CMleaderStyle	standard	standard	CMleaderStyle	
CMJust	0	0	CMJust	

AutoCAD System Variable Name	AutoCAD Default Value	BricsCAD Default Value	BricsCAD Preference & System Variable Name	Notes on Variables Unique to BricsCAD
CMIScale	1	1	CmlScale	
CMISStyle	standard	STANDARD	CmlStyle	
CmOsnap	1		...	
...		1	CmpClrMiss	Drawing compare missing entities color
...		253	CmpClrMode1	Drawing compare drawing 1 entities color
...		2	CmpClrMode2	Drawing compare drawing 2 entities color
...		3	CmpClrNew	Drawing compare new entities color
...		10000000	CmpDiffLimit	Drawing compare entity comparison limit
...		80	CmpFadeCtl	Fade level of unmodified entities
...		0	CmpLog	Toggles output of log files
ColorTheme	0	0	ColorTheme	
...		1	ColorX	Specifies X axis color
...		3	ColorY	Specifies Y axis color
...		5	ColorZ	Specifies Z axis color
...		0	ComAcadCompatibility	Checks registry for VB app compatibility
CommandPreview	1		...	
CompareColor1	82		...	BricsCAD compare variables begin with Cmp
CompareColor2	1		...	
CompareColorCommon	253		...	
CompareFront	1		...	
CompareHatch	Off		...	
CompareProps	0		...	
CompareRcMargin	5		...	
CompareRcShape	0		...	
CompareShow1	On		...	
CompareShow2	On		...	
CompareShowCommon	On		...	
CompareShowRc	On		...	
CompareText	On		...	
CompareTolerance	6		...	
Compass	0	0	Compass	
ComplexLtPreview	1		...	
...		"...\\bim\\Components"	ComponentsPath	Folder for components
ConsolidationMode	3		...	
ConstraintBarDisplay	1		ConstraintBarDisplay	
...		0	ContinuousMotion	Toggles continued motion after release
ConstraintBarMode	4095		...	
ConstraintCursorDisplay	1		...	
ConstraintInfer	0		...	
ConstraintNameFormat	2		...	
ConstraintRelax	0		...	
ConstraintSolveMode	1		...	
...		1	ConvertToArrays	Converts patterns of entities into arrays
Coords	1	1	Coords	
CopyMode	0	0	CopyMode	
CPlotStyle	bicolor	ByColor	CPlotStyle	
CProfile	<<unnamed profile>>	DEFAULT	CProfile	
...		1	CreateThumbnailOnTheFly	Created thumbnail when drawing lacks it
...		1	CreateViewports	Creates viewports in new layouts

AutoCAD System Variable Name	AutoCAD Default Value	BricsCAD Default Value	BricsCAD Preference & System Variable Name	Notes on Variables Unique to BricsCAD
...		2	CrossHairDrawMode	Toggles use of RedSDK for 3D cursor
CrossingAreaColor	100	3	CrossingAreaColor	
CTab	model	Model	CTab	
CTableStyle	standard	STANDARD	CTableStyle	
...		1	Ctrl3DMouse	Toggles use of 3D mouse
...		1	CtrlMButton	Controls use of Ctrl key with mouse buttons
...		1	CtrlMouse	Toggles meaning of mouse shortcuts
CullingObj	1		...	
CullingObjSelection	0		...	
CursorBadge	2		...	
CursorSize	5	5	CursorSize	
CursorType	0		...	
CviewDetailStyle	"Imperial24"		...	
CviewSectionStyle	"Imperial24"		...	
CVPort	2	2	CvPort	

D Variables

DataLinkNotify	2	2	DataLinkNotify	
Date	2455035.85	2455035.63	Date	
...		0	DbcState	Reports if dbConnect Manager is open
DbClkEdit	on	1	DbClkEdit	
DbMod	5	0	DbMod	
DctCust	"c:\users\..."	""	DctCust	
DctMain	enu	en_US.dic	DctMain	
...		2	ddBetweenKnots	Distance between knots on NURBS surfaces
...		0	ddFastMode	Displays faster with more display errors
...		0	ddGridAspectRatio	Specifies the grid aspect ratio
...		0	ddMaxFacetEdgeLength	Specifies Maximum edge length of cell sides
...		1000	ddMaxNumGridLines	Specifies max grid lines for subdivisions
...		15	ddNormalTol	Specifies max deviation between normals
...		0	ddPointsPerEdge	Specifies the number of points per edge
...		0	ddSurfaceTol	Max distance between facet and true edge
...		1	ddUseFacetRes	Toggles use of the FacetRed sysvar
...		0	DefaultBlockName	Toggles use of default block names
...		""	DefaultBSysLibImperial	Points to bsyslib library folder
...		""	DefaultBSysLibMetric	Points to bsyslib library folder
DefaultGizmo	0		...	
DefaultIndex	0		...	
...		0	DefaultInsPoint	Toggles use of a default insertion point
DefaultLighting	1		DefaultLighting	
DefaultLightingType	1		...	
...		8	DefaultLightShadowBlur	Default shadow blur
...		(none)	DefaultNewSheetTemplate	Names .dwg or .dwt as default template
...		120	DefaultRoomHeight	Default height of BIM rooms
DefPIStyle	bycolor	ByColor	DefPIStyle	
DefPStyle	bycolor	ByColor	DefPStyle	
...		1	DeleteInterference	Retains or removes interference solids
...		1	DeleteTool	Toggles deletion of tool entities in Subtract

AutoCAD System Variable Name	AutoCAD Default Value	BricsCAD Default Value	BricsCAD Preference & System Variable Name	Notes on Variables Unique to BricsCAD
DelObj	1	1	DelObj	
DemandLoad	3	3	DemandLoad	
DesignFeedState	1	...		
DgnFrame	0	2	DgnFrame	
...		0	DgnImp2dClosedBSplineCurveImportMode	
...		0	DgnImp2dEllipseImportMode	Determines how 2D ellipses are imported
...		0	DgnImp2dShapeImportMode	Determines how 2D shapes are imported
...		1	DgnImp3dClosedBSplineCurveImportMode	
...		0	DgnImp3dEllipseImportMode	Determines how 3D ellipses are imported
...		0	DgnImp3dObjectImportMode	Determines how 3D entities are imported
...		1	DgnImp3dShapeImportMode	Determines how 3D shapes are imported
...		0	DgnImpBreakDimensionAssociation	
...		0	DgnImpConvertDgnColorIndicesToTrueColors	
...		1	DgnImpConvertEmptyDataFieldsToSpaces	
...		0	DgnImpEraseUnusedResources	Toggles erasing of unreferenced entities
...		0	DgnImpExplodeTextNodes	Determines how text nodes are imported
...		1	DgnImpImportActiveModelToModelSpace	
...		1	DgnImpImportInvisibleElements	Toggles import of invisible entities
...		1	DgnImpImportPaperSpaceModels	
...		-1	DgnImpImportViewIndex	Specifies view settings
...		0	DgnImpRecomputeDimensionsAfterImport	
...		""	DgnImpSymbolResourceFiles	Specifies paths to resource files
...		2	DgnImpXRefImportMode	Determines how xrefs are imported
DgnImportMax	10000000		...	
DgnImportMode	0		...	
DgnImportUnitConversion	0		...	
DgnMappingPath	c:\users\...		...	
DgnOsnap	1	1	DgnOsnap	
DiaStat	1	1	DiaStat	
Digitizer	0		...	
DimConstraintIcon	3		...	
...		0	DisplayAxes	Toggles structural element axes
...		0	DisplayAxesForMep	Toggles display of MEP element axes
...		100	DisplayScaling	Reports OS display scale percentage
...		1	DisplaySidesAndEnds	Toggles display of sides and ends
...		0	DisplaySnapMarkerInAllViews	Toggles snap markers in all viewports
...		1	DisplayTooltips	Displays snap tooltips
DisplayViewCubeIn2d	On		...	
DisplayViewCubeIn3d	On		...	
...		1	DispPaperBkg	Toggles paper space background
...		1	DispPaperMargins	Displays paper space margins
DispSilh	0	0	DispSilh	Displays silhouette curves
Distance	0	0	Distance	
DivMeshBoxHeight	3		...	
DivMeshBoxLength	3		...	
DivMeshBoxWidth	3		...	
DivMeshConeAxis	8		...	
DivMeshConeBase	3		...	
DivMeshConeHeight	3		...	

AutoCAD System Variable Name	AutoCAD Default Value	BricsCAD Default Value	BricsCAD Preference & System Variable Name	Notes on Variables Unique to BricsCAD
DivMeshCylAxis	8		...	
DivMeshCylBase	3		...	
DivMeshCylHeight	3		...	
DivMeshPyrBase	3		...	
DivMeshPyrHeight	3		...	
DivMeshPyrLength	3		...	
DivMeshSphereAxis	12		...	
DivMeshSphereHeight	6		...	
DivMeshTorusPath	8		...	
DivMeshTorusSection	8		...	
DivMeshWedgeBase	3		...	
DivMeshWedgeHeight	3		...	
DivMeshWedgeLength	4		...	
DivMeshWedgeSlope	3		...	
DivMeshWedgeWidth	3		...	
...		1	dmAuditLevel	Direct modeling error messages
...		1	dmAutoUpdate	Toggles auto update of 3D constrained models
...		0	dmExtrudeMode	Specified operation of Auto mode
...		1	dmPushPullSubtract	Toggles if solids are subtracted from solids
...		127	dmRecognize	Determines which 3D constraints are applied
...		1	DockPriority	Determines docking priority of toolbars
...		0	DocTabPosition	Location of drawing tabs
DonutId	0.5	0.5	DonutId	
DonutOd	1	1	DonutOd	
DragMode	2	2	DragMode	
...		0	DragModeHide	Specifies entities to show while dragging
...		1	DragModelInterrupt	Toggles interrupts of redraws
...		1	DragOpen	Inserts or opens dragged files
DragP1	10	10	DragP1	
DragP2	25	25	DragP2	
...		Off	DragSnap	Controls snap behavior while dragging
DragVs	""		...	
...		C:\Users\...	DrawingPath	Additional folders to open drawings
...		"none"	DrawingViewPreset	Presets for the ViewBase command
...		0	DrawingViewPresetHidden	Preset hidden lines for ViewBase
...		""	DrawingViewPresetScale	Preset annotation scale for ViewBase cmd
...		0	DrawingViewPresetTangent	Preset tangent lines for ViewBase
DrawOrderCtl	3	3	DrawOrderCtl	
DTextEd	2		...	
DwfFrame	2	2	DwfFrame	
DwfOsnap	1	1	DwfOsnap	
...		2	DwfVersion	Specifies export format of DWF files
DwgCheck	1	0	DwgCheck	
DwgCodepage	ansi_1252	ANSI_1252	DwgCodepage	
DwgCompareMode	0		...	
DwgName	drawing1.dwg	Drawing1.dwg	DwgName	
DwgPrefix	"c:\users\..."	"C:\Users\..."	DwgPrefix	
DwgTitled	0	0	DwgTitled	
DxEval	12	12	DxEval	

AutoCAD System Variable Name	AutoCAD Default Value	BricsCAD Default Value	BricsCAD Preference & System Variable Name	Notes on Variables Unique to BricsCAD
...		1	DxfTextAdjustAlignment	Adjusts alignment of text from DXF files
DynConstraintDisplay	1		...	
DynConstraintMode	1	1	DynConstraintMode	
DynDiGrip	31	31	DynDiGrip	
...		20	DynDimAperture	Specifies radius in pixels around the cursor
...		142	DynDimColorHot	Specifies dynamic dimension hot color
...		142	DynDimColorHover	Specifies dynamic dimension hover color
...		1	DynDimDistance	Specifies dynamic dimension distance
...		1	DynDimLineType	Specifies dynamic dimension line type
DynDVis	1	1	DynDVis	
DynInfoTips	1		...	
...		65	DynInputTransparency	Specifies dynamic input field transparency
DynMode	-3	2	DynMode	
DynPiCoords	0	0	DynPiCoords	
DynPiFormat	0		...	
DynPiVis	1		...	
DynPrompt	1		...	
DynTooltips	1		...	

Dimension Variables

DimADec	0	0	DimADec	
DimAlt	off	0	DimAlt	
DimAltD	2	2	DimAltD	
DimAltF	25.4	25.4	DimAltF	
DimAltRnd	0	0	DimAltRnd	
DimAltTd	2	2	DimAltTd	
DimAltTz	0	0	DimAltTz	
DimAltU	2	2	DimAltU	
DimAltZ	0	0	DimAltZ	
DimAnno	0	0	DimAnno	
DimAPost	""	""	DimAPost	
DimArcSym	0	0	DimArcSym	
...		1	DimAso	Obsolete variable replaced by DimAssoc
DimAssoc	2	2	DimAssoc	
DimASz	0.18	0.18	DimASz	
DimAtFit	3	3	DimAtFit	
DimAUnit	0	0	DimAUnit	
DimAZin	0	0	DimAZin	
DimBlk	""	""	DimBlk	
DimBlk1	""	""	DimBlk1	
DimBlk2	""	""	DimBlk2	
DimCen	0.09	0.09	DimCen	
DimClrD	0	0	DimClrD	
DimClrE	0	0	DimClrE	
DimClrT	0	0	DimClrT	
DimContinueMode	1		...	
DimDec	4	4	DimDec	
DimDle	0	0	DimDle	

AutoCAD System Variable Name	AutoCAD Default Value	BricsCAD Default Value	BricsCAD Preference & System Variable Name	Notes on Variables Unique to BricsCAD
DimDli	0.38	0.38	DimDli	
DimDsep	.	.	DimDsep	
DimExe	0.18	0.18	DimExe	
DimExo	0.06	0.06	DimExo	
DimFit	3	3	DimFit	
DimFrac	0	0	DimFrac	
DimFxl	1	1	DimFxl	
DimFxlLon	off	0	DimFxlLon	
DimGap	0.09	0.09	DimGap	
DimJogAng	45	45	DimJogAng	
DimJust	0	0	DimJust	
DimLayer	"use current"	""	DimLayer	Default layer for new dimensions
DimLdrBlk	""	""	DimLdrBlk	
DimLfac	1	1	DimLfac	
DimLim	off	0	DimLim	
DimLtEx1	""	""	DimLtEx1	
DimLtEx2	""	""	DimLtEx2	
DimLtype	""	""	DimLtype	
DimLUnit	2	2	DimLUnit	
DimLwD	-2	-1	DimLwD	
DimLwE	-2	-1	DimLwE	
DimPickbox	5		...	
DimPost	""	""	DimPost	
DimRnd	0	0	DimRnd	
DimSah	off	0	DimSah	
DimScale	1	1	DimScale	
DimSd1	off	0	DimSd1	
DimSd2	off	0	DimSd2	
DimSe1	off	0	DimSe1	
DimSe2	off	0	DimSe2	
DimSho	on	on	DimSho	
DimSoxd	off	0	DimSoxd	
DimStyle	standard	STANDARD	DimStyle	
DimTad	0	0	DimTad	
DimTDec	4	4	DimTDec	
DimTFac	1	1	DimTFac	
DimTFill	0	0	DimTFill	
DimTFillClr	0	BYBLOCK	DimTFillClr	
DimTih	on	1	DimTih	
DimTix	off	0	DimTix	
DimTm	0	0	DimTm	
DimTMove	0	0	DimTMove	
DimTofl	off	0	DimTofl	
DimToh	on	1	DimToh	
DimTol	off	0	DimTol	
DimTolj	1	1	DimTolj	
DimTp	0	0	DimTp	
DimTSz	0	0	DimTSz	
DimTVp	0	0	DimTVp	

AutoCAD System Variable Name	AutoCAD Default Value	BricsCAD Default Value	BricsCAD Preference & System Variable Name	Notes on Variables Unique to BricsCAD
DimTxRuler	on		...	
DimTxSty	standard	STANDARD	DimTxSty	
DimTxt	0.18	0.18	DimTxt	
DimTxtDirection	off	0	DimTxtDirection	
DimTzin	0	0	DimTZin	
DimUnit	2	2	DimUnit	
DimUpt	off	0	DimUpt	
DimZin	0	0	DimZin	

E Variables

EdgeMode	0	0	EdgeMode	
Elevation	0	0	Elevation	
...		0	ElevationAtBreakLineCrossings	Elevation at breakline crossings
...		0	EnableAttraction	Enables grips attraction
...		0	EnableBIMBkUpdate	Toggles updates of section in background
...		1	EnableHyperlinkMenu	Toggles hyperlink menu
...		0	EnableHyperlinkTooltip	Toggles hyperlink tooltips
EnterpriseMenu	
ErHighlight	1		...	
...		0	ErrNo	For internal use by Bricsys
Expert	0	0	Expert	
...		0	ExplnsAlign	Aligns blocks with selected entity
...		0	ExplnsAngle	Default angle for inserted blocks
...		1	ExplnsFixAngle	Fixed rotation angle for inserted blocks
...		1	ExplnsFixScale	Fixed scale factor for inserted blocks
...		1	ExplnsScale	Default scale factor for inserted blocks
ExplMode	1	1	ExplMode	
...		0	ExportAcisFormatVersion	Specifies version of exported ACIS files
...		0	ExportCatia4FormatVersion	Specifies version of exported Catia 4 files
...		0	ExportCatia5FormatVersion	Specifies version of exported Catia 5 files
ExportEplotFormat	2		...	
...		0	ExportHiddenParts	Controls how hidden parts are exported
ExportModelSpace	0	0	ExportModelSpace	
ExportPageSetup	0	0	ExportPageSetup	
ExportPaperSpace	0	0	ExportPaperSpace	
...		1	ExportProductStructure	Controls how product structure is exported
...		1	ExportStepFormatVersion	Specifies STEP version
ExpValue	8.8		...	
ExpWhiteBalance	6500		...	
ExtMax	-1e+20,-1e+20,-1e+20	-1e+20,-1e+20,-1e+20	ExtMax	
ExtMin	1e+20,1e+20,1e+20	1e+20,1e+20,1e+20	ExtMin	
ExtNames	1	1	ExtNames	

F Variables

FacetErDevNormal	40		...	
FacetErDevSurface	0		...	
FacetErGridRatio	0		...	

AutoCAD System Variable Name	AutoCAD Default Value	BricsCAD Default Value	BricsCAD Preference & System Variable Name	Notes on Variables Unique to BricsCAD
FacetErMaxEdgeLength	0		...	
FacetErMaxGrid	4096		...	
FacetErMeshType	0		...	
FacetErMinUGrid	0		...	
FacetErMinVGrid	0		...	
FacetErPrimitiveMode	1		...	
FacetErSmoothlev	1		...	
FacetRatio	0	0	FacetRatio	
FacetRes	0.5	0.5	FacetRes	
...		1	FbxExportCameras	Toggles exporting cameras
...		1	FbxExportEntities	Toggles exporting entities
...		0	FbxExportEntitiesSelType	Determines which entities to export
...		1	FbxExportLights	Toggles exporting lights
...		1	FbxExportMaterials	Toggles exporting materials
...		0	FbxExportTextures	Toggles exporting textures
...		"C:\... BricsCAD V20 en_US "	FbxExportTexturesPath	Path to store exported textures
...		1	FeatureColors	Colors solid faces by related features
FieldDisplay	1	1	FieldDisplay	
FieldEval	31	31	FieldEval	
FileDia	1	1	FileDia	
FileTabPreview	1		...	
FileTabState	1		...	
FileTabThumbHover	1		...	
FilletPolyArc	1		...	
FilletRad	0	0	FilletRad	
FilletRad3d	1.0		...	
FillMode	1	1	FillMode	
...		0	FittingRadiusType	Default flow fitting radius type
...		1.5	FittingRadiusValue	Default flow fitting radius
FontAlt	simplex.shx	simplex.shx	FontAlt	
FontMap	"c:\users..."	default.fmp	FontMap	
Frame	3	3	Frame	
FrameSelection	1	1	FrameSelection	
FrontZ	0	0	FrontZ	
FullOpen	1	1	FullOpen	
FullPlotPath	1		...	

G Variables

GalleryView	1		...	
...		3771	GdiObjects	For internal use by Bricsys
...		1	GearTeethNumber	No. of gear teeth created with -bmHardware
...		0	GenerateAssocViews	Associates dimensions in generated views
GeoLatLongFormat	0	1	GeoLatLongFormat	
GeoLocateMode	off		...	
GeoMapMode	0		...	
GeoMarkerVisibility	1	1	GeoMarkerVisibility	
GeoMarkPositionSize	1		...	
...		1	GetStarted	Toggles the Get Started dialog box

AutoCAD System Variable Name	AutoCAD Default Value	BricsCAD Default Value	BricsCAD Preference & System Variable Name	Notes on Variables Unique to BricsCAD
GfAng	0	0	GfAng	
GfClr1	rgb:000,000,255	5	GfClr1	
GfClr2	rgb:255,255,153	7	GfClr2	
GfClrLum	1	1	GfClrLum	
GfClrState	1	0	GfClrState	
GfName	1	1	GfName	
GfShift	0	0	GfShift	
GlobalOpacity	0		...	
...		2	GIswapMode	Sets swap mode for GL graphics
...		"#d2d2d2"	GradientColorBottom	Bottom color of gradient background
...		"#fafafa"	GradientColorMiddle	Middle color of gradient background
...		"#ffffff"	GradientColorTop	Top color of gradient background
...		0	GradientMode	Specifies 0, 2, or 3-color background
...		252	GridAxisColor	Specifies color of grid's axis lines
GridDisplay	2	3	GridDisplay	
GridMajor	5	5	GridMajor	
...		253	GridMajorColor	Specifies color of major grid lines
...		254	GridMinorColor	Specifies color of minor grid lines
GridMode	0	0	GridMode	
GridStyle	0	1	GridStyle	
GridUnit	0.5000,0.5000	10,10,10	GridUnit	
...		1	GridXyzTint	Toggles coloring of x,y,z grid lines
GripBlock	0	0	GripBlock	
GripColor	150	160	GripColor	
GripContour	251		...	
GripDynColor	140	140	GripDynColor	
GripHot	12	240	GripHot	
GripHover	11	150	GripHover	
GripMultifunctional	3		...	
GripObjLimit	100	100	GripObjLimit	
Grips	1	1	Grips	
GripSize	5	5	GripSize	
GripSubobjMode	1		...	
GripTips	1	1	GripTips	
GroupDisplayMode	2		...	
...		0	GsDeviceType2D	Selects graphics system for wireframes
...		0	GsDeviceType3D	Specifies graphics system for hidden, etc.
GtAuto	1		...	
GtDefault	0		...	
GtLocation	1		...	
H Variables				
HaloGap	0	0	HaloGap	
Handles	1	1	Handles	
HatchBoundSet	0		...	
HatchCreation	0		...	
HatchType	0		...	
...		6'-8"	Headroom	Minimum stair height

AutoCAD System Variable Name	AutoCAD Default Value	BricsCAD Default Value	BricsCAD Preference & System Variable Name	Notes on Variables Unique to BricsCAD
HelpPrefix	"C:\Program..."		...	
...		0	HidePrecision	Accuracy of hidden line removal and shading
...		0	HideSystemPrinters	Hides system printer from Plot dialog box
HideText	on	1	HideText	
HideXrefScales	1	1	HideXrefScales	
Highlight	1	1	Highlight	
...		142	HighlightColor	Specifies highlight color
...		0	HighlightEffect	Specifies color use for highlighting
...		1	HorizonBkg_Enable	Toggles horizon in perspective views
...		"#878787"	HorizonBkg_GroundHorizon	Color of ground at horizon
...		"#5F5F5F"	HorizonBkg_GroundOrigin	Color of the ground
...		"#239BFF"	HorizonBkg_SkyHigh	Color of the sky at high elevation
...		"#FFFFFF"	HorizonBkg_SkyHorizon	Color of sky at horizon
...		"#FAFAFF"	HorizonBkg_SkyLow	Color of the sky at low elevation
...		1	HotkeyAssistant	Toggles display of hotkey assistant (ex Tips)
HpAng	0	0	HpAng	
HpAnnotative	0	0	HpAnnotative	
HpAssoc	1	1	HpAssoc	
HpBackgroundColor	"."	"NONE"	HpBackgroundColor	
HpBound	1	1	HpBound	
HpBoundRetain	0	0	HpBoundRetain	
HpColor	"."	"."	HpColor	
HpDlgMode	2		...	
HpDouble	0	0	HpDouble	
HpDrawOrder	3	3	HpDraworder	
HpGapTol	0	0	HpGapTol	
HpInherit	0		...	
HpIslandDetection	1	0	HpIslandDetection	
HpIslandDetectionMode	1		...	
HpLastPattern	"Ansi31"		...	
HpLayer	"Use Current"	"."	HpLayer	
HpLinetype	Off	Off	HpLinetype	
HpMaxArea	100	0	HpMaxAreas	
HpMaxLines	1000000		...	
HpName	ansi31	ANSI31	HpName	
HpObjWarning	10000	10000	HpObjWarning	
HpOrigin	0.0000,0.0000	0,0	HpOrigin	
HpOriginMode	0		...	
HpOriginStoreAsDefault	0		...	
HpPickMode	0		...	
HpQuickPreview	On		...	
HpQuickPreviewTimeout	2		...	
HpRelativePs	Off		...	
HpScale	1	1	HpScale	
HpSeparate	0	0	HpSeparate	
HpSpace	1	1	HpSpace	
...		0	HpStyle	Determines hatching of islands
HpTransparency	"."	"."	HpTransparency	
HyperlinkBase	.	.	HyperlinkBase	

AutoCAD System Variable Name	AutoCAD Default Value	BricsCAD Default Value	BricsCAD Preference & System Variable Name	Notes on Variables Unique to BricsCAD
I Variables				
IBEnvironment	0		...	
...		0	IfcExplodeExternalReferences	Explodes external references
...		0	IfcExportBaseQuantities	Derives base quantities from BIM entities
...		1	IfcExportElementsOnOffAndFrozenLayer	
...		0	IfcExportMultiplyElementsAsAggregated	
...		0	IfcExportTessellation	Specifies tessellation level for exports
...		1	IfcImportBimData	Imports BIM data from IFC files
...		0	IfcImportBrepGeometryAsMeshes	Imports b-rep surfaces as meshes
...		0	IfcImportModelOrigin	Determines location of model's origin
...		0	IfcImportParametricComponents	Imports components from IFC files
...		0	IfcImportProjectStructureAsXrefs	Imports structure as xrefs
...		0	IfcImportSpaces	Imports spaces from IFC files
...		C:\Users\<login>\...	ImageCacheFolder	Path to folder storing image cache files
...		160	ImageCacheMaxMemory	Maximum RAM to reserve for image cache
...		1	ImageDiskCache	Toggles use of the disk cache for images
ImageFrame	1	1	ImageFrame	
ImageHlt	0	0	ImageHlt	
...		0	ImageNotify	Alert for missing raster attachments
...		1	ImportColors	Specifies how to import colors
...		""	ImportCreoAlternateSearchPaths	Paths to product structure folders for Creo
...		0	ImportCuiFileExists	Prompt, overwrite, or rename imported CUI
...		0	ImportHiddenParts	Specifies how to import hidden parts
...			ImportIfcProjectStructureAsXrefs	Removed from V20
...		1	ImportIgesSimplify	Simplify IGES model upon import
...		1	ImportIgesStitch	Stitch IGES model upon import
...		""	ImportInventorAlternateSearchPaths	
...		""	ImportNxAlternateSearchPaths	Paths to product structure folders for NX
...		1	ImportPmi	Import product mfg'ing information
...		2	ImportProductStructure	Import product structure
...		0	ImportRepair	Repair model upon import
...		0	ImportSimplify	Simplify model upon import
...		""	ImportSolidEdgeAlternateSearchPaths	
...		""	ImportSolidworksAlternateSearchPaths	
...		1	ImportSolidworksRotateYZ	Convert Solidworks coords to BricsCAD
...		0	ImportStepRotateYZ	Convert STEP coords to BricsCAD
...		0	ImportStitch	Stitch model upon import
...		1	IncludePlotStamp	Toggles plot stamp on plots
Impliedface	1		...	
IndexCtl	0	0	IndexCtl	
InetLocation	www.autodesk.com	www.bricsys.com	InetLocation	
InputHistoryMode	15		...	
InputSearchDelay	300		...	
InsBase	0,0,0,0,0,0	0;0;0	InsBase	
InsName	.	.	InsName	
InsUnits	1	1	InsUnits	
InsUnitsdefSource	1	1	InsUnitsdefSource	
InsUnitsdefTarget	1	1	InsUnitsdefTarget	

AutoCAD System Variable Name	AutoCAD Default Value	BricsCAD Default Value	BricsCAD Preference & System Variable Name	Notes on Variables Unique to BricsCAD
...		1	InsUnitsScaling	Controls use of InsUnits variable
IntelligentUpdate	20		...	
InterfereColor	1	"ByLayer"	InterfereColor	
...		"Interferences"	InterfereLayer	Layer for interference solids
InterfereObjVs	realistic	""	InterfereObjVs	
InterfereVpVs	3d wireframe	""	InterfereVpVs	
...		20	InteriorElevationMinLength	Minimum elevation of BIM interiors
...		2	InteriorElevationOffset	Offset of volume box from BIM walls
IntersectionColor	257		IntersectionColor	
IntersectionDisplay	off	0	IntersectionDisplay	
ISaveBak	1	1	ISaveBak	
ISavePercent	50	50	ISavePercent	
Isolines	4	4	Isolines	

L Variables

LargeObjectSupport	0		...	
LastAngle	0	0	LastAngle	
LastPoint	5;7;13;5;0.0	0;0;0	LastPoint	
LastPrompt	lastangle	: options	LastPrompt	
Latitude	37.8	37.7950	Latitude	
LayerDlgMode	1		...	
LayerEval	0		...	
LayerEvalCtl	1		...	
LayerFilterAlert	2		...	
...		250	LayerFilterExcess	Deletes layer filters exceeding this value
LayerNotify	0		...	
LayerOverrideHighlight	0		...	
...		1	LayerPMode	Toggles tracking of layer changes
LayLockFadeCtl	50	50	LayLockFadeCtl	Amount of fading of locked layers
LayoutCreateViewport	1		...	
LayoutRegenCtl	2	2	LayoutRegenCtl	
...		40	LengthSamplingInterval	TIN surface sampling interval
...		""	LengthUnits	Units permissible for length conversions
LayoutTab	1	1	LayoutTab	
LegacyCodeSearch	off	0	LegacyCodeSearch	
LegacyCtrlPick	0		...	
LensLength	50	50	LensLength	
...		31	LicExpDays	Number of day at which license expires
...		0	LicFlags	Specifies if components are licensed
...		""	LicKey	Reports software license number
...		30	LightGlyphColor	Specifies color of light glyphs (icons)
LightGlyphDisplay	1	1	LightGlyphDisplay	
LightingUnits	2	0	LightingUnits	
LightsInBlocks	1		...	
...		1	LightWebGlyphColor	Specifies color of glyphs of web lights
LimCheck	0	0	LimCheck	
LimMax	12.0000,9.0000	12;9	LimMax	
LimMin	0.0000,0.0000	0;0	LimMin	

AutoCAD System Variable Name	AutoCAD Default Value	BricsCAD Default Value	BricsCAD Preference & System Variable Name	Notes on Variables Unique to BricsCAD
...		0	LinearBrightness	Scale factor for light intensity
...		0	LinearContrast	Ambient light intensity
LineFading	on		...	
LineFadingLevel	2		...	
...		1	LispInit	Preserves LISP functions between sessions
...		0	LoadMechanical2D	Toggles loading of mechanical enablers
Locale	enu	enu	Locale	
...		c:\users\...	LocalRootFolder	Specifies path to local root folder
LocalRootPrefix	c:\users\...	c:\users\...	LocalRootPrefix	
LockUi	0	0	LockUi	
LoftAng1	90	1.5708	LoftAng1	
LoftAng2	90	1.5708	LoftAng2	
LoftMag1	0	0	LoftMag1	
LoftMag2	0	0	LoftMag2	
LoftNormals	1	1	LoftNormals	
LoftParam	7	7	LoftParam	
LogFileMode	0	0	LogFileMode	
LogFileName	"c:\users\..."	""	LogFileName	
LogFilePath	"c:\users\..."	"c:\users\..."	LogFilePath	
LogInName	<login>	BricsCAD user	LogInName	
Longitude	-122.39	-122.3940	Longitude	
...		1	LookFromDirectionMode	Specifies number of LookFrom directions
...		1	LookFromFeedback	LookFrom help in tooltips or on status bar
...		1	LookFromZoomExtents	Zoom to extents with each LookFrom pick
LtGapSelection	1		...	
LtScale	1	1	LtScale	
LUnits	2	2	LUnits	
LuPrec	4	4	LuPrec	
LwDefault	211	25	LwDefault	
LwDisplay	off	0	LwDisplay	
...		0.55	LwDispScale	Specifies lineweight display scale
LwUnits	1	1	LwUnits	

M Variables

...		3.5	M_ArrowheadLengthCoeff	Length of manipulator arrow
...		2.5	M_ArrowheadRadiusCoeff	Radius of manipulator arrow
...		6	M_AxisDiameter	Diameter of manipulator axis
...		130	M_TotalAxisLength	Length of manipulator axis
...		0	MacroRec	Reports that macro is being recorded
MacroTrace	0	0	MacroTrace	
...		2	Manipulator	Toggles display of manipulator widget
...		0	ManipulatorColorTheme	Toggles color and monochrome themes
...		250	ManipulatorDuration	Millisecs before manipulator widget appears
...		1	ManipulatorSize	Specifies the relative size of the widget
...		-1	MassPrec	Number of decimal places for mass props
...		0.01	MassPropAccuracy	Specifies accuracy for mass properties
...		"oz lbs stone mg..."	MassUnits	Units for displaying mass of objects
...		""	MaterialsPath	Path to folder holding materials definitions

AutoCAD System Variable Name	AutoCAD Default Value	BricsCAD Default Value	BricsCAD Preference & System Variable Name	Notes on Variables Unique to BricsCAD
MaxActVp	64	64	MaxActVp	
...		100000	MaxHatch	
MaxSort	1000	1000	MaxSort	
MaxTouches	0		...	
...		0	MaxThreads	Specifies max threads for redraw, regen, loads
...		0	MbState	Reports if Mechanical Browser is open
MButtonPan	1	1	MButtonPan	
MeasureInit	0	1	MeasureInit	
Measurement	0	1	Measurement	
...		2013	Mech2DSaveFormat	Specifies 2D Mechanical save format
MenuBar	0	1	MenuBar	
MenuCtl	1	1	MenuCtl	
MenuEcho	0	0	MenuEcho	
MenuName	"c:\users\..."	"default"	MenuName	
MeshType	1		MeshType	
...		1	MiddleClickClose	Closes tabs with middle-button click
...		732374555	MilliSecs	Reports milliseconds since BricsCAD started
MirrHatch	0		...	
MirrText	0	0	MirrText	
MLeaderScale	1	1	MLeaderScale	
ModeMacro	""	""	ModeMacro	
MsLtScale	1	1	MsLtScale	
MsOleScale	1	1	MsOleScale	
MTextAutoStack	1		...	
MTextColumn	2	0	MTextColumn	
MTextDetectSpace	1	1	MTextDetectSpace	
MTextEd	internal	Internal	MTextEd	
MTextFixed	2	2	MTextFixed	
MTextToolBar	2		...	
...		0	MtFlags	Controls multi-core redraws, loads, regens
MTJigString	abc		...	
...		3	MultiSelectAngularTolerance	Angle at which solids are considered parallel
MViewPreview	0		...	
...		"c:\users\..."	MyDocumentsFolder	Path and name of MyDocuments folder
MyDocumentsPrefix	"c:\users\..."	"c:\users\..."	MyDocumentsPrefix	

N Variables

NavBarDisplay	1		...	In BricsCAD, use Lookfrom widget
NavsWheelMode	2		...	
NavsWheelOpacityBig	50		...	
NavsWheelOpacityMini	50		...	
NavsWheelSizeBig	1		...	
NavsWheelSizeMini	1		...	
NavVCubeDisplay	1	1	NavVCubeDisplay	
NavVCubeLocation	0	0	NavVCubeLocation	
NavVCubeOpacity	50	50	NavVCubeOpacity	
NavVCubeOrient	1	1	NavVCubeOrient	
NavVCubeSize	4	4	NavVCubeSize	

AutoCAD System Variable Name	AutoCAD Default Value	BricsCAD Default Value	BricsCAD Preference & System Variable Name	Notes on Variables Unique to BricsCAD
...		1	NearestDistance	Specifies which distance to display
...		4	NFileList	Specifies length of recent file list
NoMutt	0	0	NoMutt	
NorthDirection	0	0	NorthDirection	

O Variables

ObjectIsolationMode	0	0	ObjectIsolationMode	
ObscuredColor	257	257	ObscuredColor	
ObscuredLtype	0	0	ObscuredLtype	
OffsetDist	-1	1	OffsetDist	
...		0	OffsetErase	Determines if source entities are erased
OffsetGapType	0	0	OffsetGapType	
OleFrame	2	2	OleFrame	
OleHide	0	0	OleHide	
OleQuality	3	3	OleQuality	
OleStartup	0	0	OleStartup	
...		1	OpmState	Reports if Properties panel is open
...		1	OrbitAutoTarget	Specifies location of RtRot target point
OnlineUserId	"200999252999419"		...	
OnlineUsername	"jonhenrydoe"		...	
OrbitAutoTarget	1		...	
OrthoMode	0	0	OrthoMode	
OsMode	4133	4133	OsMode	
OsnapCoord	2	2	OsnapCoord	
OsnapHatch	0		...	
OsnapZ	0	0	OsnapZ	
OsOptions	3	1	OsOptions	

P Variables

PaletteOpaque	2		...	
...		1	PanBuffer	Buffers pans
...		1	PanelButtonSize	Specifies panel button size, in pixels
PaperUpdate	0	0	PaperUpdate	
ParameterCopyMode	1	1	ParameterCopyMode	
ParameterStatus	0		...	
...		0	ParasolidModeler	Specifies Parasolid export version
PcmState	0		...	
...		2	PdfCache	Toggles the PDF cache
...		1	PdfEmbeddedTtf	Embeds fonts in PDF output
...		2	PdfExportSolidHatchType	Min resolution of solid hatches saved to PDF
PdfFrame	1	1	PdfFrame	
...		3000	PdfHatchToBmpDpi	Resolution of hatches exported to PDF
...		1	PdfImageAntiAlias	Anti-aliases images being upscaled.
...		1	PdfImageCompression	Specifies compression for images.
...		300	PdfImageDPI	Minimum resolution of images saved to PDF
...		1	PdfImportApplyLineweight	Toggles lineweights of imported entities
...		0	PdfImportAsBlock	Imports PDF entities as a block

AutoCAD System Variable Name	AutoCAD Default Value	BricsCAD Default Value	BricsCAD Preference & System Variable Name	Notes on Variables Unique to BricsCAD
...		0	PdfImportConvertSolidsToHatches	Imports PDF solid entities as filled hatches
PdfImportFilter	8		...	
PdfImportImagePath		"PDF Images"	PdfImportImagePath	
...		1	PdfImportJoinLineAndArcSegments	Joins segments as polylines
PdfImportLayers	0		...	
...		0	PdfImportLayersUseType	Determines layers for imported PDF file
PdfImportMode	6		...	
...		0	PdfImportRasterImages	Attaches raster PDF content as images
...		1	PdfImportSolidFills	Toggles import of PDF solid fills
...		1	PdfImportTrueTypeText	Toggles import of TTF text as TTF text
...		0	PdfImportTrueTypeTextAsGeometry	Toggles import of TTF as entities
...		1	PdfImportUserGeometryOptimization	
...		1	PdfImportVectorGeometry	Toggles import of PDF vector content
...		1	PdfLayersSetting	Includes layers in PDF files
...		0	PdfLayoutsToExport	Exports content of all layouts
...		0	PdfMergeControl	Specifies the look of overlapping lines
...		0	PdfNotify	Alert for missing PDF attachments
PdfOsnap	1	1	PdfOsnap	
...		297	PdfPaperHeight	Overrides paper height in PDF files
...		0	PdfPaperSizeOverride	Overrides paper size in PDF files
...		210	PdfPaperWidth	Overrides paper width in PDF files
...		0	PdfPRCCompression	Determines PRC compression level
...		0	PdfPRCExport	Determines how PRC data is exported
...		1	PdfPRCSingleViewMode	Toggles single view for PRC data
...		300	PdfRenderDPI	Minimum resolution of renders saved to PDF
PdfShx	1		...	
...		0	PdfShxTextAsGeometry	Exports SHX text as geometry
...		1	PdfSimpleGeomOptimization	Optimizes geometry in PDF files
...		0	PdfTtfTextAsGeometry	Exports TTF text as geometry
...		1	PdfUsePlotStyles	Uses plot styles when plotting to PDF
...		2400	PdfVectorResolution	Specifies resolution of vector data
...		1	PdfZoomToExtentsMode	Zooms to extents mode in PDF files
PdMode	0	0	PdMode	
PdSize	0	0	PdSize	
PeditAccept	0	0	PEditAccept	
PEllipse	0	0	PEllipse	
Perimeter	0	0	Perimeter	
Perspective	0	0	Perspective	
PerspectiveClip	5		...	
PfacevMax	4	4	PFaceVMax	
PickAdd	1	1	PickAdd	
PickAuto	1	1	PickAuto	
PickBox	3	3	PickBox	
PickDrag	0	0	PickDrag	
PickFirst	1	1	PickFirst	
PickStyle	0	1	PickStyle	
...		1	PictureExportScale	Specifies scale factor for raster exports
...		0	PictureFolder1	Sets folder for storing raster images
...		1	PictureFolder2	Sets folder for storing raster images

AutoCAD System Variable Name	AutoCAD Default Value	BricsCAD Default Value	BricsCAD Preference & System Variable Name	Notes on Variables Unique to BricsCAD
...		3	PictureFolder3	Sets folder for storing raster images
...		5	PictureFolder4	Sets folder for storing raster images
_PkSer	""	""	_PkSer	
Platform	varies	varies	Platform	
...		0	PLineCache	Creates a cache of polyline vertices
PLineConvertMode	0	0	PLineConvertMode	
PLineGCenMax	50000		...	
PLineGen	0	0	PLineGen	
PLineReverseWidths	0		...	
PLineType	2	2	PLineType	
PLineWid	0	0	PLineWid	
...		c:\users\...	PlotCfgPath	Specifies plotter configuration path
...		""	PlotId	Deprecated; included for compatibility
PlotOffset	0		...	
...		c:\program files...	PlotOutputPath	Specifies path to plot output folder
PlotRotMode	2	2	PlotRotMode	
PlotTransparencyMode	1		...	
...		c:\users\...	PlotStylePath	Specifies path to plot styles
...		0	Plotter	Specifies path to plotter cfg folder
...		1	PlotterTransparencyOverride	Overrides setting in Print dialog box
PlQuiet	0	0	PlQuiet	
PointCloud2dDisplay	0		...	
...		1	PointCloud2dVsDisplay	Hides 2D wireframe bounding box warning
PointCloudAutoUpdate	1		...	
PointCloudBoundary	1	1	PointCloudBoundary	
PointCloudCacheSize	512		...	
PointCloudClipFrame	2		...	
PointCloudDensity	15		...	
PointCloudLighting	2		...	
PointCloudLightSource	0		...	
PointCloudLod	10		...	
PointCloudPointMax	1500000	4000000	PointCloudPointMax	
PointCloudPointMaxLegacy	1500000		...	
PointCloudPointSize	2	2	PointCloudPointSize	
PointCloudRtDensity	5		...	
PointCloudShading	0		...	
PointCloudVizRetain	1		...	
PolarAddAng	.	.	PolarAddAng	
PolarAng	90	90	PolarAng	
PolarDist	0	0	PolarDist	
PolarMode	0	0	PolarMode	
PolySides	4	4	PolySides	
Popups	1	1	Popups	
...		0	PpState	For developer use
PreSelectionEffect	1		...	
PreviewCreationTransparency	60		...	
PreviewDelay	0		...	
...		30	PreviewDelay	Delays sub-entity highlighting under cursor
PreviewFilter	7	7	PreviewFilter	

AutoCAD System Variable Name	AutoCAD Default Value	BricsCAD Default Value	BricsCAD Preference & System Variable Name	Notes on Variables Unique to BricsCAD
PreviewType	0	0	PreviewType	
...		1	PreviewWndInOpenDlg	Displays preview window in Open dialog box
...		"."	PrintFile	Specifies alternative name for print files
...		1	PrintPdfPreview	Toggles between system and external viewer
...		BricsCAD	Product	Reports the product name
...		1	ProgBar	Toggles progress bar
...		BricsCAD	Program	Reports the product name
...		0	ProjectionType	Determines 1st or 3rd angle projection
ProjectName	.	.	ProjectName	
...		""	ProjectSearchPaths	Specifies project names & search paths
ProjMode	1	1	ProjMode	
PropertyPreview	1		...	
PropObjLimit	25000		...	
PropPrevTimeout	1		...	
...		3	PromptMenu	Toggles prompt menu
...		0	PromptMenuFlags	Toggles hidden prompts
...		0	PromptOptionFormat	Formats prompts at the command line
...		1	PromptOptionTranslateKeywords	Toggles use of international commands
...		1	PropertyPreview	Entities preview changed properties
...		500	PropertyPreviewDelay	Milliseconds to wait before previewing
...		500	PropertyPreviewObjLimit	Max number of entities to preview
...		1	PropPrevTimeout	Max seconds property preview takes place
...		103	PropUnits	Determines automatic formatting of units
ProxyGraphics	1	1	ProxyGraphics	
ProxyNotice	1	1	ProxyNotice	
ProxyShow	1	1	ProxyShow	
...		1	ProxyWebSearch	
PsLtScale	1	1	PsLtScale	
PsolHeight	4	80	PSolHeight	
PsolWidth	0.25	5	PSolWidth	
PsProlog	.	""	PsProlog	
PsQuality	75	75	PsQuality	
PStyleMode	1	1	PStyleMode	
PStylePolicy	1	1	PStylePolicy	
PsVpScale	0	0	PsVpScale	
PublishAllSheets	1	1	PublishAllSheets	
PublishCollate	1		...	
PublishHatch	1		...	
PUCsBase	.	.	PUCsBase	

Q Variables

QpLocation	0		...	
QpMode	1		...	
...		0	QaFlags	For internal use by Bricsys
QtextMode	0	0	QtextMode	
...			QuadAperture	Removed from V20
...		1	QuadCommandLaunch	If Quad launches with application
...			QuadCommandSort	Removed from V20

AutoCAD System Variable Name	AutoCAD Default Value	BricsCAD Default Value	BricsCAD Preference & System Variable Name	Notes on Variables Unique to BricsCAD
...		1	QuadDisplay	Toggles display of the Quad cursor
...		110	QuadExpandDelay	Delay before expanding, in msec
...		50	QuadExpandTabDelay	Delay before expanding underlying buttons
...		0	QuadExpandGroup	Removed from V20
...		0	QuadGoTransparent	Toggles Quad's transparent
...		1000	QuadHideDelay	Quad cursor display delay after mouse movement
...		40	QuadHideMargin	Delay before Quad is hidden, in msec
...		16	QuadIconSize	Toggles between large and small icon
...		1	QuadIconSpace	Specifies spacing between icons
...		2	QuadMostRecentItems	Number of most-recent items on Quad
...		1	QuadPopupCorner	Location of Quad relative to cursor
...		500	QuadShowDelay	Quad display delay after entity highlight
...		12	_QuadTabFlags	Determines style of quad
...		1200	QuadTooltipDelay	Delay before tooltips appear, in msec
...		4	QuadWarpPointer	Removed from V20
...		5	QuadWidth	Specifies width of Quad, in columns
QvDrawingPin	0		...	
QvLayoutPin	0		...	
R Variables				
RasterDpi	300		...	
RasterPercent	20		...	
...		1	RasterPreview	Determines whether preview saved with file
RasterThreshold	20	...		
...		0	Re_Init	
...		5	RealtimeSpeedup	Skips messages during realtime pan
...		1	RealWorldScale	Renders materials at real-world scale factor
Rebuild2dCv	6		...	
Rebuild2dDegree	3		...	
Rebuild2dOption	1		...	
RebuildDegreeU	3		...	
RebuildDegreeV	3		...	
RebuildOptions	1		...	
RebuildU	6		...	
RebuildV	6		...	
...		C:\Users\...	RecentPath	Specifies recently used path
RecoverAuto	0		...	
RecoveryMode	2		...	
...		50	RedHiliteFull_Edge_Alpha	Transparency of hidden edges
...		#FFFFFF	RedHilite_HiddenEdge_Color	Color of hidden edges
...		1	RedHilite_HiddenEdge_Smoothing	
...		1	RedHilite_HiddenEdge_Thickness	
...		100	RedHiliteFull_Edge_Alpha	Transparency of edges
...		#007AFF	RedHiliteFull_Edge_Color	Color of edges
...		0	RedHiliteFull_Edge_ShowHidden	Toggle visibility of hidden edges
...		1	RedHiliteFull_Edge_Smoothing	Toggle smoothness of edges
...		2	RedHiliteFull_Edge_Thickness	Thickness of edges, in pixels
...		10	RedHiliteFull_Face_Alpha	Transparency of faces

AutoCAD System Variable Name	AutoCAD Default Value	BricsCAD Default Value	BricsCAD Preference & System Variable Name	Notes on Variables Unique to BricsCAD
...		#007AFF	RedHiliteFull_Face_Color	Color of faces
...		100	RedHilitePartial_SelectedEdge_Alpha	
...		#007AFF	RedHilitePartial_SelectedEdge_Color	
...		1	RedHilitePartial_SelectedEdge_ShowGlow	
...		1	RedHilitePartial_SelectedEdge_Smoothing	
...		2	RedHilitePartial_SelectedEdge_Thickness	
...		75	RedHilitePartial_SelectedEdgeGlow_Alpha	
...		#FFFFFF	RedHilitePartial_SelectedEdgeGlow_Color	
...		1	RedHilitePartial_SelectedEdgeGlow_Smoothing	
...		3	RedHilitePartial_SelectedEdgeGlow_Thickness	
...		10	RedHilitePartial_SelectedFace_Alpha	Transparency of selected faces
...		#007AFF	RedHilitePartial_SelectedFace_Color	Color of selected faces
...		1	RedHilitePartial_UnselectedEdge_ShowHidden	
...		0	RedSdkLineSmoothing	Toggles smoothing of 3D entities
...		0	ReduceLengthType	Default flow fitting reduction
...		0.5	ReduceLengthValue	Default flow fitting length
...		0	RefEditLockNotInWorkset	Locks entities not being edited by RefEdit
RefEditName	""	""	RefEditName	
RefPathType	1		...	
RegenMode	1	1	RegenMode	
...		1	RegExpand	How paths are stored in registry
RememberFolders	1	1	RememberFolders	
RenderLevel	5		...	
...		1	RenderMaterialDownload	Toggles download of missing materials
RenderLightCalc	1		...	
RenderTarget	0		...	
RenderTime	10		...	
...		C:\ProgramData\...	RenderMaterialPath	Path to folder with materials
...		C:\Program Files\...	RenderMaterialStaticPath	Path to folder with read-only materials
RenderUserLights	1		...	
...		1	RenderUsingHardware	Toggles use of hardware for rendering
ReportError	1		...	
...		0	ReportPanel	Removed from V20
...		0	ReportPanelMode	Specifies style of Report panel
...		1	RestoreConnections	Toggles BIM connector restoration
...		0	RevCloudArcStyle	Specifies revision cloud arc style
RevCloudCreateMode	1	1	RevCloudCreateMode	
RevCloudGrips	on	1	RevCloudGrips	
...		0.38	RevCloudMaxArcLength	Specifies revision cloud max arc length
...		0.38	RevCloudMinArcLength	Specifies revision cloud min arc length
...		1	RhinoVersion	Specifies 3DM file format
RibbonBgLoad	1		...	
RibbonContextSelLim	2500		...	
RibbonDockedHeight	0	120	RibbonDockedHeight	
RibbonIconResize	1		...	
RibbonSelectMode	1		...	
RibbonState	1	0	RibbonState	
...		7"	Riserheight	Default height of stair risers
...		c:\users\...	RoamableRootFolder	Path to user's Roaming folder

AutoCAD System Variable Name	AutoCAD Default Value	BricsCAD Default Value	BricsCAD Preference & System Variable Name	Notes on Variables Unique to BricsCAD
RoamableRootPrefix	"c:\users\..."	c:\users\...	RoamableRootPrefix	
RolloverOpacity	0	100	RolloverOpacity	
...		2	RolloverSelectionSet	Toggles single and selection set displays
RolloverTips	1	1	RolloverTips	
...		10'	RoomHeight	Default height of rooms
RtDisplay	1	1	RtDisplay	
...		1	RtRotationSpeedFactor	Specifies turning speed
...			RtWalkSpeedFactor	Removed from V20
...		40	RubberbandColor	Rubber band color
...		1	RubberbandStyle	Toggles dashing of rubber band
...		2	RunAsLevel	License level: 0=Classic, 1=Pro, 2=Platinum

S Variables

SafeMode	0	0	SafeMode	
...		1	SaveChangeToLayout	Saves print changes to layout
SaveFidelity	1	1	SaveFidelity	
SaveFile	"c:\users\..."	""	SaveFile	
SaveFilePath	"c:\users\..."	C:\Users\..."	SaveFilePath	
...		1	SaveFormat	Sets the DWG file format
...		1	SaveLayerSnapshot	Saves layer settings with views
SaveName	Drawing1.dwg	""	SaveName	
...		0	SaveOnDocSwitch	Saves drawing when switching to another
...		1	SaveRoundTrip	Saves entities to preserve them
SaveTime	10	0	SaveTime	
ScreenBoxes	0	26	ScreenBoxes	
ScreenMode	3	1	ScreenMode	
ScreenSize	1366.0,499.0	1560,779,0	ScreenSize	
...		256	ScrHist	Specifies number of lines saved in history
...		0	Sdi	Toggles single-document interface
...		0	SearchAll	Toggles search set option
SectionOffsetInc	6.0		...	
...		0.2	SectionScale	Viewport scale of generated section
...		""	SectionSettingsSearchPath	Search path to BIM sections, tag styles
...		""	SectionSheetsetTemplateImperial	Name of imperial template for sheetsets
...		""	SectionSheetsetTemplateMetric	Name of metric template for sheetsets
SectionThicknessInc	1.0		...	
SecureLoad	1	1	SecureLoad	
SecureRemoteAccess	1		...	
SelectionAnnoDisplay	1	1	SelectionAnnoDisplay	
SelectionArea	1	1	SelectionArea	
SelectionAreaOpacity	25	25	SelectionAreaOpacity	
SelectionCycling	0		...	
SelectionEffect	1		...	
SelectionEffectColor	0		...	
...		0	SelectionModes	Subentities or boundaries to highlight
SelectionOffscreen	1		...	
SelectionPreview	3	3	SelectionPreview	
SelectionPreviewLimit	2000		...	

AutoCAD System Variable Name	AutoCAD Default Value	BricsCAD Default Value	BricsCAD Preference & System Variable Name	Notes on Variables Unique to BricsCAD
SelectionViewstate	0		...	
SelectSimilarMode	130	130	SelectSimilarMode	
SetByLayerMode	127		...	
ShadEdge	3	3	ShadEdge	
ShadeDif	70	70	ShadeDif	
ShadowPlaneLocation	0		...	
SharedViewState	0		...	
SharedViewProperties	0		...	
SharedViewType	0		...	
...		1	SheetNumberLeadingZeroes	Number of zeros to prefix sheet numbers
...		1	SheetSetAutoBackup	Makes backups of sheet files
...		C:\Users\...	SheetSetTemplatePath	Path to the sheetset templates folder
ShortcutMenu	11	2	ShortcutMenu	
ShortcutMenuDuration	250	250	ShortcutMenuDuration	
...		1	ShowDocTabs	Toggles drawing tabs on
...		0	ShowFullPathInTitle	Displays full path in title bar
ShowHist	1		...	
ShowLayerUsage	0	0	ShowLayerUsage	
ShowmotionPin	1		...	
ShowPageSetupForNewLayouts	0	...		
...		1	ShowScrollButtons	Toggles display of scroll buttons
...		0	ShowTabCloseButton	Toggles display of Close button on tabs
...		0	ShowTabCloseButtonActive	Toggles display of Close button on active tab
...		1	ShowTabCloseButtonAll	Toggles display of Close button on all tabs
...		1	ShowTabControls	Removed from V20
...		1	ShowWindowListButton	Toggles display of droplists
ShpName	""	""	ShpName	
SigWarn	1		...	
...		0	SingletonMode	Toggles multiple BricsCAD instances
...		1	SkpStich	Stitches SketchUp surfaces on import
SketchInc	0.1	0.1	SketchInc	
SkPoly	0	0	SkPoly	
SkTolerance	0.5		...	
SkyStatus	0	0	SkyStatus	
...		10"	SlabThickness	Default thickness of slabs
...		"0"	smAssemblyExportReportPathType	Toggles type of path, absolute or relative
...		"1"	smAssemblyExportSolidTypesInReports	Specifies solids to include in reports
...		7	smAttributesLayerColor	smUnfold, smExport2D attributes layer color
...		0.01	smAttributesLayerTextHeight	Text height on attributes layer
...		0	smAttributesLayerTextHeightType	Determines how text height is established
...		5	smBendAnnotationsLayerColor	smUnfold, smExport2D text layer color
...		0.01	smBendAnnotationsLayerTextHeight	Text height on annotations layer
...		0	smBendAnnotationsLayerTextHeightType	Determines how text height is established
...		1	smBendLinesDownLayerColor	Color of downward bend lines
...		"Continuous"	smBendLinesDownLayerLinetype	Linetype of downward bend lines
...		-3	smBendLinesDownLayerLineweight	Lineweight of downward bend lines
...		1	smBendLinesUpLayerColor	Color of upward bend lines
...		"Continuous"	smBendLinesUpLayerLinetype	Linetype of upward bend lines
...		-3	smBendLinesUpLayerLineweight	Lineweight of upward bend lines

AutoCAD System Variable Name	AutoCAD Default Value	BricsCAD Default Value	BricsCAD Preference & System Variable Name	Notes on Variables Unique to BricsCAD
...		#FFDC50	smColorBend	Color of sheet metal bends
...		#64D296	smColorBendRelief	Color of sheet metal reliefs
...		#64D296	smColorCornerRelief	Color of sheet metal corners
...		#90A4AE	smColorFlange	Color of sheet metal flanges
...		#68a4ae	smColorFlangeReferenceSide	Color of reference side of flange
...		#8791e1	smColorForm	Color of form entities
...		#FF6E40	smColorJunction	Color of sheet metal junctions
...		#A0DCFA	smColorLoftedBend	Color of sheet metal lofted bends
...		#af46d8	smColorMiter	Color of miter entities
...		#ff3300	smColorWrongBend	Color of entities with wrong bends
...		7	smContoursLayerColor	Layer color for unfolded geometry
...		"continuous"	smContoursLayerLinetype	Layer linetype for unfolded geometry
...		30	smContoursLayerLineweight	Layer lineweight for unfolded geometry
...		0	smConvertPreferFormFeatures	Default form from recognition
...		0	smConvertRecognizeHoles	Determines how holes are recognized
...		0	smConvertRecognizeRibControlCurves	
...		0	smDefaultBendlineExtentType	Specifies how bend lines are determined
...		0.25	smDefaultBendlineExtentValue	Bend lines stretch distance
...		2	smDefaultBendRadiusType	Specifies how bend radii are determined
...		1	smDefaultBendRadiusValue	Initial bend radius
...		0	smDefaultBendReliefWidthType	Specifies how bend relief wide is determined
...		0.5	smDefaultBendReliefWidthValue	Initial bend relief width value
...		-1	smDefaultCornerReliefDiameterValue	
...		0	smDefaultFlangeSplitExtensionType	
...		0.1	smDefaultFlangeSplitExtensionValue	
...		0	smDefaultFlangeSplitGapType	Specifies how flange split gap is determined
...		0.1	smDefaultFlangeSplitGapValue	Initial flange split gap value
...		4	smDefaultFormFeatureUnfoldMode	
...		0	smDefaultJunctionAlignmentToRelief	
...		0	smDefaultJunctionGapType	Specifies how junction gap is determined
...		0.001	smDefaultJunctionGapValue	Initial junction gap value
...		0.27324	smDefaultKFactor	Initial location ratio of unfolded surface
...		0	smDefaultReliefExtensionType	Specifies how relief extension is determined
...		0.1	smDefaultReliefExtensionValue	Initial relief extension value
...		0	smDefaultRibFilletRadiusType	Specifies how rib radius is determined
...		5	smDefaultRibFilletRadiusValue	Initial rib fillet radius value
...		0	smDefaultRibProfileRadiusType	Specifies how rib radius is determined
...		2	smDefaultRibProfileRadiusValue	Initial round rib value
...		0	smDefaultRibRoundRadiusType	Initial type of round rib radius
...		1	smDefaultRibRoundRadiusValue	Initial round rib radius
...		5	smDefaultSharpBendRadiusLimitRatio	
...		0.078740157480315	smDefaultThickness	Initial sheet metal thickness
...		0.000393701	smExportOSMAproximationAccuracy	
...		0.001968505	smExportOSMMinimalEdgeLength	
...		6	smFormFeaturesDownColor	Color of form features after unfolding
...		"continuous"	smFormFeaturesDownLayerLinetype	
...		-3	smFormFeaturesDownLayerLineweight	
...		6	smFormFeaturesUpColor	Color of form features after unfolding
...		"continuous"	smFormFeaturesUpLayerLinetype	

AutoCAD System Variable Name	AutoCAD Default Value	BricsCAD Default Value	BricsCAD Preference & System Variable Name	Notes on Variables Unique to BricsCAD
...		-3	smFormFeaturesUpLayerLineweight	
...		0	smJunctionCreateHealCoincident	
...			smLayerColorAnnotations	Removed from BricsCAD V19
...			smLayerColorBendAnnotations	Removed from BricsCAD V19
...			smLayerColorBendLine	Removed from BricsCAD V19
...			smLayerColorContours	Removed from BricsCAD V19
...		3	smOverallAnnotationsLayerColor	
...		"Continuous"	smOverallAnnotationsLayerLinetype	
...		3	smOverallAnnotationsLayerLineweight	
...		3	smParametrizeHolesParametrization	
...		0	smRepairLoftedBendMerge	Specifies whether lofted bends are merged
...		3	smSmartFeatures	Toggles rebuilding of sheet metal features
...		1	smSplitConvertBendToJunction	Toggles conversion of bends to junctions
...		0	smSplitHealCoincident	Toggles healing of miter faces
...		0	smSplitOrthogonalBendSplit	Toggles ortho split behavior
...		""	smTargetCAM	Specifies the intended CAM system
SmoothMeshConvert	0		...	
SmoothMeshGrid	3		...	
SmoothMeshMaxFace	838300		...	
SmoothMeshMaxLev	4		...	
SmState	0		...	
SnapAng	0	0	SnapAng	
SnapBase	0.0000,0.0000	0;0	SnapBase	
SnapGridLegacy	0		...	
SnapIsoPair	0	0	SnapIsoPair	
...		2	SnapMarkerColor	Specifies snap marker color
...		6	SnapMarkerSize	Specifies snap marker size
...		2	SnapMarkerThickness	Specifies snap marker thickness
SnapMode	0	0	SnapMode	
SnapStyl	0	0	SnapStyl	
SnapType	0	0	SnapType	
SnapUnit	0.5000,0.5000	0.5;0.5	SnapUnit	
SolidCheck	1	1	SolidCheck	
SolidHist	1		...	
SortEnts	127	96	SortEnts	
SortOrder	1		...	
SplDegree	3		...	
...		0	spaAdjustMode	Smooths triangles
...		10	spaCheckLevel	Level of ACIS entity checking
...		0	spaGridAspectRatio	Specifies aspect ratio of cell grids
...		0	spaGridMode	Specifies location of grids
...		0	spaMaxFacetEdgeLength	Specifies max length of a side of cell
...		512	spaMaxNumGridLines	Specifies max no. of grid lines in subdivisions
...		0	spaMinUGridLines	Specifies max no. of grid lines in u direction
...		0	spaMinVGridLines	Specifies max no. of grid lines in v direction
...		15	spaNormalTol	Specifies the normal tolerance
...		-1	spaSurfaceTol	Specifies maximum surface tolerance
...		1	spaTriangMode	Specifies which mesh is triangulated
...		1	spaUseFacetRes	Toggles use of FacetRes sysvar

AutoCAD System Variable Name	AutoCAD Default Value	BricsCAD Default Value	BricsCAD Preference & System Variable Name	Notes on Variables Unique to BricsCAD
SplFrame	0	0	SplFrame	
SplineSegs	8	8	SplineSegs	
SplineType	6	6	SplineType	
SplKnots	0		...	
SplMethod	0		...	
SplPeriodic	1		...	
...		c:\users\...	SrchPath	Specifies search paths for support files
SsFound	""	""	SsFound	
SsLocate	1	1	SsLocate	
SsmAutoOpen	1	1	SsmAutoOpen	
SsmPollTime	60	15	SsmPollTime	
SsmSheetStatus	2	2	SsmSheetStatus	
...		0	SsmState	Reports if Sheetset palette is open
...		0	StackPanelType	Specifies type of panel stacking
...		3'4"	StairWidth	Default width of stairs
...		0.2	StampFontSize	Height of plot stamp font
...		Arial	StampFontStyle	Name of plot stamp font
...		""	StampFooter	Default footer text
...		0	StampFooterOffsetX	Footer x-offset in plot stamps
...		0	StampFooterOffsetY	Footer y-offset in plot stamps
...		""	StampHeader	Default header text
...		0	StampHeaderOffsetX	Header x-offset in plot stamps
...		0	StampHeaderOffsetY	Header y-offset in plot stamps
...		""	StampHeader	Default header text
...		0	StampUnits	Units of font size, inches or mm
StandardsViolation	2		...	
StartInFolder	c:\users\...		...	
StartMode	1		...	
Startup	0	0	Startup	
StatusBar	1	1	StatusBar	
StepSize	6	6	StepSize	
StepsPerSec	2	2	StepsPerSec	
...		2"	StepThickness	Default thickness of stair treads
...		1	StlPositiveQuadrant	Move coordinate to all-positive quadrant
...		"mechanical.cst"	StructureTreeConfig	Name of structure configuration file
StudentDrawing	0		...	
SubObjSelectionMode	0		...	
SunStatus	0		...	
SupressAlerts	Off		...	
SurfaceAssociativity	1		...	
SurfaceAssociativityDrag	1		...	
SurfaceAutoTrim	0		...	
SurfaceModelingMode	0		...	
SurfOffsetConnect	0		...	
SurfTab1	6	6	Surftab1	
SurfTab2	6	6	Surftab2	
SurfTrimAutoExtend	1		...	
SurfTrimProjection	0		...	
SurfType	6	6	SurfType	

AutoCAD System Variable Name	AutoCAD Default Value	BricsCAD Default Value	BricsCAD Preference & System Variable Name	Notes on Variables Unique to BricsCAD
SurfU	6	6	SurfU	
SurfV	6	6	SurfV	
...		0	SvgBlendedGradients	Toggles use of blended gradients
...		".png"	SvgDefaultImageExtension	Specifies default file name extension
...		0	SvgGenericFontFamily	Specifies name of generic font family
...		""	SvgImageBase	Specifies path to folder for saving SVG files
...		""	SvgImageUrl	Specifies URL for locating SVG files
...		1	SvgLineweightScale	Specifies pixel width of lineweights
...		768	SvgOutputHeight	Specifies height in points (72 points per inch)
...		1024	SvgOutputWidth	Specifies width in points
...		6	SvgPrecision	Specifies double-floating point precision
...		0	SvgScaleFactor	Determines how drawings are scaled
SyscodePage	ansi_1252	ANSI_1252	SysCodePage	
SysMon	1		...	

T Variables

...		25	TabControlHeight	Specifies height of document tab, in pixels
TableIndicator	1		...	
TableToolBar	2		...	
TabMode	0	0	TabMode	
...		0	TabsFixedWidth	Forces all tabs to have the same width
...		0	TangentLengthType	Default flow fitting tangent length type
...		0	TangentLengthValue	Default flow fitting tangent length value
Target	0.0;0.0;0.0	0.0;0.0;0.0	Target	
TbShowShortcuts	"Yes"		...	
TbShowShortcuts	On		...	
...		0	TeeTangentLengthType	Specifies how T-length is determined
...		0.5	TeeTangentLengthValue	Default length
TdCreate	2455034.61	2455035.58	TdCreate	
TdInDwg	1.24	1.16E-008	TdInDwg	
TduCreate	2455034.9	2455035.88	TduCreate	
TdUpdate	2455034.61	2455035.58	TdUpdate	
TdUsrTimer	1.24	1.16E-008	TdUsrTimer	
TduUpdate	2455034.9	2455035.88	TduUpdate	
...		c:\users\...	TemplatePath	Specifies path to templates folder
TempOverrides	1		...	
TempPrefix	"c:\users\..."	""	TempPrefix	
...		0	TestFlags	For internal use by Bricsys
TextAlignMode	9		...	
TextAlignSpacing	2		...	
TextAllCaps	1		...	
...		0	TextAngle	Stores last-used angle for text
TextAutoCorrectCaps	1		...	
TextEd	2	0	TextEd	
TextEditMode	0	0	TextEditMode	Toggles automatic text entity selection
TextEditor	0		...	
TextEval	0	0	TextEval	
TextFill	1	1	TextFill	

AutoCAD System Variable Name	AutoCAD Default Value	BricsCAD Default Value	BricsCAD Preference & System Variable Name	Notes on Variables Unique to BricsCAD
TextJustify	""		...	
TextOutputFileFormat	0		...	
TextQlty	50	50	TextQlty	
TextSize	0.2	0.2	TextSize	
TextStyle	standard	STANDARD	TextStyle	
...		C:/program...	TextureMapPath	Specifies path to texture map folders
Thickness	0	0	Thickness	
...		0	ThreadDisplay	Toggles display of threads
ThumbSave	1		...	
ThumbSizezd	0		...	
ThumbSize	1	1	ThumbSize	
TileMode	1	1	TileMode	
...		1	TileModeLightSynch	Synchronizes lighting in all viewports
TimeZone	-8000	-8000	TimeZone	
...			Tips	Replaced in V19 with HotkeyAssignment
...			ToolbarIconSize	Replaced in V19 with ToolButtonSize
...		0	ToolbarMargin	Spacing between rows, in pixels
...		0	ToolButtonSize	Size of toolbar buttons, in pixels
...		0	ToolIconPadding	Spacing between toolbar buttons, in pixels
...		C:\users\...	ToolPalettePath	Path to the tool palette files folder
ToolTipMerge	0		...	
Tooltips	1	1	Tooltips	
TooltipSize	0		...	
TooltipTransparency	0		...	
TouchMode	0		...	
...		0	TpState	Reports whether Tools palette is open
...		0.05	TraceWid	
TrackPath	0	0	TrackPath	
TransparencyDisplay	1	1	TransparencyDisplay	
TrayIcons	1	1	TrayIcons	
TrayNotify	1	1	TrayNotify	
...		11-1/2"	TreadLength	Default depth of stair treads
TrayTimeout	0	0	TrayTimeout	
TreeDepth	3020	3020	TreeDepth	
TreeMax	10000000	10000000	TreeMax	
TrimMode	1	1	TrimMode	
TrustedDomains	*.autodesk.com		...	
TrustedPaths	;		...	
TSpaceFac	1	1	TSpaceFac	
TSpaceType	1	1	TSpaceType	
TStackAlign	1	2	TStackAlign	
TStackSize	70	70	TStackSize	
...		3	TtfAsText	Toggles TTF export fonts as text or vectors
U Variables				
Ucs2dDisplaySetting	1		...	
Ucs3dParaDisplaySetting	1		...	
Ucs3dPerpDisplaySetting	1		...	

AutoCAD System Variable Name	AutoCAD Default Value	BricsCAD Default Value	BricsCAD Preference & System Variable Name	Notes on Variables Unique to BricsCAD
UcsAxisAng	90	90	UcsAxisAng	
UcsBase	WORLD	""	UcsBase	
UcsDetect	1	1	UcsDetect	
UcsFollow	0	0	UcsFollow	
UcsIcon	3	3	UcsIcon	
...		0	UcsIconPos	Toggles non-origin UCS icon position
UcsName	""	""	UcsName	
UcsOrg	0.0,0.0,0.0	0;0;0	UcsOrg	
UcsOrtho	1	1	UcsOrtho	
UcsSelectMode	1		...	
UcsView	1	1	UcsView	
UcsVp	1	1	UcsVp	
UcsXDir	1.0,0.0,0.0	1;0;0	UcsXDir	
UcsYDir	0.0,1.0,0.0	0;1;0	UcsYDir	
UndoCtl	53	1	UndoCtl	
UndoMarks	0	5	UndoMarks	
UnitMode	0	0	UnitMode	
UOsnap	1		...	
UpdateThumbnail	15		...	
...		1	UseBIM	Removed from V20
...		1	UseCommunicator	Reports if Communicator license active
...		1	UseMechanical	Removed from V20
UserI1-5	0	0	UserI1-5	
UserR1-5	0	0	UserR1-5	
UserS1-5	""	""	UserS1-5	
...		2	UseSheetMetal	Removed from V20
...		0	UseStandardOpenFileDialog	Displays additional folder in file dialog boxes

V Variables

...		1	VbaMacros	Toggles enabling of VBA macros
...		Bricsys	VendorName	Reports the vendor's name
...		1	VerboseBimSectionUpdate	Toggles diagnostics from bimSectionUpdate
...		16.1.04 (UNICODE)	VerNum	Reports the version number
...		235	VersionCustomizableFiles	Reports version number of CUI and PGP files
ViewBackStatus	Off		...	
ViewCreation	0		...	
ViewCtr	18.9,8.7,0.0	18.9,8.7,0.0	ViewCtr	
ViewDetailCreation	0		...	
ViewDetailEditor	0		...	
ViewDir	0.0,0.0,1.0	10.4;4.5;0.0	ViewDir	
ViewEditor	0		...	
ViewFwdStatus	Off		...	
ViewMode	0	16	ViewMode	
ViewSectionCreation	0		...	
ViewSectionEditor	0		...	
ViewSize	14.65	16	ViewSize	
ViewSketchMode	0	1	...	
ViewTwist	0	1	ViewTwist	

AutoCAD System Variable Name	AutoCAD Default Value	BricsCAD Default Value	BricsCAD Preference & System Variable Name	Notes on Variables Unique to BricsCAD
ViewUpdateAuto	1	1	ViewUpdateAuto	
VisRetain	1	1	VisRetain	
VisRetainMode	0		...	
...		-1	VolumePrec	Decimal places for volume units
...		"in ft mi um..."	VolumeUnits	Format of volume units
VpControl	1		...	
VpLayerOverrides	0		...	
VpLayerOverridesMode	1		...	
VpMaximizedState	0		...	
VpRotateAssoc	1	1	VpRotateAssoc	
VsCurvatureHigh	1.0		...	
VsCurvatureLow	-1.0		...	
VsCurvatureType	0		...	
VsDraftangleHigh	3		...	
VsDraftangleLow	-3		...	
VsZebraColor1	"Rgb:255,255,255"		...	
VsZebraColor2	"Rgb:0,0,0"		...	
VsZebraDirection	90		...	
VsZebraSize	45		...	
VsZebraType	1		...	
VsBackgrounds	1		...	
VsEdgeColor	byentity		...	
VsEdgeJitter	-2		...	
VsEdgeOverhang	-6		...	
VsEdges	1		...	
VsEdgeSmooth	1		...	
VsEdgeLEx	-6		...	
VsFaceColorMode	0		...	
VsFaceHighlight	-30		...	
VsFaceOpacity	-60		...	
VsFaceStyle	0		...	
VsHaloGap	0		...	
VsHidePrecision	0		...	
VsIntersectionColor	"7 (white)"		...	
VsIntersectionEdges	0		...	
VsIntersectionLtype	1		...	
VsIsoOnTop	0		...	
VsLightingQuality	1		...	
VsMaterialMode	0		...	
VsMax	119.3,59.5,0.0	1E+20,1E+20,1E+20	VsMax	
VsMin	-81.3,-42.1,0.0	-1E+20,-1E+20,-1E+20	VsMin	
VsMonoColor	"Rgb:255,255,255"		...	
VsObscuredColor	"ByEntity"		...	
VsObscuredEdges	1		...	
VsObscuredLtype	1		...	
VsOccludedColor	"ByEntity"		...	
VsOccludedEdges	1		...	
VsOccludedLtype	1		...	
VsShadows	0		...	

AutoCAD System Variable Name	AutoCAD Default Value	BricsCAD Default Value	BricsCAD Preference & System Variable Name	Notes on Variables Unique to BricsCAD
VsSilhEdges	0		...	
VsSilhWidth	5		...	
VtDuration	750	750	VtDuration	
VtEnable	3	3	VtEnable	
VtFps	7	7	VtFps	
VToolMotion	0		...	

W Variables

...		10"	WallWidth	Default width of walls
...		1	WarningMessages	Toggles use of warning messages
WbDefaultBrowser	2		...	
WbHelpOnline	1		...	
WbHelpType	1		...	
WhipArc	0	0	WhipArc	
...			3	WhipThread
WindowAreaColor	150	5	WindowAreaColor	
WipeoutFrame	2	2	WipeoutFrame	
WmfBkgnd	off	0	WmfBkGnd	
WmfForegnd	off	0	WmfForeGnd	
...		2	WndlMain	Reports window state, maximized or other
...			WndlScrl	Replaced in V20 by Scrollbar
...			WndlStat	Replaced in V20 by Statusbar
...			WndlTabs	Replaced in V20 by LayoutTabs
...		0	WndlText	Reports text window state
...		2162.0;202.0	WndPMain	Reports top left window position
...		40.0;40.0	WndPText	Reports top left text window
...		1160.0;760.0	WndSMain	Reports main window size
...		1120.0;720.0	WndSText	Reports text window size
WorkingFolder	c:\users\...		...	
WorkspaceLabel	0		...	
WorldUcs	1	1	WorldUcs	
WorldView	1	1	Worldview	
WriteStat	1	1	WriteStat	
WsAutosave	0		WsAutosave	
WsCurrent	2D drafting & annotation	2D Drafting	WsCurrent	

X Variables

XClipFrame	2	0	XClipFrame	
XDwgFadeCtl	70	70	XDwgFadeCtl	
XEdit	1	1	XEdit	
XFadeCtl	50	50	XFadeCtl	
XLoadCtl	2	2	XLoadCtl	
XLoadPath	"c:\users\..."	"C:\Users\..."	XLoadPath	
...		5	XNotifyTime	Minutes between checks for refs
XRefCtl	0	0	XRefCtl	
XRefLayer	"use current"		...	
XRefNotify	2	1	XRefNotify	

AutoCAD System Variable Name	AutoCAD Default Value	BricsCAD Default Value	BricsCAD Preference & System Variable Name	Notes on Variables Unique to BricsCAD
XRefOverride	0	0	XRefOverride	
XrefRegAppCtl	0		...	
XRefType	0		...	

Z Variables

ZoomFactor	60	60	ZoomFactor	
ZoomWheel	0	60	ZoomWheel	

Variables

...		3	3dCompareMode	Visualization for compare mode
3dConversionMode	1		...	
3dDwfPrec	2		...	
3dOsMode	11	11	3dOsMode	
3dSelectionMode	1		...	
...		5	3dSnapMarkerColor	Color of the 3D snap marker

Keystroke & Button Cross-reference

THIS APPENDIX COMPARES THE DEFAULT SHORTCUT KEYSTROKES AND BUTTONS defined by BricsCAD and AutoCAD. The definitions are sorted into the following groups:

Keyboard shortcuts that are used in the drawing area

- › Function keys
- › **Ctrl** keys
- › **Shift** keys
- › Other keys

Keyboard shortcuts that are used in the command bar and Text window

- › **Ctrl** and other keys

Mouse and tablet buttons

- › Mouse buttons
- › Tablet buttons
- › 3D walk and fly controls
- › 3D mouse controls and buttons

To learn how to customize all aspects of BricsCAD, see the *Customizing BricsCAD* ebook available from the https://www.bricsys.com/en_INTL/ Web site.







Keyboard Shortcuts for the Drawing Area

Both BricsCAD and AutoCAD define new shortcuts and buttons, and modify existing ones:

- AutoCAD uses the **Cui** command's **Keyboard Shortcuts** node
- BricsCAD uses the **Customize** command's **Keyboard** tab

FUNCTION KEYS

The following keystroke shortcuts operate in the drawing area:

AutoCAD Action	AutoCAD Command(s)	Windows & Linux Shortcut	MacOS Shortcut	BricsCAD Command(s)	BricsCAD Action
Displays the Help dialog box	Help	F1	F1	Help	Displays the Help dialog box
Selects entire objects during subentity selection	...	Shift+F1	
Toggles between text and graphics windows	TextScr, GraphScr	F2	F2	TextScr, GraphScr	Toggles between Text and Graphics windows
Selects vertex subobjects	...	Shift+F2	Shift+F2	CommandLine CommandLineHide	Toggles the command bar
Toggle Text window	TextScr, GraphScr	Ctrl+F2	Cmd+F2	Ribbon RibbonClose	Toggles the ribbon
Toggles object snap mode	-Osnap	F3	F3	OsMode	Toggles object snap mode
Selects edge subobjects	...	Shift+F3	Shift+F3	StatBar	Toggles the status bar
Toggles 3D object snap mode	3dOsnap	F4	F4	Tablet T	Toggles tablet mode
Selects face subobjects	...	Shift+F4	Shift+F4	ScrollBar	Toggles the scroll bars
Closes the current drawing	Close	Ctrl+F4 	...	WClose	Closes the current drawing
Closes all drawings and AutoCAD	Quit	Alt+F4 	...	Quit	Closes all drawings and BricsCAD
Cycles through isoplanes	Isoplane	F5	F5	Isoplane	Cycles through isoplanes
Selects solid history	...	Shift+F5	Shift+F5	...	
Toggles dynamic UCS mode	UcsDetect	F6	F6	UcsDetect	Toggles dynamic UCS mode
Switches to the next drawing	...	Ctrl+F6 	Switches to the next drawing
Toggles display of the grid	GridMode	F7	F7	Grid T	Toggles the display of the grid
Toggles orthogonal mode	OrthoMode	F8	F8	Orthogonal T	Toggles orthogonal mode
...	...	Shift+F8 	...	VbaMan	Displays VBA Manager dialog box
Runs VBA macros	VbaRun	Alt+F8 	...	VbaRun	Displays Run BricsCAD VBA Macro dialog box
Toggles snap mode	SnapMode	F9	F9	Snap T	Toggles snap mode
Toggles polar tracking	SnapType	F10	F10	SnapType	Toggles polar tracking
Toggles object snap tracking	PolarMode	F11	F11	PolarMode	Toggles object snap tracking
...	...	Shift+F11	...	AddInMan	Displays the Add-in Manager dialog box
Opens the VBA editor	Vbalde	Alt+F11 	...	VBA	Opens the Visual Basic Editor
Toggles dynamic input	DynMode	F12	F12	QuadDisplay	Toggles the Quad cursor
...	...	Ctrl+F12	Toggles subentity selection mode

 The function is provided by Windows and cannot be customized by BricsCAD

CTRL/CMD KEYS

To operate Ctrl-key shortcuts in Linux and Windows, hold down the **Ctrl** key, and then press the associated character. In Mac, hold down the Cmd key instead.

AutoCAD Action	AutoCAD Command(s)	Windows & Linux		BricsCAD Command(s)	BricsCAD Action
		Shortcut	MacOS Shortcut		
Overrides LockUI	...	Ctrl	Cmd	LockUI	Overrides LockUI
Selects sub-objects					<i>Depends on the currently active command</i>
Toggles Properties palette	Properties, PropertiesOff	Ctrl+1	Cmd+1	Properties, PropertiesOff	Toggles Properties bar
Toggles DesignCenter palette	AdCenter, AdcClose	Ctrl+2	Cmd+2	Explorer	Displays Drawing Explorer
Toggles Tools palette	ToolPalettes, ToolPalettesOff	Ctrl+3		...	
Toggles Sheet Set Manager palette	SheetSet, SheetSetHide	Ctrl+4		...	
Toggles dbConnect palette	dbConnect, dbClose	Ctrl+6		...	
Toggles Markup Set Manager palette	Markup, MarkupClose	Ctrl+7		...	
Toggles QuickCalc palette	QuickCalc, QcClose	Ctrl+8		...	
Toggles Command Line palette	CommandLine, CommandLineHide	Ctrl+9	Cmd+9	CommandLine, CommandLineHide	Toggles command bar
Toggles CleanScreen mode	CleanScreenOn, CleanScreenOff	Ctrl+0	Ctrl+0	CleanScreenOn, CleanScreenOff	Toggles cleanscreen mode
Selects all non-frozen objects	(ai_SelAll)*	Ctrl+A	Cmd+A	SelGrips All	Selects all non-frozen objects
Toggles group mode	**	Ctrl+Shift+A		...	
Toggles snap mode	SnapMode	Ctrl+B	Cmd+B	Snap T	Toggles snap mode
Copies selected objects to Clipboard	CopyClip	Ctrl+C	Cmd+C	CopyClip	Copies selected objects to Clipboard
Copies objects with base point	CopyBase	Ctrl+Shift+C	Cmd+Shift+C	CopyBase	Copies selected objects with base point
Toggles dynamic UCS	UcsDetect	Ctrl+D		...	
Switches to the next isoplane	Isoplane	Ctrl+E	Cmd+E	Isoplane	Switches to next isoplane
Toggles object snap mode	OsMode	Ctrl+F	Cmd+F	Find	Displays Find and Replace dialog box
Toggles display of the grid	GridMode	Ctrl+G	Cmd+G	Grid T	Toggles display of the grid
Toggles pick style	PickStyle	Ctrl+H	Cmd+H	PickStyle	Toggles pick style
Toggles display of open palettes	HidePalettes	Ctrl+Shift+H		...	
Cycles thru coordinate display modes	Coords	Ctrl+I	Cmd+I	Coords	Cycles through coordinate display modes
Toggles constraint inference	**	Ctrl+Shift+I		...	
Repeats the last command	**	Ctrl+J	Cmd+J	;	Repeats the last command
Displays the Hyperlink dialog box	Hyperlink	Ctrl+K	Cmd+K	Hyperlink	Displays Hyperlink dialog box
Toggles orthographic mode	OrthoMode	Ctrl+L	Cmd+L	Orthogonal T	Toggles orthographic mode
Selects previous selection set	**	Ctrl+Shift+L	Cmd+Shift+L	LookFrom	Toggles look-from viewpoint gadget
Repeats the last command	**	Ctrl+M		;	Repeats the last command
Displays Select Template dlg box	New	Ctrl+N	Cmd+N	New	Displays the New Drawing dialog box

AutoCAD Action	AutoCAD Command	Windows & Linux Shortcut	MacOS Shortcut	BricsCAD Command	BricsCAD Action
Displays the Select File dialog box	Open	Ctrl+O	Cmd+O	Open	Displays the Open Drawing dialog box
Displays the Plot dialog box	Plot	Ctrl+P	Cmd+P	Print	Displays the Print dialog box
Toggles Quick Properties palette	QpMode	Ctrl+Shift+P	Cmd+Shift+P	OpmState	Toggles the Properties bar
Closes drawings and AutoCAD	Quit	Ctrl+Q	Cmd+Q	Quit	Closes drawings and BricsCAD
Cycles through viewports	^V **	Ctrl+R	...	^V	Cycles through viewports
Saves the current drawing	Qsave	Ctrl+S	Cmd+S	QSave	Saves the current drawing
Displays Save Drawing As dlg box	SaveAs	Ctrl+Shift+S	Cmd+Shift+S	SaveAs	Displays the Save Drawing As dialog box
Toggles tablet mode	Tablet	Ctrl+T	Cmd+T	Tablet T	Toggles tablet mode
Toggles polar tracking	SnapType	Ctrl+U	
Pastes objects from Clipboard	PasteClip	Ctrl+V	Cmd+V	PasteClip	Pastes entities from Clipboard
Pastes objects as block from Clipboard	PasteBlock	Ctrl+Shift+V	Cmd+Shift+V	PasteBlock	Pastes entities from Clipboard as a block
		Ctrl+Alt+V	Cmd+Opt+V	PasteSpec	Displays the Paste Special dialog box
Toggles selection cycling	**	Ctrl+W	Cmd+W	WClose	Closes the current drawing
Cuts selected objects to Clipboard	CutCut	Ctrl+X	Cmd+X	CutClip	Cuts selected entities to Clipboard.
Redoes the last undo	Redo	Ctrl+Y	Cmd+Y	Redo	Redoes the last undo
Undoes the last command	U	Ctrl+Z	Cmd+Z	U	Undoes the last command
Cancels current command	Esc	Ctrl+[Cmd+[^C	Cancels current command
Cancels current command	Esc	Ctrl+\	Cmd+]	^C	Cancels current command
...		Home	Home		Resets the 3D view to home view
Displays layout tab to the left of the current one	Layout Set	Ctrl+PageUp	
Displays layout tab to the right of the current one	Layout Set	Ctrl+PgDown	
Move left through drawings tabs	**	Ctrl+Left	
Move right through drawing tabs	**	Ctrl+Right	

*) AutoCAD uses an AutoLISP routine for this function.

**) AutoCAD uses an undocumented command for this function.

SHIFT KEYS

Shift keys are temporary overrides in AutoCAD that operate object snaps during commands. **Shift** key-combinations are not supported by BricsCAD.

AutoCAD Action	AutoCAD Command	Shortcut Keystroke	BricsCAD Command	BricsCAD Action
Toggles orthogonal mode	Ortho	Shift	Orthographic	Toggles orthogonal mode
Toggles object snap mode	OsMode	Shift+A	...	
Overrides object snap: Center	-OSnap Cen	Shift+C	...	
Disables all snapping and tracking	-OSnap Non	Shift+D	...	
Overrides object snap: Endpoint	-OSnap End	Shift+E	...	
Disables all snapping and tracking	Orthomode Osmode Snapmode Autosnap	Shift+L	...	
Overrides object snap: Midpoint	-OSnap Mid	Shift+M	...	
Overrides object snap: Endpoint	-OSnap End	Shift+P	...	
Toggles object snap tracking mode	PolarMode	Shift+Q	...	
Enables object snap enforcement	OsnapOverride	Shift+S	...	
Overrides object snap: Midpoint	-OSnap Mid	Shift+V	...	
Toggles navigation wheel	NavSWheel	Shift+W	...	
Toggles polar mode	AutoSnap	Shift+X	...	
Toggles dynamic UCS mode	UcsDetect	Shift+Z	...	
Overrides object snap: Center	-OSnap Cen	Shift+,	...	
Enables object snap enforcement	OsnapOverride	Shift+;	...	
Toggles polar mode	AutoSnap	Shift+.	...	
Toggles object snap mode	-OSnap Off	Shift+'	...	
Toggles object snap tracking mode	PolarMode	Shift+]	...	
Toggles dynamic UCS mode	UcsDetect	Shift+/ /	...	

OTHER KEYS

These shortcut keystrokes do not work in the Mac version of BricsCAD.

AutoCAD Action	AutoCAD Command	Shortcut Keystroke	BricsCAD Command	BricsCAD Action
Erases selected objects	Erase	Del	Erase	Erases selected objects
...	...	PageUp	Pan PgU	Pans up
...	...	PageDown	Pan PgD	Pans down
...	...	Shift+Left	Pan PgL	Pans left
...	...	Shift+Right	Pan PgR	Pans right
...	...	Shift+Up	Pan PgU	Pans up
...	...	Shift+Down	Pan PgD	Pans down

Keyboard Shortcuts for Command Bar & Text Window

The following keyboard shortcuts operate on text in the command bar and Text window.

AutoCAD Action	Windows & Linux Keystroke	MacOS Keystroke	BricsCAD Action
Executes the command or option	Enter or Spacebar	Enter or Spacebar	Executes the command or option
Repeats the previous command	Enter or Spacebar	Enter or Spacebar	Repeats the previous command
Cancels the command or option	Esc	Esc	Cancels the command or option
Displays previous command	Up	...	Displays previous command
Displays next command in command history	Down	...	Displays next command in command history
Moves cursor to the left	Left	...	Moves cursor to the left
Moves cursor to the right	Right	...	Moves cursor to the right
Moves cursor to the start of the command line	Home	...	Moves cursor to the start of the command line
Moves cursor to the end of the command line	End	...	Moves cursor to the end of the command line
Toggles between insertion and overwrite mode	Ins
Deletes characters to the right of the cursor	Del
Deletes characters to the left of the cursor	Backspace	Backspace	Deletes characters to the left of the cursor
Selects all text in Text window	Ctrl+A	Cmd+A	Selects all text in Text window
Copies selected text to Clipboard	Ctrl+C	Cmd+C	Copies selected text to Clipboard
Pastes text from Clipboard to command prompt	Ctrl+V	Cmd+V	Pastes text from Clipboard to command prompt
Cuts text from command prompt to Clipboard	Ctrl+X	Cmd+X	Cuts text from command prompt to Clipboard

As an alternative to these keystrokes, in BricsCAD you can right-click the command bar and then choose an action from the shortcut menu.

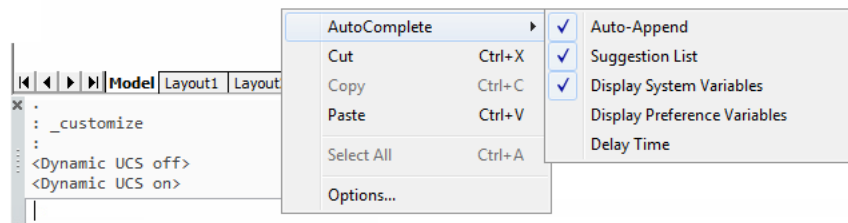

Mouse and Tablet Buttons

The following tables compare the actions of mouse and tablet buttons in AutoCAD and BricsCAD. For BricsCAD, these buttons work identically in the Windows, Mac, and Linux versions.

MOUSE BUTTONS

AutoCAD customizes the definitions of mouse buttons in the **Mouse Buttons** and **Double-click Actions** nodes of its **CUI** command (Customize User Interface dialog box).

BricsCAD customizes mouse and double-click buttons in the **Mouse** tab of the **Customize** command (Customize dialog box).

AutoCAD Action	Mouse Button Number	BricsCAD Action
Picks objects *	1 (left button)	Picks objects *
Displays grips shortcut menu	2 (right)	Repeats the last command
Displays object snap shortcut menu	3 (center)	Displays object snap shortcut menu
Cancels the current command	4	...
Toggles snap mode	5	...
Toggles ortho mode	6	...
Toggles grid display	7	...
Changes the coordinate display	8	...
Switches to the next isoplane	9	...
Toggles tablet mode	10	...
Zooms in real time *	Wheel	Zooms in real time *
Edits selected object(s)	Double-click 1 (left button)	Edits selected object(s)
Displays object snap shortcut menu	Shift+2 (right)	Displays object snap shortcut menu
Rotates viewpoint in 3D	Shift+3 (center)	...
...	Ctrl+1 (left)	...
Displays object snap shortcut menu	Ctrl+2 (right)	Rotates viewpoint in 3D
Swivels viewpoint in 3D	Ctrl+3 (middle)	...
Zooms viewpoint in 3D	Ctrl+4	...

*) The action of the pick button (#1) and wheel cannot be customized.

TABLET BUTTONS

AutoCAD lets you customize the definitions of stylus and puck buttons in the **Tablet Buttons** node of its Customize User Interface dialog box's **Legacy** section.

BricsCAD lets you customize buttons in the **Digitizer Buttons** node of the Customize dialog box's **Tablet** tab. However, no tablet menu or partial CUI file is provided by BricsCAD, and so the entries under Digitizer Buttons and Tablet Menus are empty, initially. The solution is to the following:

1. Download the set of partial CUI files and drawings for tablet buttons and overlays from <https://www.bricsys.com/bricscad/tools/Tablet.zip>.
2. Load the `tablet.cui` or `tablet(acadLike).cui` partial CUI files into BricsCAD with the **MenuLoad** command.

Notice that the two sections now contain entries for tablet buttons and menus. These work identically for the Windows, Mac, and Linux versions of BricsCAD.

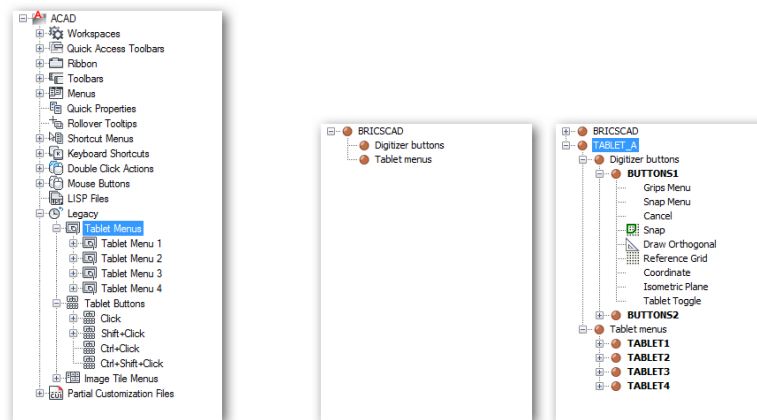

*Left: Tablet button definitions in AutoCAD's CUI dialog box.
Center: Default tablet definition in BricsCAD's Customize dialog box.
Right: Tablet definition in BricsCAD after loading "tablet(acadLike).cui."*

The following table lists the meaning of stylus and puck buttons used with tablets. Italicized text indicates the actions after partial CUI file `tablet(acadLike).cui` is loaded into BricsCAD.

AutoCAD Action	Tablet Button	BricsCAD Command	BricsCAD Action
Picks objects	1	...	Picks objects
Displays grips shortcut menu	2	<code>\$po=GRIPS \$po=*</code>	Displays grips shortcut menu
Displays object snap shortcut menu	3	<code>\$po=SNAP \$po=*</code>	Displays object snap shortcut menu
Cancels the current command	4	<code>^c</code>	Cancels the current command
Toggles snap mode	5	<code>'_snap;_t</code>	Toggles snap mode
Toggles ortho mode	6	<code>'_orthogonal;_t</code>	Toggles ortho mode
Toggles grid display	7	<code>'_grid;_t</code>	Toggles grid display
Changes the coordinate display	8	<code>'_COORDS \$M=\${if,\$(and,\$(getvar,COORDS),2),0,\$(+,\$(getvar,COORDS),1)}</code>	Changes the coordinate display
Switches to the next isoplane	9	<code>'_isoplane;;</code>	Switches to the next isoplane
Toggles tablet mode	10	<code>'_tablet;_t</code>	Toggles tablet mode
Displays object snap shortcut menu	Shift+2	<code>\$po=SNAP \$po=*</code>	Displays object snap shortcut menu

The tablet overlay provided by Bricsys is illustrated below.

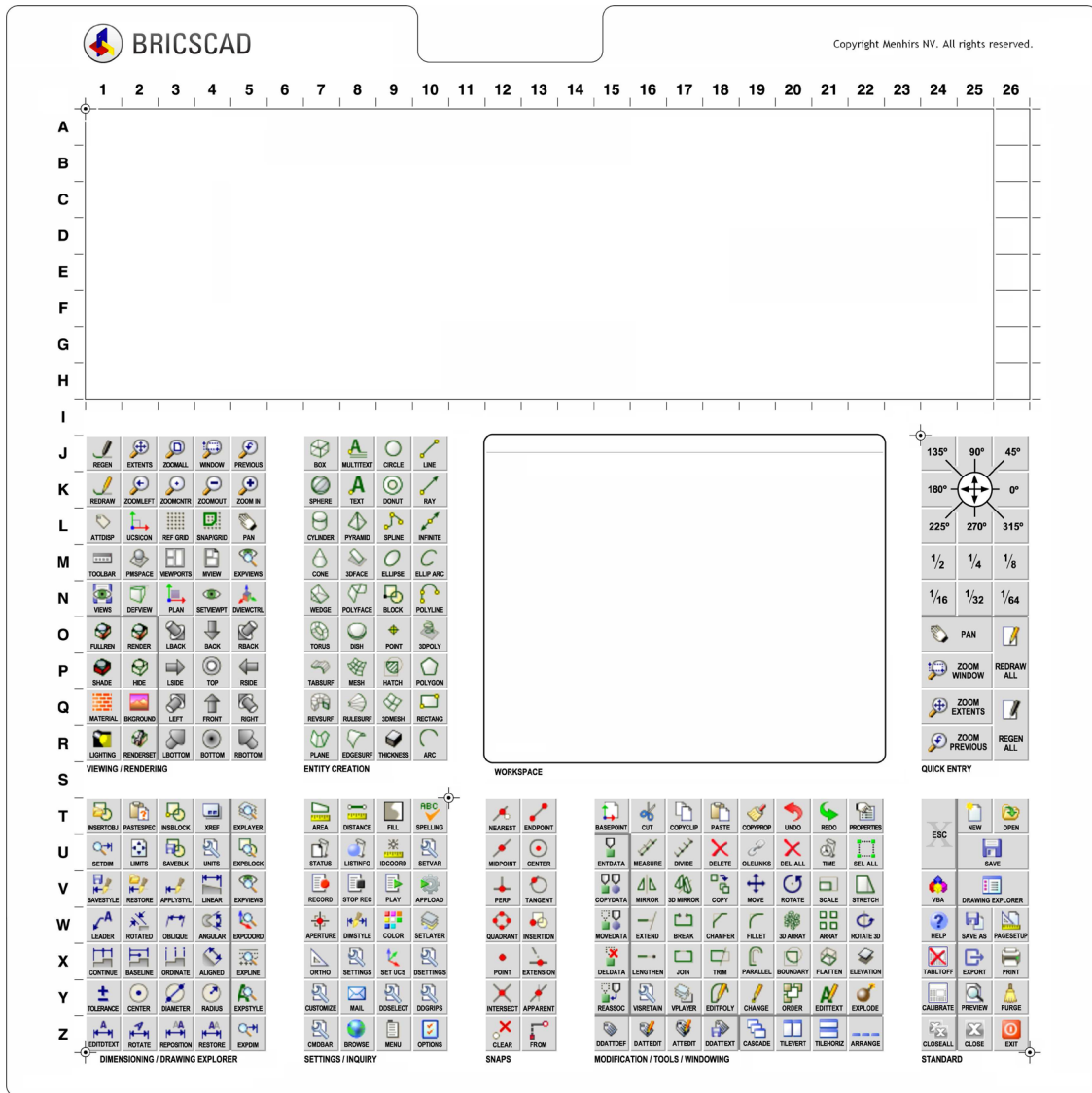

NAVIGATE & 3D WALK-FLY CONTROLS

AutoCAD and BricsCAD use keystrokes and mouse buttons to control movement in 3D perspective mode, known also as “navigate” and “walk and fly” modes. (Walk mode freezes the z-coordinate.) The keys and buttons used by the two CAD packages are so different that I present them separately here. You cannot customize navigate, walk, or fly controls.

Navigate

Enter navigate mode by entering the Navigate command. These keystrokes work in Linux, MacOS, and Windows.

AutoCAD & BricsCAD Function	Keystroke	Alternative Keystroke	Mouse Button
Move forwards	w	Up-arrow	
Move backwards	s	Down-arrow	
Move to the left	a	Left-arrow	
Move to the right	d	Right-arrow	
Toggle between walk-fly mode	f	...	
Zoom in and out	Roll scroll wheel
Pan left, right, up, down	Hold down left button
Display Settings dialog box (BricsCAD only)	Right-click
Display shortcut menu (AutoCAD only)	
Display Keystrokes help (AutoCAD only)	Tab	...	
Exits walk-fly mode	Esc	Enter	

Walk & Fly

Enter walk or fly mode with the **3dWalk** and **3dFly** commands.

Function	Windows & Linux Key+Button	MacOS Key+Button	BricsCAD Command or System Variable Executed
Moves forward, backwards, left, or right	Alt + Left button	Opt + Left button	RtWalk
Moves up, down, or sideways	Alt + Middle button	Opt + Middle button	RtUpDown
Looks around	Ctrl + Middle button	Cmd + Middle button	RtLook
Resets view direction to the horizontal	Ctrl + Home key	Cmd + Home key	...
Moves target point to the center of the scene	Alt + Home key	Opt + Home key	...
Increases walking speed	Alt + Plus key	Opt + + (plus key)	RtWalkSpeedFactor
Decreases walking speed	Alt+Minus key	Opt + - (minus)	RtWalkSpeedFactor
Increases rotation speed	Ctrl + Plus key	Cmd + + (plus)	RtRotationSpeedFactor
Decreases rotation speed	Ctrl+Minus key	Cmd + - (minus)	RtRotationSpeedFactor

3D MOUSE CONTROLS AND BUTTONS

AutoCAD and BricsCAD both support 3D mice made by 3Dconnexion. Before the CAD programs can recognize the mouse, however, the 3Dconnexion device driver must be installed on your computer. The driver software is included with the mouse, but if you mislaid the CD, then you can download it from <http://www.3dconnexion.com> for computers running recent releases of Windows, MacOS, and Linux. You may need to reboot the computer after installing the driver.

BricsCAD Customization

The actions of the 3D mouse's buttons and cap are defined by the 3Dconnection Properties software. There are no controls in BricsCAD, with the sole exception of the **Ctrl3DMouse** variable, which enables and disables the 3D mouse.

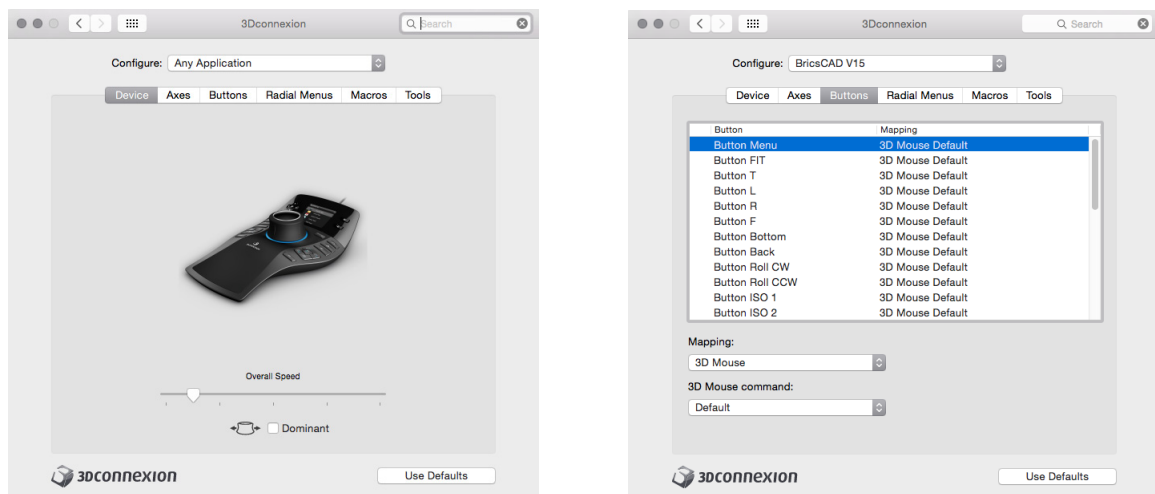

Settings for multi-button SpacePilot Pro mouse

In practice, you use both mice: the regular “2D” mouse for choosing commands and picking objects, and the puck of the 3D mouse for moving the viewpoint in 3D. Users typically move the regular mouse with the right hand, and the 3D mouse with the left.

The 3D mouse cannot be customized by BricsCAD's Customize | Mouse dialog box. Instead, you program buttons to execute specific BricsCAD commands through the 3Dconnection Properties software. The screen grabs above illustrate the default settings of the buttons.

Setting Up Network Licenses

THIS APPENDIX ASSISTS YOU IN INSTALLING AND SETTING UP OF THE BRICSCAD NETWORK License Manager. The following video gives you an overview of the Network License Manager set up for Windows: <https://blog.bricsys.com/bricscad-license-server-setup/>

This appendix covers the following topics:

- › Creating a user account with Bricsys
- › Installing the network license manager
- › Manual Activation
- › Upgrading or replacing existing licenses
- › Adding additional licenses
- › Management
- › Deployment
- › License roaming

This appendix was compiled by CAD Concepts, a BricsCAD dealer in Auckland, New Zealand, and is reproduced with permission. <http://www.cadconcepts.co.nz>

Bricsys User Account

If you've been requested to install and manage this on behalf of the license owner, such as your boss, then we recommend that the first thing you do is to create a user account with Bricsys. This provides you with two advantages:

Firstly, it allows the license holder to assign you as the Licence Manager, meaning you can manage their BricsCAD licenses on their behalf.

Secondly, should you encounter any problems with administering the network license, you have direct access next-business-day support from Bricsys.

To create an account with Bricsys go to <https://www.bricsys.com/register/>

NLM Installation

The Network License Manager can be downloaded and installed by taking the following steps:

1. Download the Network License Manager
For Windows from <https://www.bricsys.com/bricscad/tools/Bricsys-NetworkLicenseManager.msi>
For Linux from <https://www.bricsys.com/bricscad/tools/Bricsys-NetworkLicenseManager.tgz>
MacOS has no license manager available
2. Follow the advice in BricsCAD help on network license setup at <https://help.bricsys.com/hc/en-us/articles/360006428594-Network-license-server>
3. Provided your server has internet access, you can then activate the license during the installation process.
4. Check the communication with the license manager over the network. It is common to make adjustments to the firewall and antivirus settings on both the server and client machines to allow the licence manager to communicate over the network.

NOTE If you made changes to your system's firewall and/or antivirus arrangement, then we recommend that you configure the license manager to use a static port. (The license manager assigns itself a port by default on startup, automatically). Instructions on how to do this are given by BricsCAD help at <https://help.bricsys.com/hc/en-us/articles/360006531393-Advanced-configuration>.

Manual Activation

If you don't have direct Internet access from your target server, then you need to do a manual activation. We recommend that you authenticate your licenses against the ethernet adapter card (a.k.a. MAC address) of your server, rather than the hard disk, as the MAC (media access control) address is less likely to change.

To find the hostid for manual activation:

1. To get the MAC/HostID for manual activation, copy it from the dialogue shown by the Activate Network License manager:

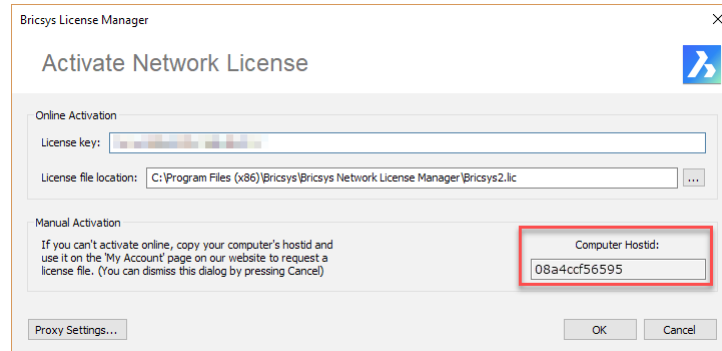

2. Having determined the hostid, you can now carry out a [manual activation](https://www.bricsys.com/bricscad/help/en_US/Current/BricsCAD/source/NetworkLicenseManualActivation.htm) of your license. See https://www.bricsys.com/bricscad/help/en_US/Current/BricsCAD/source/NetworkLicenseManualActivation.htm

Previous versions of the license manager used the disk serial number by default as a signature to tie the network license to. This proved to be problematic as servers tend to use more exotic disk arrangements and so the disk serial number may change. Using the MAC address has proven to be a lot less problematic.

Upgrading & Replacing Existing licenses

When your firm has an active maintenance agreement, you will be issued with new BricsCAD activation keys automatically on release of the newest version. Currently, this occurs annually around the end of October or early November.

Occasionally an existing license activation will be affected by an update to the host server. This could be due to a hardware change or software service update. In this case you need to replace your existing license activation.

Network licenses are backwards compatible, meaning that the license server will work with all versions of BricsCAD as far back as V14. This means you can update the license on the network server independently the BricsCAD versions installed on client machines.

Steps to upgrade or replace an existing license:

1. We recommend that you first download and install the latest version of the network license manager. This ensures that you have the latest version installed.

- (Skip this step when you are upgrading.) If you're replacing an existing activation due to a problem, then you need to first log in to your Bricsys account (<https://www.bricsys.com/login>) and revoke the current activation. This makes the license available for activation again.

NOTE You can manually revoke a license activation only twice. When you exceed this number, you need to raise a support request with Bricsys for assistance.

- Delete any existing *Bricsys.lic* files related to the previous version from the installation folder. For Windows these files are usually found in *C:\Program Files (x86)\Bricsys\Bricsys Network License Manager*.

NOTE This is an important step. If you don't delete the license files, then users may have issues accessing licenses, resulting in error code -6. Also, It is a breach of your license agreement.

- From the Windows **Start** menu, run the **License Activation** program (*actNetworkLicense.exe*).

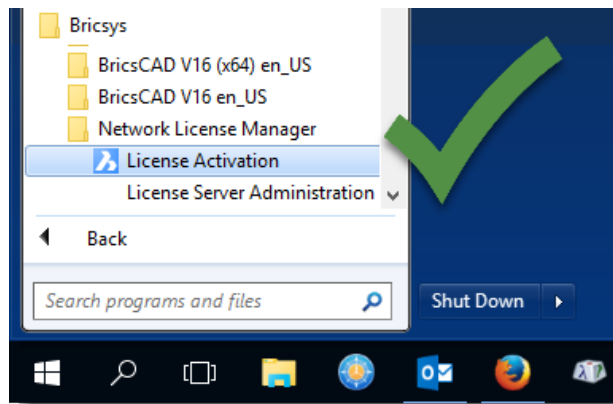

- Input your new license key to activate the software. This create a new *Bricsys.lic* file in the installation folder.

NOTE Do not use the Web interface for this task!

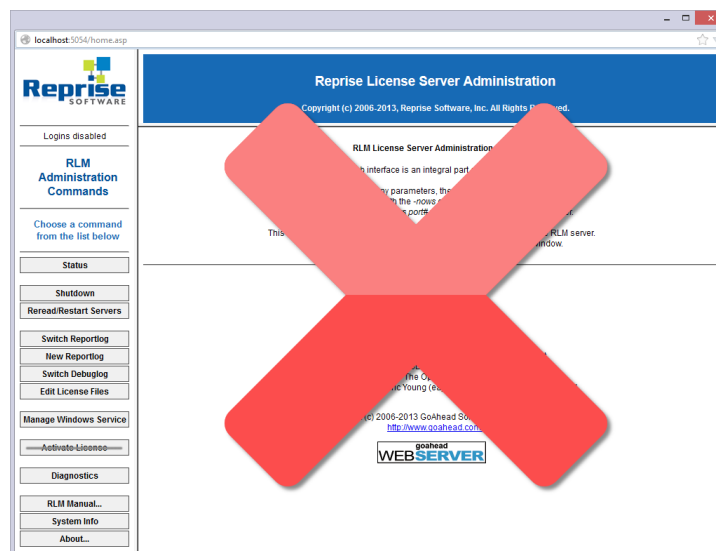

- From the Web interface (<http://localhost:5054>), reread / restart the license server.

ADDING ADDITIONAL LICENSES

If you have purchased additional network licenses, then they can be added to the server pool by re-running License Activation application from the Windows Start menu. Again, do not use the web interface for this task!

Manually Adding Licenses

When you need to do a manual activation, then follow the instructions in Section 2 to get your license file. Once you have the license file, copy it to the correct location on the server. The license file is normally stored in the network license manager installation folder. On Windows, this is usually *C:\Program Files (x86)\Bricsys\Bricsys Network License Manager*.

The license file is named *Bricsys.lic* by default. To add additional license files, simply suffix a number on the end, such as *Bricsys.lic*, *Bricsys2.lic*, and *Bricsys3.lic*.

Having added the additional license(s), you need to re-start the license server to make it available. This can be done via the Web interface at <http://localhost:5054>.

For MacOS Users

While Macintosh computers cannot run the Network License Manager, MacOS users nevertheless can access network licenses served by Windows or Linux servers, as noted in the help

<https://help.bricsys.com/hc/en-us/articles/360006428594-Network-license-server>

Network Management

As part of setting up a BricsCAD network license, we recommended that you set up an Options file. Creating the Options file provides you with a way to monitor usage through logging reports, as well as provide you with options to control use of the software.

1. You access the *Bricsys.opt* file via the Web interface using the **Options Bricsys** button, highlighted below.

Reprise License Server Administration
Copyright (c) 2006-2015, Reprise Software, Inc. All Rights Reserved.

Status for "rlm" on CCL-003 (port 5053)

RLM software version	v12.2 (build2)
RLM comm version	v1.2
debug log file	rlm.log
license files	Bricsys.lic

rlm Statistics	Since Start	Since Midnight	Recent
Start time	03:13 10:23:52	03:13 10:23:53	03:13 10:23:53
Messages	10 (0/sec)	10 (0/sec)	10 (0/sec)
Connections	5 (0/sec)	5 (0/sec)	5 (0/sec)

EDIT rlm...
SHOW rlm...

ISV Servers	Name	port	Running	Restarts	Server Status	License Usage	Debug Log	REREAD	OPTIONS	TRANSFER	SHUTDOWN	ACTIVATE
bricsys	49668	Yes	0	bricsys	bricsys	bricsys	bricsys	bricsys	bricsys	bricsys	bricsys	bricsys

2. Once finished, click the **Read/Restart Servers** button to update the server.

To help you get started, we have provided an example Options file:

```
## BRICSYS.OPT
## See http://www.reprisesoftware.com/RLM\_License\_Administration.pdf
##-----
## LOGS
## REPORT LOG
## Set Report Log Location
#REPORTLOG "+D:\BCAD\Log\Net_Reportlog.log" detailed
## Rotate the report log
#ROTATE daily
## Purge old report logs after xx days.
## This option won't work on Windows Servers, only works on Unix/Linux
#PURGE_REPORTLOG 30
## DEBUG LOG
## Set Debug Report Log Location
#DEBUGLOG "+D:\BCAD\Log\Net_Debuglog.log"
##-----
## GROUPS
## Set grouping levels
#HOST_GROUP engineer engineering-users
#HOST_GROUP cad cad-users
##-----
## ROAMING
## Set the max number of seats that can be roamed
## Setting to 0 disables roaming.
#ROAM_MAX_COUNT 1 bricscad
## set the max days allowed to roam. Default=5
#ROAM_MAX_DAYS 5 bricscad
## Define who can & can't roam
# EXCLUDEALL_ROAM HOST_GROUP engineer
# INCLUDEALL_ROAM HOST_GROUP cad
##-----
```

All the lines in the file are commented out “#” by default. To help with readability, we used a double “##” for any lines that are actual comments, and a single “#” for command options. For example:

SETTING UP A REPORT LOG

Setting the report log captures data on license usage to a text file in a location of your choice. You need to update the provided options file with your preferred location and filename.

1. Find the following line:
#REPORTLOG "+D:\BCAD\Log\Net_Reportlog.log" detailed
2. Change the path location, and remove the # comment indicator:
REPORTLOG "+ MyServerPath\Net_Reportlog.log" detailed

NOTE The “+” at the start tells the license manager to append (rather than overwrite) the specified file. On Windows, the license manager does not purge old files, and so occasionally you need to do this manually.

Management Resources

You find additional information on managing network licenses from the following sources:

BricsCAD Help Center provides links to download the network server software, and information on installation and management:

<https://help.bricsys.com/hc/en-us/articles/360006428594-Network-license-server>

Bricsys Knowledge Base covers typical issues, and error codes. Please note that this information is likely to be relocated to the Help Centre in the future:

<https://www.bricsys.com/en-intl/support/#85>

RLM License Administration Manual provides more detailed information on the license manager (BricsCAD uses the Reprise license manager):

http://www.reprisesoftware.com/RLM_Enduser.html (1MB PDF file)

RLM FAQ provides answers to commonly-asked questions:

<http://www.reprisesoftware.com/admin/software-licensing-faq.php>

Deployment

Information on deployment can be found at the following locations:

Information on client machine network license configuration is available at <https://help.bricsys.com/hc/en-us/articles/360006528593-Network-license>.

Large organizations may want to automate deployment through silent installation (Windows only). Information for doing this is at

<https://help.bricsys.com/hc/en-us/articles/360006482194-Silent-Installation-Windows-only->

Licenses are valid for use on Windows, Linux, and MacOS. If you are the registered license holder you can view all your licenses using your Bricsys account at <https://www.bricsys.com/login>.

LICENSE ROAMING

BricsCAD Network Licenses include the option to roam with a license, allowing users to continue to access BricsCAD while disconnected from the network. The following video demonstrates how this feature is used: <https://blog.bricsys.com/how-to-roam-with-a-network-license/>.

Further details on roaming can be found at the BricsCAD Help Center:

<https://help.bricsys.com/hc/en-us/articles/360006528593-Network-license#to-roam-a-network-license-on-a-client-computer>.

BRICSCAD USER SUPPORT

The Bricsys website offers many support possibilities:

- ▶ View tutorials on the Bricsys Blog at <https://blog.bricsys.com/>.
- ▶ Take free lessons on how to use BricsCAD through <https://lessons.bricsys.com/>.
- ▶ Visit the help centre at <https://help.bricsys.com/>. If you don't find what you're looking for, then you can raise a support request.
- ▶ There are several helpful ebooks from upFront.eZine Publishing that are available for free. Download them from the <https://help.bricsys.com/> site: scroll down to the bottom left of the help centre.

Download free books and guides



BricsCAD for AutoCAD users	Inside BricsCAD V18	Customizing BricsCAD V18	BricsCAD V19 Brochure
330 pages - English by Ralph Grabowski	386 pages - English by Ralph Grabowski	560 pages - English by Ralph Grabowski	6 pages - English by Bricsys

- ▶ For user-to-user support, participate in the forums at <https://forum.bricsys.com/>.

Key Tips

- ▶ The Network License isn't limited to large organizations; it works for companies with a single network license.
- ▶ Set the server to use a static port to avoid issues with the firewall and antivirus
- ▶ Clean out old .lic files from the network license manager folder when upgrading
- ▶ Set up an Options file to record license usage
- ▶ Update the network license manager with the latest version from the Web site at least once a year

Provided to you by

